

REVISIONS			
REV	DATE	BY	APPD
C2	19JUL2005	DD	GR
C3	19JUL2005	DD	GR

BOM								
QUANTITY		ITEM	DESCRIPTION	SUPPLIER PART NUMBER	MATERIAL SPECIFICATION	RECYCLING CODE	COLOR	WEIGHT (GRAM)
INDEX B	INDEX A							
-	1	1	HOUSING, KEYING OPTION "A"	1438530-1	30% GF PBT	>PBT-GF30<	BLACK	62.0g
1	-	2	HOUSING, KEYING OPTION "B"	1438530-2	30% GF PBT	>PBT-GF30<	NATURAL	62.0g
1	1	3	TPA	1438532-1	15% GF PBT	>PBT-GF15<	RED	4.6g
1	1	4	ALIGNMENT PLATE	1438586-1	15% GF PBT	>PBT-GF15<	NATURAL	2.9g
1	1	5	END SEAL COVER	1438534-1	15% GF PBT	>PBT-GF15<	BLACK	10.4g
1	1	6	END SEAL GROMMET	2203540-1	SILICONE	>VMQ<	GREEN	4.2g

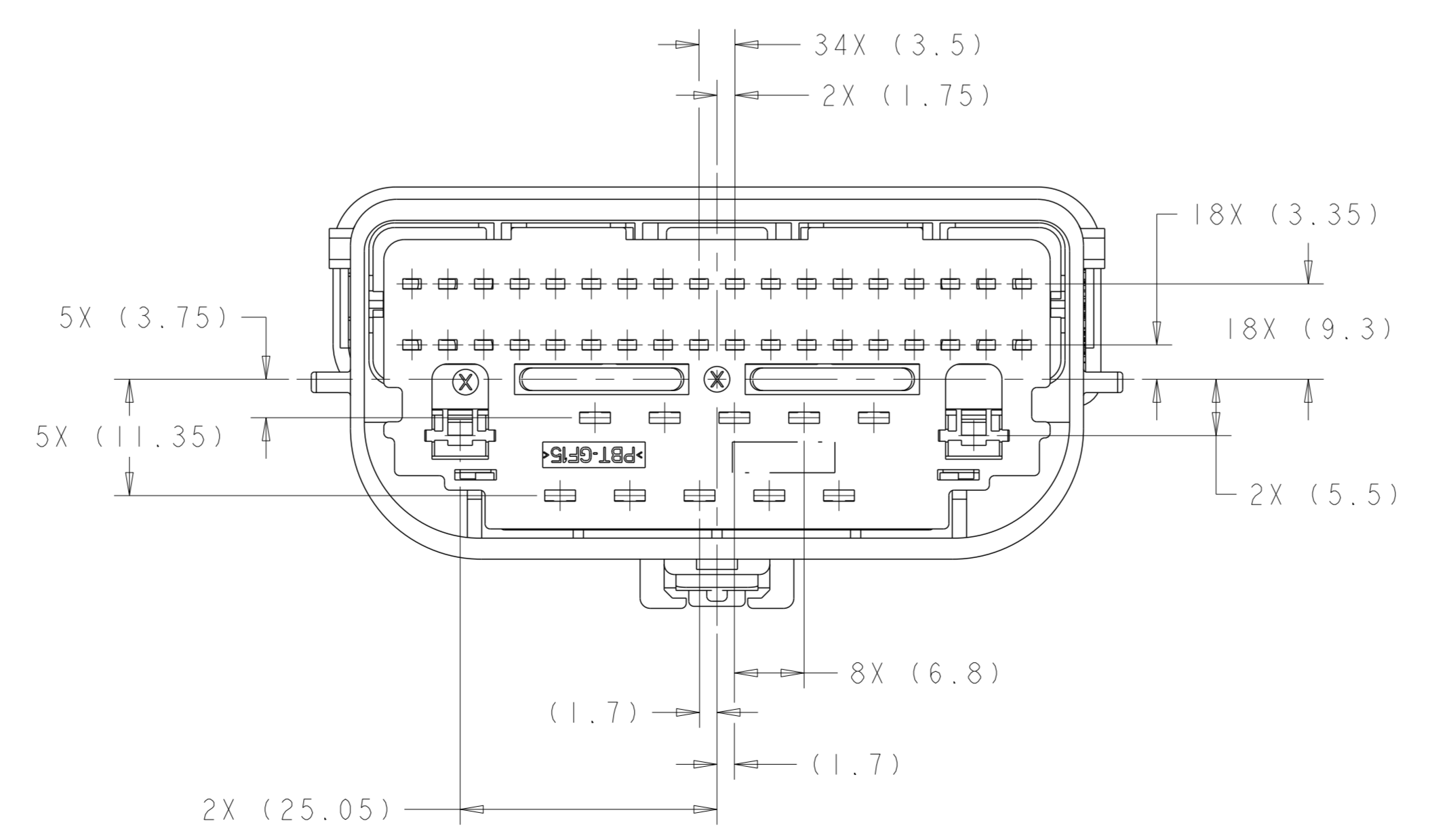
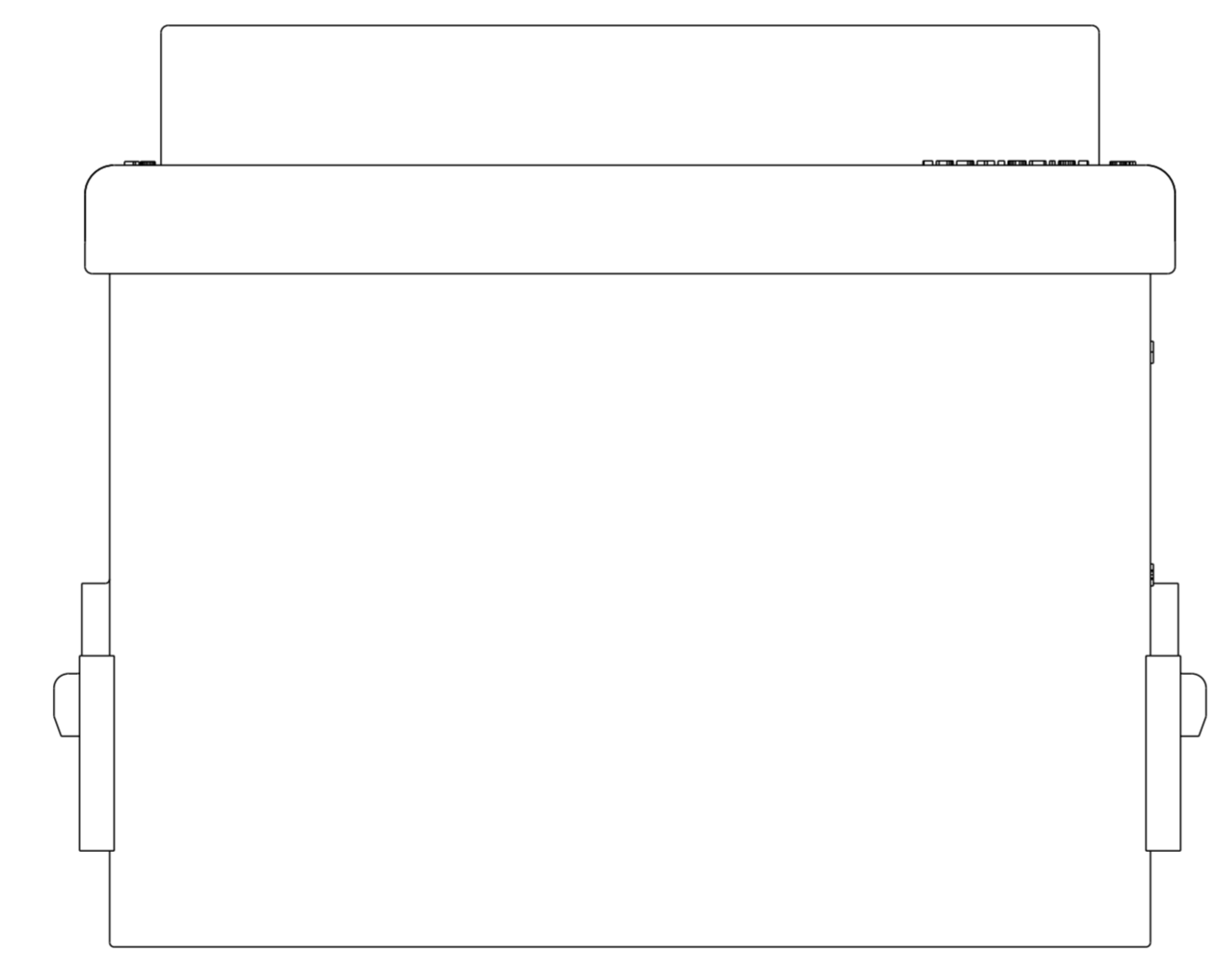
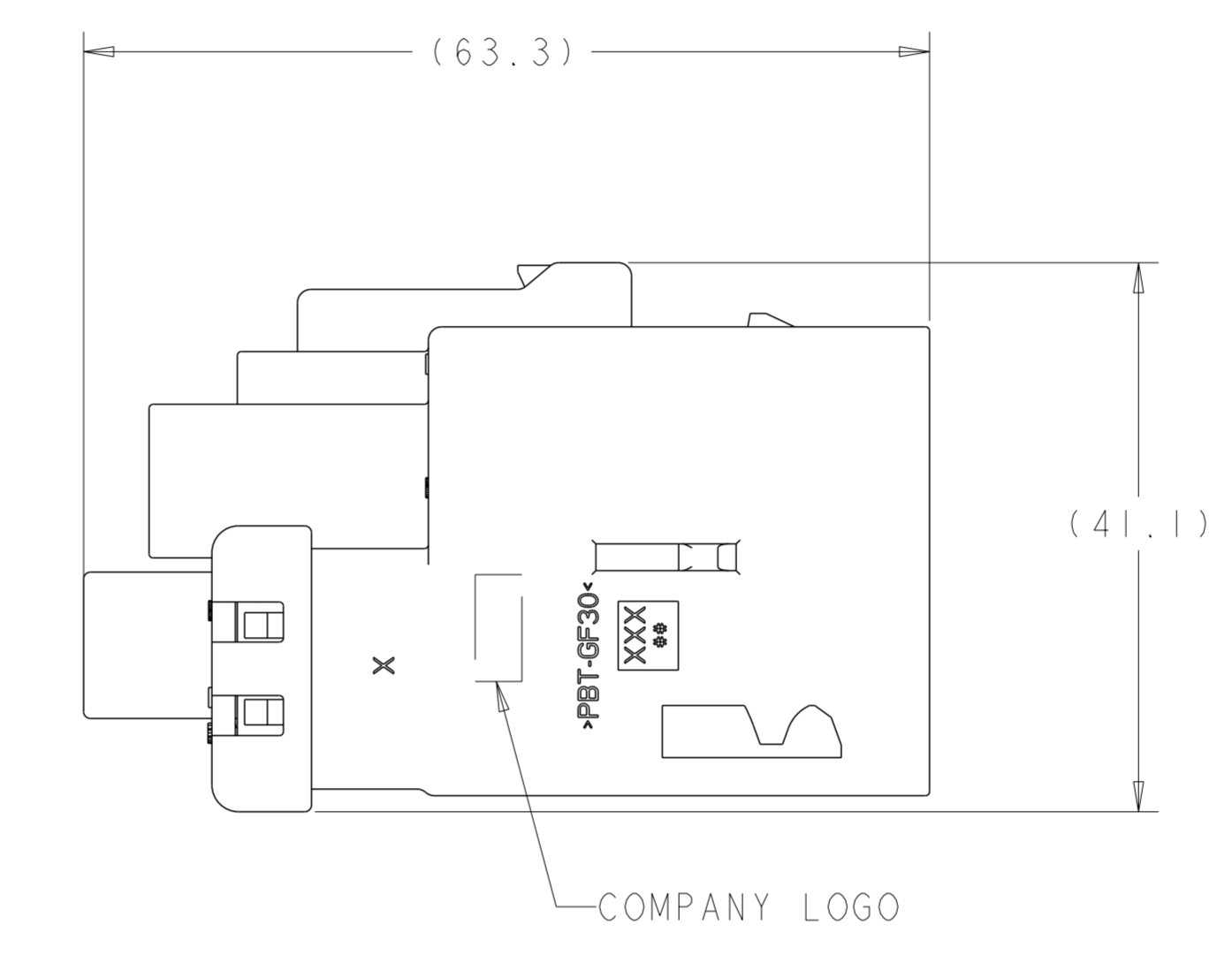
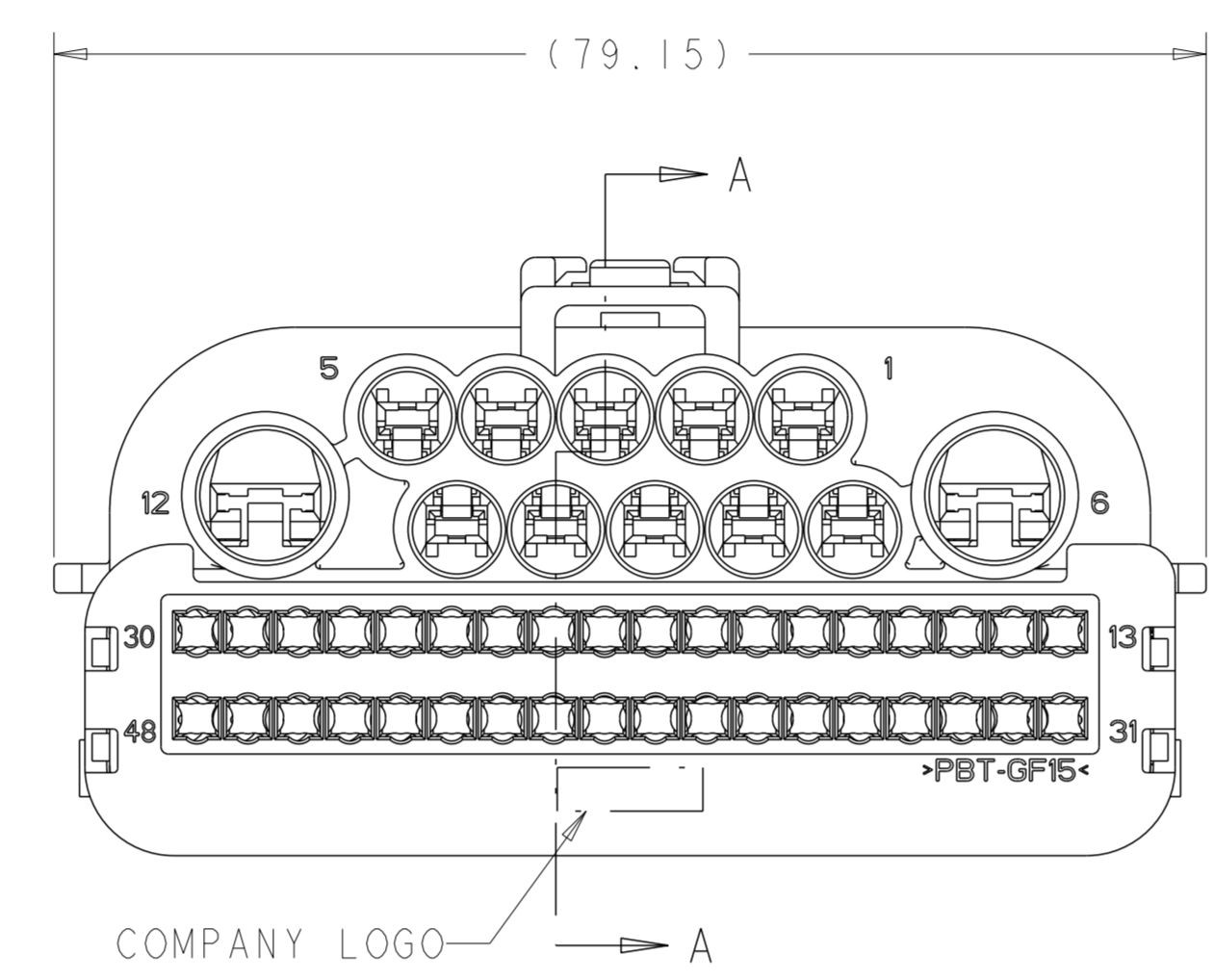
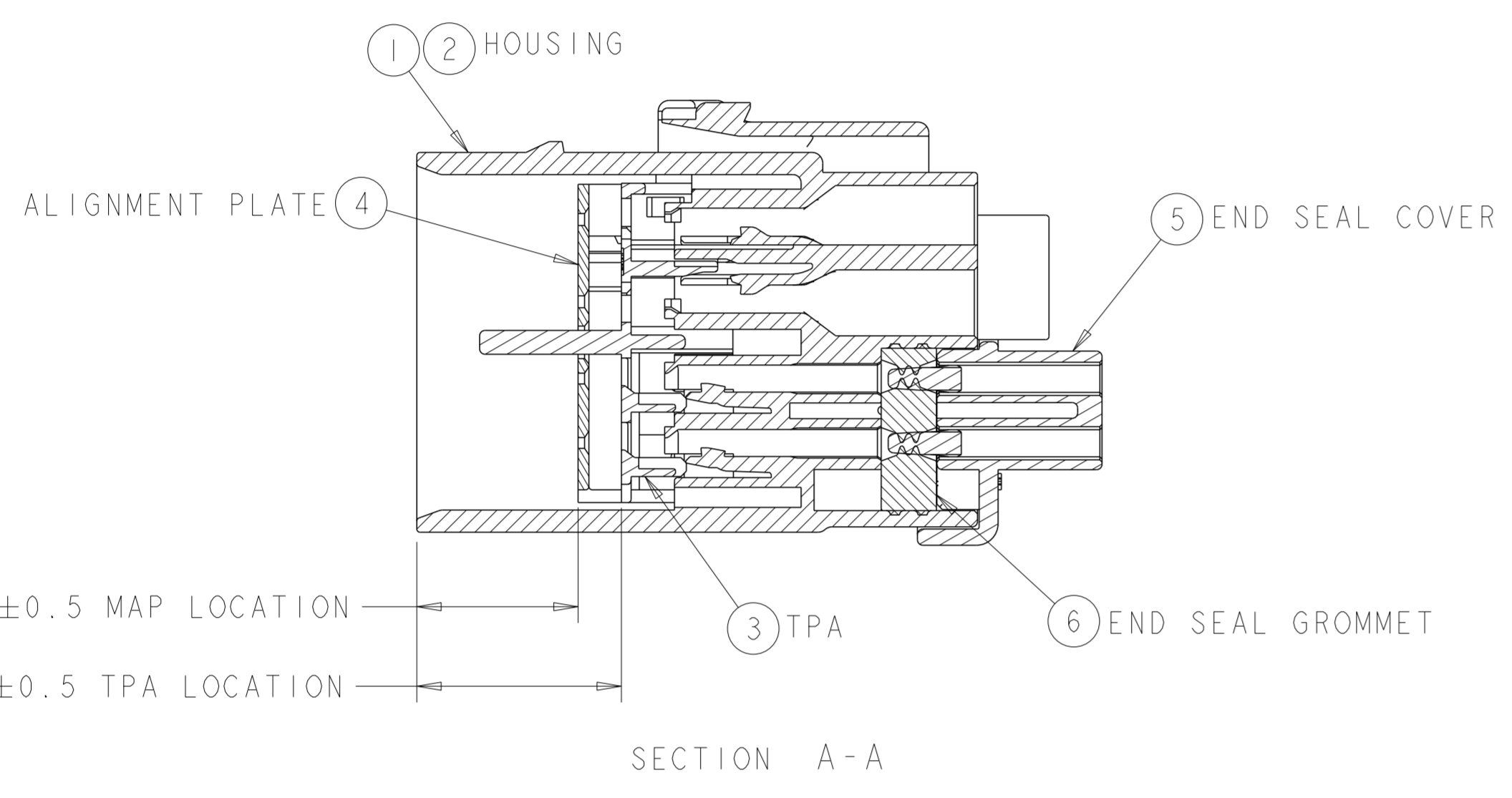
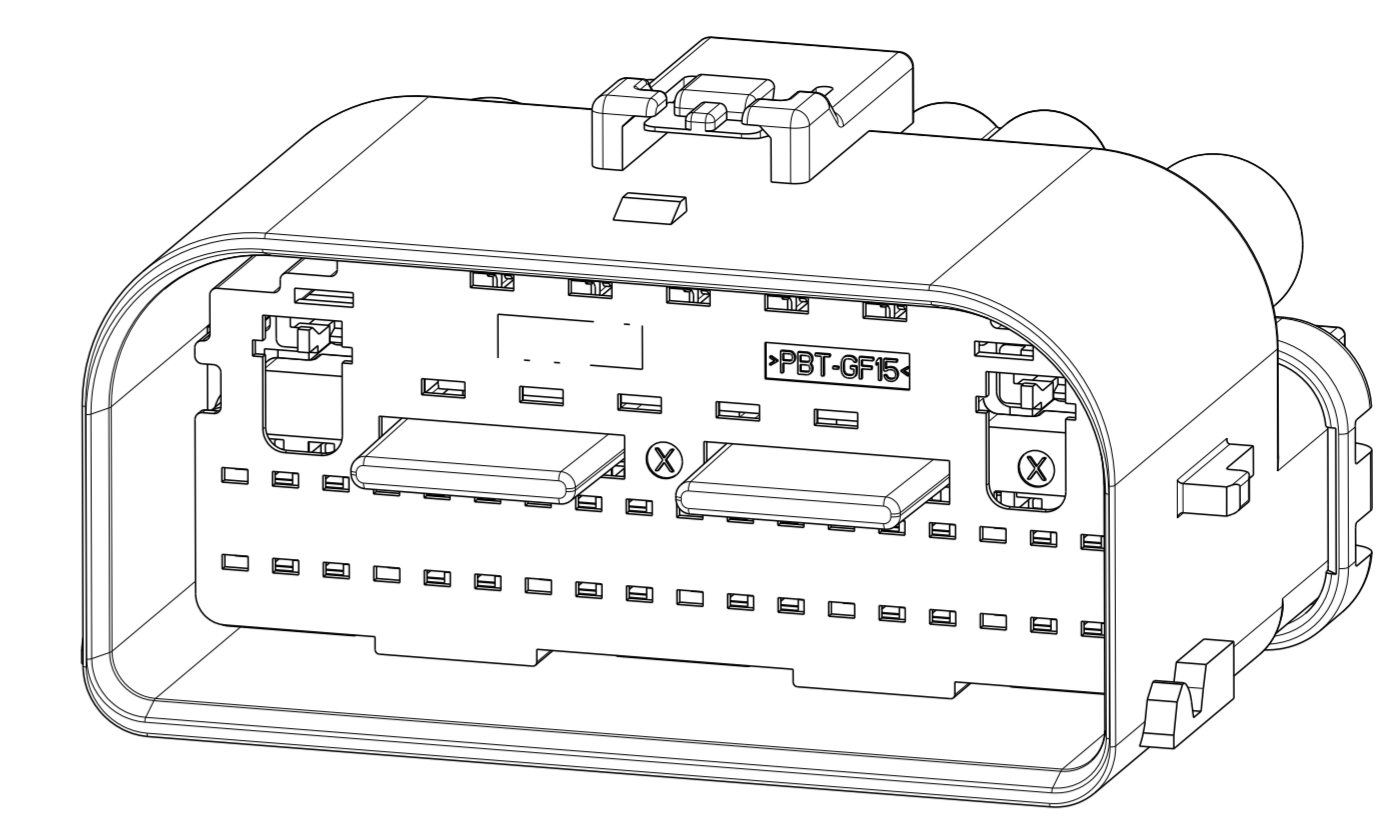
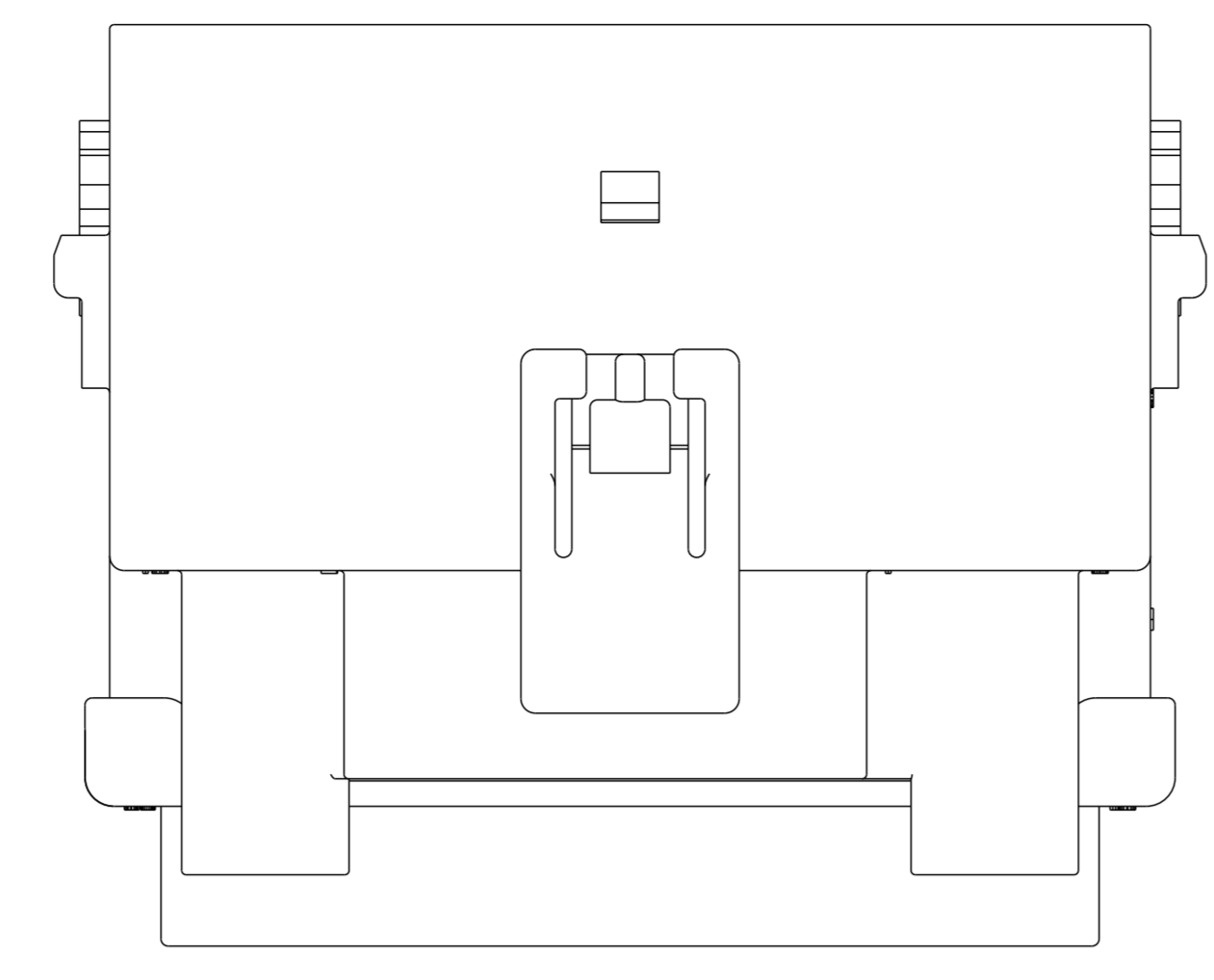

APPLICABLE COMPONENTS (FOR REFERENCE ONLY)				APPLICABLE WIRE SIZES (FOR REFERENCE ONLY)	COMPONENT MATING PART NUMBER
DESCRIPTION	COLOR/PLATING	SUPPLIER	SUPPLIER PART NUMBER		
CAVITY PLUG - 6.3mm	GREEN	YAZAKI	7158-3080-60	N/A	N/A
CAVITY PLUG - 2.8mm	BLUE	YAZAKI	7158-3114-90	N/A	N/A
TERMINAL - MALE 1.5mm	TIN	TE	1488657-1	16 AWG OR METRIC EQUIVALENT	638652-1
TERMINAL - MALE 1.5mm	TIN	TE	1488657-2	18-20 AWG OR METRIC EQUIVALENT	638652-2
TERMINAL - MALE 2.8mm	TIN	TE	1326031-2	20 AWG OR METRIC EQUIVALENT	1326032-2
TERMINAL - MALE 2.8mm	TIN	TE	1326031-3	18 AWG OR METRIC EQUIVALENT	1326032-3
TERMINAL - MALE 2.8mm	TIN	TE	1326031-4	16 AWG OR METRIC EQUIVALENT	1326032-4
TERMINAL - MALE 2.8mm	TIN	TE	1326031-5	14 AWG OR METRIC EQUIVALENT	1326032-5
TERMINAL - MALE 2.8mm	TIN	TE	1-1326031-1	12 AWG OR METRIC EQUIVALENT	1326032-6
CABLE SEAL - 2.8mm	GREEN	YAZAKI	7158-3111-60	1.2-1.9mm WIRE O.D.	N/A
CABLE SEAL - 2.8mm	YELLOW	YAZAKI	7158-3112-70	1.8-2.3mm WIRE O.D.	N/A
CABLE SEAL - 2.8mm	WHITE	YAZAKI	7158-3113-40	2.1-3.0mm WIRE O.D.	N/A
CABLE SEAL - 2.8mm	LT GRAY	YAZAKI	7158-3110-40	3.1-3.3mm WIRE O.D.	N/A
TERMINAL - MALE 6.3mm	TIN	YAZAKI	7114-4140-02	20-16 AWG OR METRIC EQUIVALENT	7116-4140-02
TERMINAL - MALE 6.3mm	TIN	YAZAKI	7114-4141-02	14 AWG OR METRIC EQUIVALENT	7116-4141-02
TERMINAL - MALE 6.3mm	TIN	YAZAKI	7114-4142-02	12 AWG OR METRIC EQUIVALENT	7116-4142-02
TERMINAL - MALE 6.3mm	TIN	YAZAKI	7114-4143-02	10 AWG OR METRIC EQUIVALENT	7116-4143-02
CABLE SEAL - 6.3mm	RED	YAZAKI	7158-3081-50	1.4-2.3mm WIRE O.D.	N/A
CABLE SEAL - 6.3mm	BLUE	YAZAKI	7158-3082-90	2.1-3.0mm WIRE O.D.	N/A
CABLE SEAL - 6.3mm	BLACK	YAZAKI	7158-3083	3.0-3.8mm WIRE O.D.	N/A
CABLE SEAL - 6.3mm	LT GRAY	YAZAKI	7158-3084-40	3.8-4.05mm WIRE O.D.	N/A

NOTE: SEE SUPPLIER DRAWINGS FOR LATEST INFORMATION AND CRIMP SPECIFICATIONS

- PRODUCT QUALIFICATION PER USCAR-2, REV 4. REFERENCE DVP&R B046819-DVPR-03, WITH THE FOLLOWING EXCEPTION:
5.4.3.3: MIN FORCE TO REMOVE CONNECTORS FROM PRE-MATE CONDITION IS 10N.
- PRINT JULIAN DATE CODE (YYDDD), 4 DIGIT PART NUMBER CODE (29***) IN THIS LOCATION AT ASSEMBLY. ** REPRESENTS ASSEMBLY DASH NUMBER. LOCATION TBD.
- MATES WITH ASSEMBLY SHOWN ON DRAWING 776728.
- TPA AND MAP SHOWN IN DELIVERY POSITION. SEE TE INSTRUCTION SHEET 408-8957 FOR PROPER POSITIONING OF TPA AND MAP, AND TE INSTRUCTION SHEET 408-8929 FOR APPLICATION USE OF THE CONNECTOR SYSTEM.
- NOTE DELETED.
- TERMINAL CAVITIES 13 - 48 ARE RESTRICTED TO WIRE O.D. RANGE OF 1.40-2.34mm.

SEE TABLE SHEET 2
PART NUMBER

THIS DRAWING IS A CONTROLLED DOCUMENT.		REV	DATE	BY	APPD
DIMENSIONS: UNLESS OTHERWISE SPECIFIED:		0	19JUL2005	DD	GR
MATERIAL:		1	19JUL2005	DD	GR
FINISH:		2	19JUL2005	DD	GR
APPROVALS:		3	19JUL2005	DD	GR
CUSTOMER DRAWING		4	19JUL2005	DD	GR

STE TE Connectivity
 CAP ASSEMBLY, 48-WAY, SEALED, HYBRID, MALE
 00779 776729
 SCALE: 2:1 SHEET 1 OF 2

