

**75 V, 85 A, 5.3 mΩ Low RDS(ON)  
N ch Trench Power MOSFET  
SKI07074**



**Features**

- $V_{(BR)DSS}$  ----- 75 V ( $I_D = 100 \mu A$ )
- $I_D$  ----- 85 A
- $R_{DS(ON)}$  ----- 6.9 mΩ max. ( $V_{GS} = 10 V, I_D = 44.0 A$ )
- $Q_g$  ----- 42.9 nC ( $V_{GS} = 4.5 V, V_{DS} = 38 V, I_D = 44.0 A$ )
- Low Total Gate Charge
- High Speed Switching
- Low On-Resistance
- Capable of 4.5 V Gate Drive
- 100 % UIL Tested
- RoHS Compliant

**Package**

TO-263

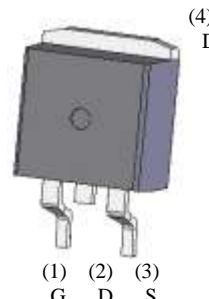

Not to scale

**Applications**

- DC-DC converters
- Synchronous Rectification
- Power Supplies

**Equivalent circuit**

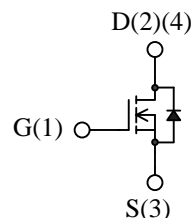

**Absolute Maximum Ratings**

● Unless otherwise specified,  $T_A = 25 \text{ }^\circ\text{C}$

Parameter	Symbol	Test conditions	Rating	Unit
Drain to Source Voltage	$V_{DS}$		75	V
Gate to Source Voltage	$V_{GS}$		$\pm 20$	V
Continuous Drain Current	$I_D$	$T_C = 25 \text{ }^\circ\text{C}$	85	A
Pulsed Drain Current	$I_{DM}$	$PW \leq 100 \mu s$ Duty cycle $\leq 1 \%$	170	A
Continuous Source Current (Body Diode)	$I_S$		85	A
Pulsed Source Current (Body Diode)	$I_{SM}$	$PW \leq 100 \mu s$ Duty cycle $\leq 1 \%$	170	A
Single Pulse Avalanche Energy	$E_{AS}$	$V_{DD} = 38 V, L = 1 mH,$ $I_{AS} = 13 A, \text{ unclamped,}$ $R_G = 4.7 \Omega,$ Refer to Figure 1	170	mJ
Avalanche Current	$I_{AS}$		30	A
Power Dissipation	$P_D$	$T_C = 25 \text{ }^\circ\text{C}$	135	W
Operating Junction Temperature	$T_J$		150	$^\circ\text{C}$
Storage Temperature Range	$T_{STG}$		- 55 to 150	$^\circ\text{C}$

**Thermal Characteristics**

• Unless otherwise specified,  $T_A = 25\text{ }^\circ\text{C}$

Parameter	Symbol	Test Conditions	Min.	Typ.	Max.	Unit
Thermal Resistance (Junction to Case)	$R_{\theta JC}$		–	–	0.9	$^\circ\text{C}/\text{W}$
Thermal Resistance (Junction to Ambient)	$R_{\theta JA}$		–	–	62.5	$^\circ\text{C}/\text{W}$

**Electrical Characteristics**

• Unless otherwise specified,  $T_A = 25\text{ }^\circ\text{C}$

Parameter	Symbol	Test Conditions	Min.	Typ.	Max.	Unit
Drain to Source Breakdown Voltage	$V_{(BR)DSS}$	$I_D = 100\text{ }\mu\text{A}$ , $V_{GS} = 0\text{ V}$	75	–	–	V
Drain to Source Leakage Current	$I_{DSS}$	$V_{DS} = 75\text{ V}$ , $V_{GS} = 0\text{ V}$	–	–	100	$\mu\text{A}$
Gate to Source Leakage Current	$I_{GSS}$	$V_{GS} = \pm 20\text{ V}$	–	–	$\pm 100$	nA
Gate Threshold Voltage	$V_{GS(th)}$	$V_{DS} = V_{GS}$ , $I_D = 1.5\text{ mA}$	1.0	2.0	2.5	V
Static Drain to Source On-Resistance	$R_{DS(on)}$	$I_D = 44.0\text{ A}$ , $V_{GS} = 10\text{ V}$	–	5.3	6.9	m $\Omega$
		$I_D = 22.0\text{ A}$ , $V_{GS} = 4.5\text{ V}$	–	6.0	7.6	m $\Omega$
Gate Resistance	$R_G$	$f = 1\text{ MHz}$	–	0.8	–	$\Omega$
Input Capacitance	$C_{iss}$	$V_{DS} = 25\text{ V}$ $V_{GS} = 0\text{ V}$ $f = 1\text{ MHz}$	–	6340	–	pF
Output Capacitance	$C_{oss}$		–	575	–	
Reverse Transfer Capacitance	$C_{rss}$		–	365	–	
Total Gate Charge ( $V_{GS} = 10\text{ V}$ )	$Q_{g1}$	$V_{DS} = 38\text{ V}$ $I_D = 44.0\text{ A}$	–	91.6	–	nC
Total Gate Charge ( $V_{GS} = 4.5\text{ V}$ )	$Q_{g2}$		–	42.9	–	
Gate to Source Charge	$Q_{gs}$		–	16.5	–	
Gate to Drain Charge	$Q_{gd}$		–	12.4	–	
Turn-On Delay Time	$t_{d(on)}$	$V_{DD} = 38\text{ V}$ $I_D = 44.0\text{ A}$ $V_{GS} = 10\text{ V}$ , $R_G = 4.7\text{ }\Omega$ Refer to Figure 2	–	10.7	–	ns
Rise Time	$t_r$		–	10.1	–	
Turn-Off Delay Time	$t_{d(off)}$		–	49.1	–	
Fall Time	$t_f$		–	21.0	–	
Source to Drain Diode Forward Voltage	$V_{SD}$	$I_S = 44.0\text{ A}$ , $V_{GS} = 0\text{ V}$	–	0.9	1.5	V
Source to Drain Diode Reverse Recovery Time	$t_{rr}$	$I_F = 44.0\text{ A}$ $di/dt = 100\text{ A}/\mu\text{s}$ Refer to Figure 3	–	48.4	–	ns
Source to Drain Diode Reverse Recovery Charge	$Q_{rr}$		–	75.7	–	nC

Test Circuits and Waveforms

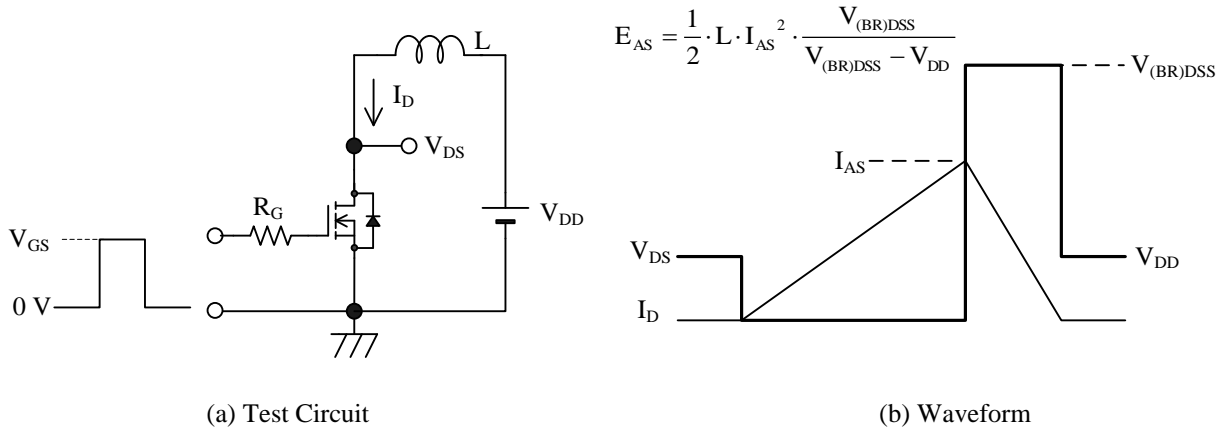

Figure 1 Unclamped Inductive Switching

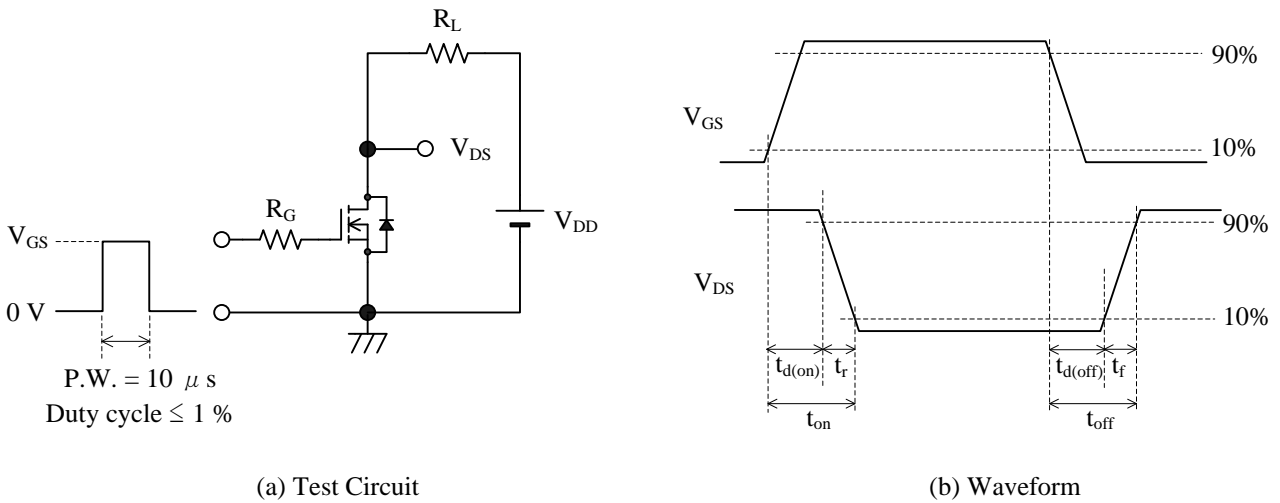

Figure 2 Switching Time

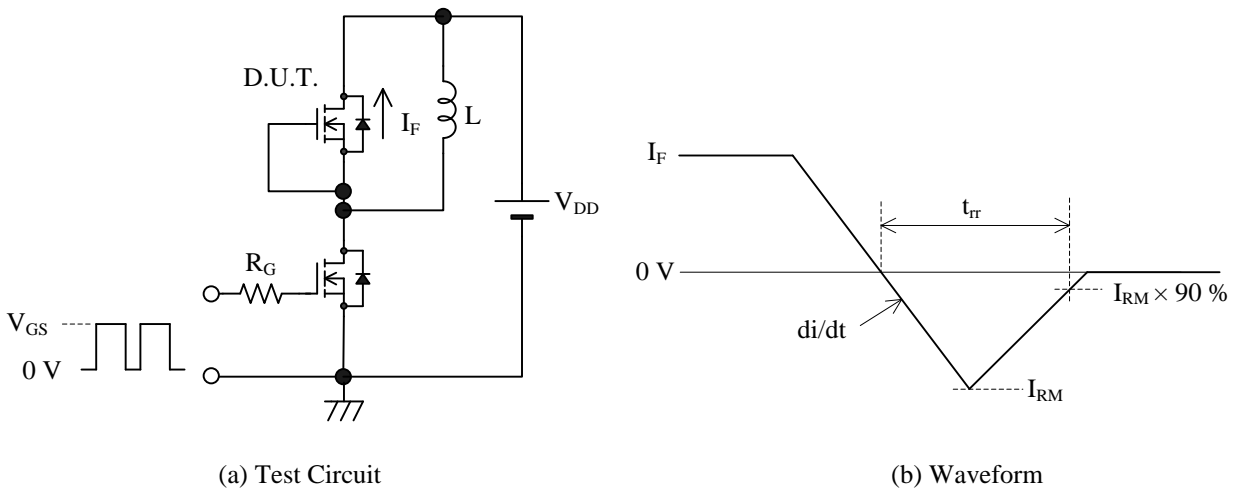
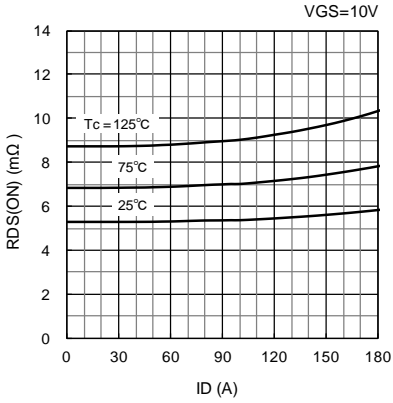
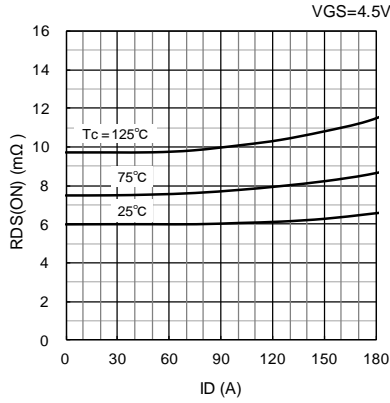

Figure 3 Diode Reverse Recovery Time

RDS(ON)-ID characteristics (typical)



RDS(ON)-ID characteristics (typical)



ID-VGS characteristics (typical)

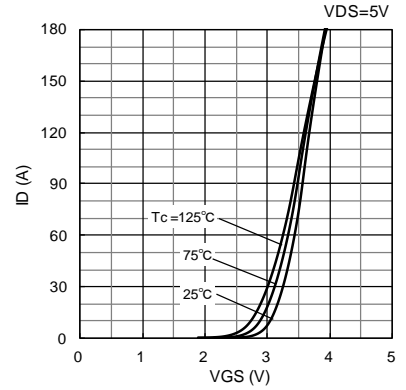

VDS-VGS characteristics (typical)

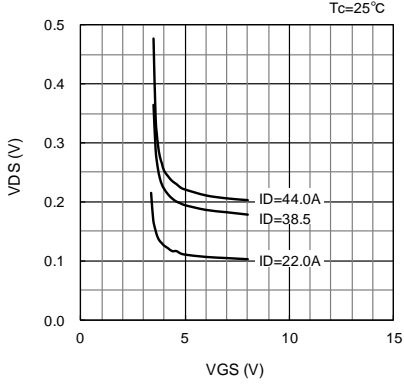

IDR-VSD characteristics (typical)

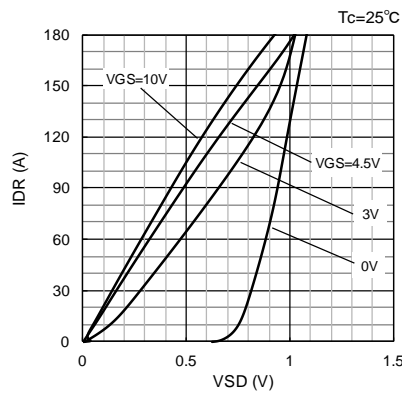

IDR-VSD characteristics (typical)

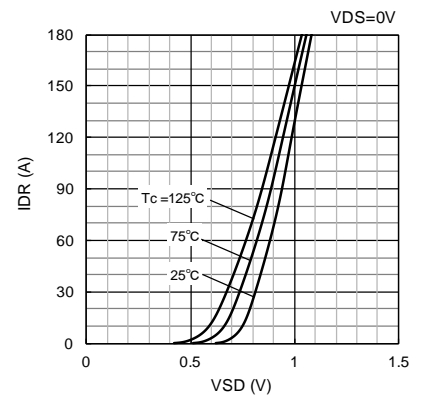

Capacitance-VDS characteristics (typical)

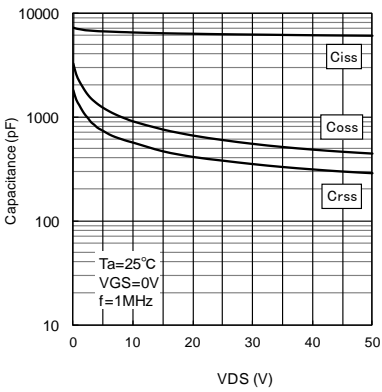

VGS - Qg characteristics (typical)

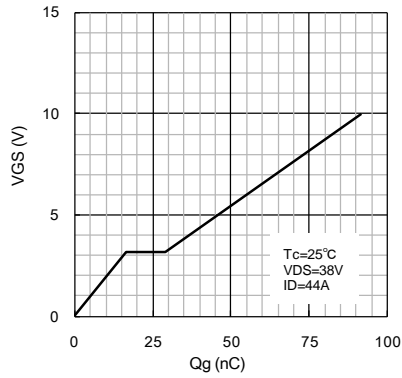

Vth-Tc characteristics (typical)

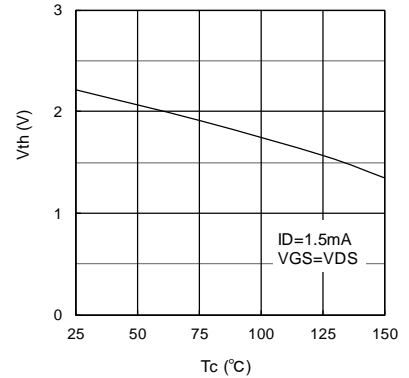

RDS(ON)-Tc characteristics (typical)

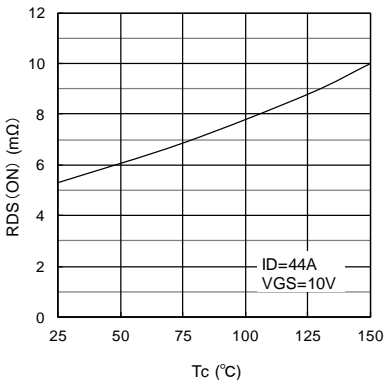

RDS(ON)-Tc characteristics (typical)

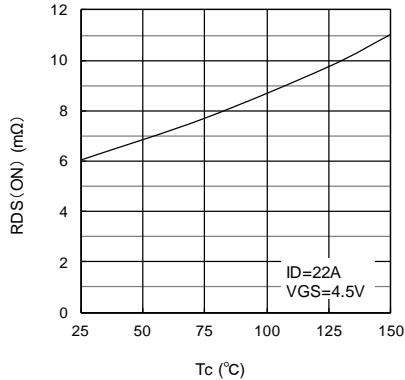

BVDSS-Tc characteristics (typical)

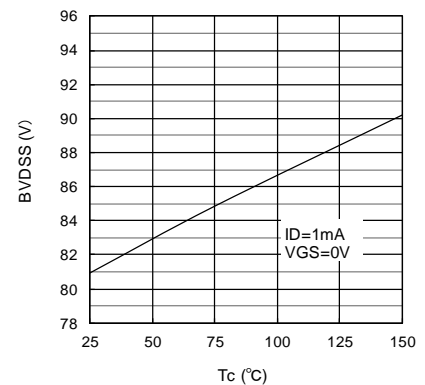

PD-Ta Derating

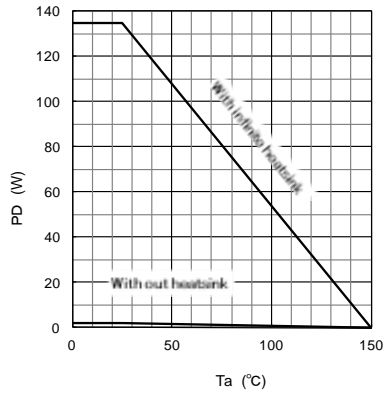

SAFE OPERATING AREA

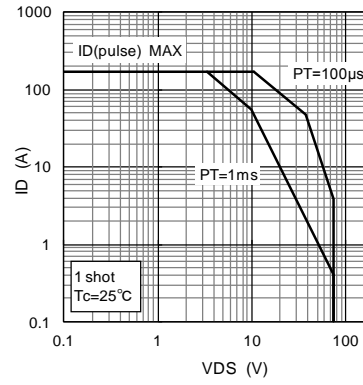

TRANSIENT THERMAL RESISTANCE - PULSE WIDTH

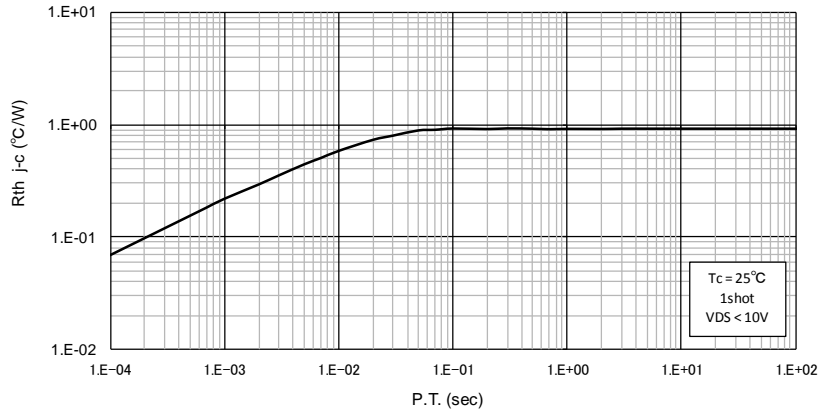

Package Outline  
TO-263

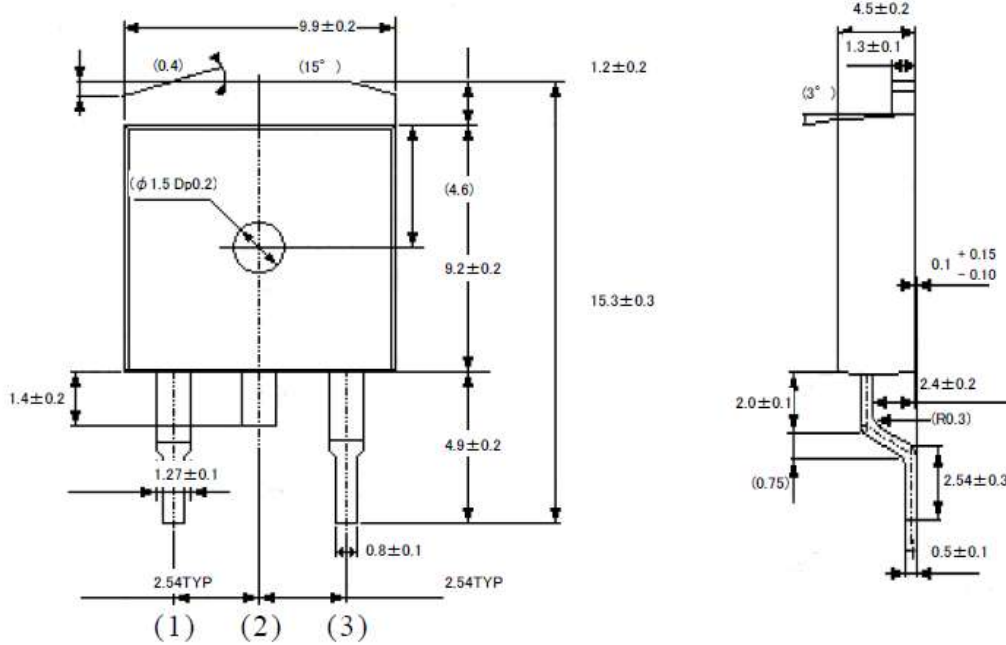

NOTES:

- 1) Dimension is in millimeters
- 2) Pb-free. Device composition compliant with the RoHS directive

Marking Diagram

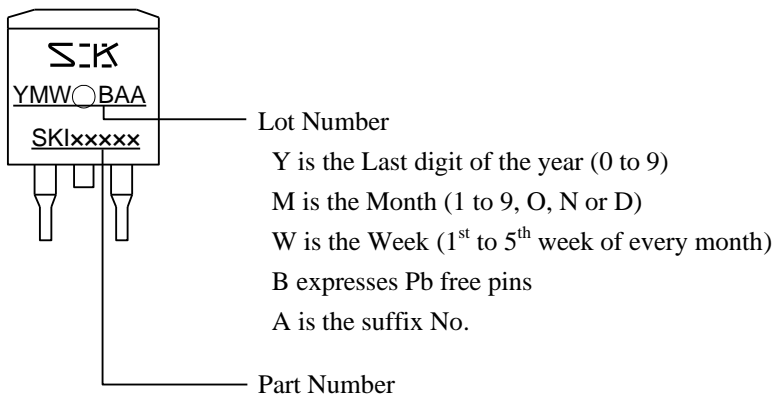

**OPERATING PRECAUTIONS**

In the case that you use Sanken products or design your products by using Sanken products, the reliability largely depends on the degree of derating to be made to the rated values. Derating may be interpreted as a case that an operation range is set by derating the load from each rated value or surge voltage or noise is considered for derating in order to assure or improve the reliability. In general, derating factors include electric stresses such as electric voltage, electric current, electric power etc., environmental stresses such as ambient temperature, humidity etc. and thermal stress caused due to self-heating of semiconductor products. For these stresses, instantaneous values, maximum values and minimum values must be taken into consideration. In addition, it should be noted that since power devices or IC's including power devices have large self-heating value, the degree of derating of junction temperature affects the reliability significantly.

Because reliability can be affected adversely by improper storage environments and handling methods, please observe the following cautions.

**Cautions for Storage**

- Ensure that storage conditions comply with the standard temperature (5 to 35°C) and the standard relative humidity (around 40 to 75%); avoid storage locations that experience extreme changes in temperature or humidity.
- Avoid locations where dust or harmful gases are present and avoid direct sunlight.
- Reinspect for rust on leads and solderability of the products that have been stored for a long time.

**Cautions for Testing and Handling**

When tests are carried out during inspection testing and other standard test periods, protect the products from power surges from the testing device, shorts between the product pins, and wrong connections. Ensure all test parameters are within the ratings specified by Sanken for the products.

**Remarks About Using Thermal Silicone Grease**

- When thermal silicone grease is used, it shall be applied evenly and thinly. If more silicone grease than required is applied, it may produce excess stress.
- The thermal silicone grease that has been stored for a long period of time may cause cracks of the greases, and it cause low radiation performance. In addition, the old grease may cause cracks in the resin mold when screwing the products to a heatsink.
- Fully consider preventing foreign materials from entering into the thermal silicone grease. When foreign material is immixed, radiation performance may be degraded or an insulation failure may occur due to a damaged insulating plate.
- The thermal silicone greases that are recommended for the resin molded semiconductor should be used. Our recommended thermal silicone grease is the following, and equivalent of these.

Type	Suppliers
G746	Shin-Etsu Chemical Co., Ltd.
YG6260	Momentive Performance Materials Japan LLC
SC102	Dow Corning Toray Co., Ltd.

**Soldering**

When soldering the products, please be sure to minimize the working time, within the following limits:

- Reflow      Preheat ; 180 °C / 90 ± 30 s  
                 Solder heating ; 250 °C / 10 ± 1s (260 °C peak, 2 times)
- Soldering iron ; 380 ± 10 °C / 3.5 ± 0.5s (1 time)

**Electrostatic Discharge**

- When handling the products, the operator must be grounded. Grounded wrist straps worn should have at least 1MΩ of resistance from the operator to ground to prevent shock hazard, and it should be placed near the operator.
- Workbenches where the products are handled should be grounded and be provided with conductive table and floor mats.
- When using measuring equipment such as a curve tracer, the equipment should be grounded.
- When soldering the products, the head of soldering irons or the solder bath must be grounded in order to prevent leak voltages generated by them from being applied to the products.
- The products should always be stored and transported in Sanken shipping containers or conductive containers, or be wrapped in aluminum foil.

## **IMPORTANT NOTES**

- The contents in this document are subject to changes, for improvement and other purposes, without notice. Make sure that this is the latest revision of the document before use.
- Application examples, operation examples and recommended examples described in this document are quoted for the sole purpose of reference for the use of the products herein and Sanken can assume no responsibility for any infringement of industrial property rights, intellectual property rights, life, body, property or any other rights of Sanken or any third party which may result from its use.
- Unless otherwise agreed in writing by Sanken, Sanken makes no warranties of any kind, whether express or implied, as to the products, including product merchantability, and fitness for a particular purpose and special environment, and the information, including its accuracy, usefulness, and reliability, included in this document.
- Although Sanken undertakes to enhance the quality and reliability of its products, the occurrence of failure and defect of semiconductor products at a certain rate is inevitable. Users of Sanken products are requested to take, at their own risk, preventative measures including safety design of the equipment or systems against any possible injury, death, fires or damages to the society due to device failure or malfunction.
- Sanken products listed in this document are designed and intended for the use as components in general purpose electronic equipment or apparatus (home appliances, office equipment, telecommunication equipment, measuring equipment, etc.).  
When considering the use of Sanken products in the applications where higher reliability is required (transportation equipment and its control systems, traffic signal control systems or equipment, fire/crime alarm systems, various safety devices, etc.), and whenever long life expectancy is required even in general purpose electronic equipment or apparatus, please contact your nearest Sanken sales representative to discuss, prior to the use of the products herein.  
The use of Sanken products without the written consent of Sanken in the applications where extremely high reliability is required (aerospace equipment, nuclear power control systems, life support systems, etc.) is strictly prohibited.
- When using the products specified herein by either (i) combining other products or materials therewith or (ii) physically, chemically or otherwise processing or treating the products, please duly consider all possible risks that may result from all such uses in advance and proceed therewith at your own responsibility.
- Anti radioactive ray design is not considered for the products listed herein.
- Sanken assumes no responsibility for any troubles, such as dropping products caused during transportation out of Sanken's distribution network.
- The contents in this document must not be transcribed or copied without Sanken's written consent.