

## NON-ISOLATED DC/DC CONVERTERS

8.3 Vdc - 14 Vdc Input

0.75 Vdc - 5.0 Vdc/6 A Output

Jan. 25, 2013

*Bel Power, Inc. , a subsidiary of Bel Fuse, Inc.*

**SRBA-06A1Ax**

**RoHS Compliant**

**Rev.C**

### Features

- Non-Isolated
- High Efficiency
- High Power Density
- Fixed Frequency
- Remote On/Off
- Certified to UL60950-1/CSA C22.2 No.60950-1, 2rd edition, am1
- Under-Voltage Lockout (UVLO)
- OCP/SCP
- Wide Input Range
- Wide Output Trim Range
- UL60950-1 Recognized (UL/cUL)

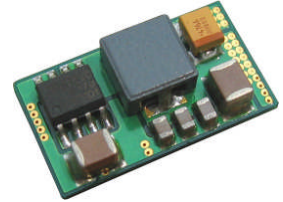

### Applications

- Networking
- Computers and peripherals
- Telecommunications

### Description

The Bel SRBA-06A1Ax modules are a series of non-isolated dc/dc converters that deliver up to 6 A of output current with full load efficiency of 92% at 5.0 Vdc output. These modules provide precisely regulated Voltage programmable via external resistor from 0.75 Vdc to 5.0 Vdc over a wide range of input voltage (8.3 Vdc - 14 Vdc). The open-frame construction and small footprint enable designers to develop cost and space-efficient solutions. Standard features include remote On/Off, over current protection, short current protection, wide input, and programmable output voltage.

### Part Selection

Output Voltage	Input Voltage	Max. Output Current	Max. Output Power	Typical Efficiency	Model Number Active Low	Model Number Active High
0.75 V - 5.0 V	8.3 V - 14 V	6 A	30.0 W	92%	SRBA-06A1AL	SRBA-06A1A0

**Notes:** 1.Add "G" suffix at the end of the model number to indicate Tray Packaging.

### Part Number Explanation

**S R BA - 06 A 1A x**  
**1 2 3 4 5 6 7**

1---Surface mount

2---RoHS 6, change "R" to "7" means RoHS 5

3---Series name

4---Series code

5---Wide input range (8.3-14V)

6---Wide trim

7---Option, "x" of the model part number to be 0-9, A-Z, which will represent the special request of customer.

# NON-ISOLATED DC/DC CONVERTERS

8.3 Vdc - 14 Vdc Input

0.75 Vdc - 5.0 Vdc/6 A Output



Jan. 25, 2013

Bel Power, Inc., a subsidiary of Bel Fuse, Inc.

## Absolute Maximum Ratings

Parameter	Min	Typ	Max	Notes
Input Voltage (continuous)	-0.3 V	-	15 V	
Output Enable Terminal Voltage	-0.3 V	-	15 V	
Ambient Temperature	-40 °C	-	85 °C	
Storage Temperature	-55 °C	-	125 °C	

## Input Specifications

Parameter	Min	Typ	Max	Notes
Input Voltage	8.3 V	12 V	14 V	
Input Current (full load)				
Vo=5.0 V	-	2.75 A	4.0 A	
Vo=3.3 V	-	1.85 A	2.8 A	
Vo=2.5 V	-	1.45 A	2.2 A	
Vo=1.8 V	-	1.05 A	1.6 A	
Vo=1.2 V	-	0.75 A	1.1 A	
Vo=0.75 V	-	0.55 A	0.8 A	
Input Current (no load)				
Vo=5.0 V	-	-	100 mA	
Vo=0.75 V	-	-	20 mA	
Remote Off Input Current	-	1 mA	2 mA	
Input Reflected Ripple Current (pk-pk)	-	120 mA	-	Tested with two 100 uF/25 V tantalum input capacitors & simulated source impedance of 1 uH, 5 Hz to 20 MHz.
Input Reflected Ripple Current (rms)	-	40 mA	-	
I <sup>2</sup> t Inrush Current Transient	-	0.002 A <sup>2</sup> s	0.02 A <sup>2</sup> s	
Turn-on Voltage Threshold	-	8.1 V	8.2 V	
Turn-off Voltage Threshold	-	7.5 V	8.0 V	

**Note:** All specifications are typical at 25 °C unless otherwise stated.

## Output Specifications

Parameter	Min	Typ	Max	Notes
Output Voltage Set Point	-2% Vo,set	-	2% Vo,set	Vin=12 V, full load
Output Voltage Set Point	-2.5% Vo,set	-	3.5% Vo,set	Over all operating input voltages, resistive loads and temperature conditions
Adjustment Range Selected by External Resistor or Voltage	0.7525 V	-	5.0 V	
Load Regulation	-	0.4% Vo,set	-	I <sub>o</sub> =I <sub>omin</sub> to I <sub>omax</sub>
Line Regulation	-	0.3% Vo,set	-	Vin= Vinmin to Vinmax
Regulation Over Temperature (-40 °C to +8 °C)	-	0.5% Vo,set	-	Tref=Tamin to Tamax
Output Current	0A	-	6A	
Current Limit Threshold	7.2A	-	18A	
Short Circuit Surge Transient	-	0.25A <sup>2</sup> s	-	
Ripple and Noise (pk-pk) Vo=0.75 V-3.63 V	-	50 mV	75 mV	Tested with 0-20MHz, with 10 uF/10 V tantalum capacitor & 1 uF/10 V TDK ceramic capacitor at the output.
Ripple and Noise (rms) Vo=0.75 V-3.63 V	-	15 mV	30 mV	
Ripple and Noise (pk-pk) Vo=5.0 V	-	75 mV	100 mV	
Ripple and Noise (rms) Vo=5.0 V	-	30 mV	40 mV	
Turn on Time	-	8 mS	10 mS	

# NON-ISOLATED DC/DC CONVERTERS

8.3 Vdc - 14 Vdc Input

0.75 Vdc - 5.0 Vdc/6 A Output



Jan. 25, 2013

Bel Power, Inc., a subsidiary of Bel Fuse, Inc.

## Output Specifications(continued)

Parameter	Min	Typ	Max	Notes
Overshoot at Turn on	-	0%	3%	
Output Capacitance				
ESR $\geq$ 1 mohm	0 uF	-	1000 uF	
ESR $\geq$ 10 mohm	0 uF	-	3300 uF	
<b>Transient Response</b>				
50% ~ 100% Max Load	-	200 mV	-	di/dt=2.5 A/uS; Vin=12 V; and With 10 uF/10 V tantalum capacitor & 1 uF/10 V ceramic capacitor at the output.
Settling Time	Vo = 0.75 V	50 uS	-	
100% ~ 50% Max Load	-5 V	200 mV	-	
Settling Time	-	50 uS	-	

**Note:** All specifications are typical at nominal input, full load at 25 °C unless other wise stated.

## General Specifications

Parameter	Min	Typ	Max	Notes
Efficiency				Measured at Vin=12 V, full load
Vo=5.0 V	90%	92%	-	
Vo=3.3 V	87%	89%	-	
Vo=2.5 V	85%	88%	-	
Vo=1.8 V	83%	86%	-	
Vo=1.2 V	79%	82%	-	
Vo=0.75 V	71%	74%	-	
Switching Frequency	250 kHz	300 kHz	350 kHz	
Over Temperature Shutdown	-	135 °C	-	
Output Trim Range (Wide trim)	0.7525 V	-	5 V	
MTBF	3,079,469 hours			Calculated Per Bell Core SR-332 (Io = Nominal; Ta = 25 °C)
Dimensions				
Inches (L x W x H)	0.8 x 0.45 x 0.251			
Millimeters (L x W x H)	20.32 x 11.42 x 6.38			
Weight	-	3 g	-	

**Note:** All specifications are typical at 25 °C unless other wise stated.

## Control Specifications

Parameter	Min	Typ	Max	Notes
<b>Remote On/Off</b>				
Signal Low (Unit Off)	-0.3 V	-	0.4 V	SRBA-06A1A0; Remote On/Off pin open, Unit on.
Signal High (Unit On)	2.5 V	-	14 V	
Signal Low (Unit On)	-0.3 V	-	0.4 V	SRBA-06A1AL; Remote On/Off pin open, Unit on.
Signal High (Unit Off)	2.5 V	-	14 V	

# NON-ISOLATED DC/DC CONVERTERS

8.3 Vdc - 14 Vdc Input

0.75 Vdc - 5.0 Vdc/6 A Output



Jan. 25, 2013

*Bel Power, Inc. , a subsidiary of Bel Fuse, Inc.*

## Remote Enable Specifications

The SRBA-06A1AL modules feature an enable pin with negative logic. If not using the enable pin, leave the pin open (the module will be on). During logic\_high, the module is turned off, during logic\_low, the module is turned on. Its inner circuit impedance is shown as figure.

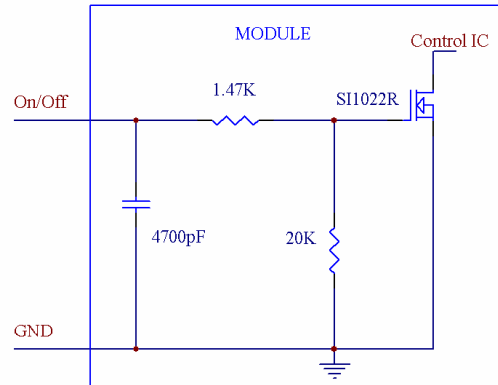

SRBA-06A1AL

The SRBA-06A1A0 modules feature an enable pin with Positive logic. If not using the enable pin, leave the pin open (the module will be on). During logic\_high, the module is turned on, during logic\_low, the module is turned off. Its inner circuit impedance is shown as figure.

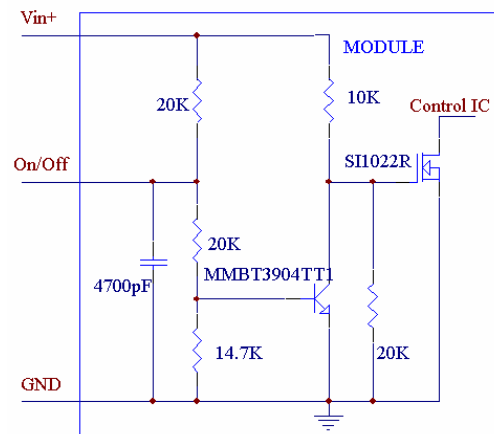

SRBA-06A1A0

## NON-ISOLATED DC/DC CONVERTERS

8.3 Vdc - 14 Vdc Input

0.75 Vdc - 5.0 Vdc/6 A Output

**bel**

Jan. 25, 2013

*Bel Power, Inc. , a subsidiary of Bel Fuse, Inc.*

### Output Trim Equations

Equation for calculating the trim resistor (in k $\Omega$ ) given the desired adjusted voltage ( $V_{adj}$ ) is shown below. The Trim Up resistor should be connected between the Trim pin and Ground.

$$R_{trim} = \frac{10.507}{V_{adj} - 0.7525} - 1$$

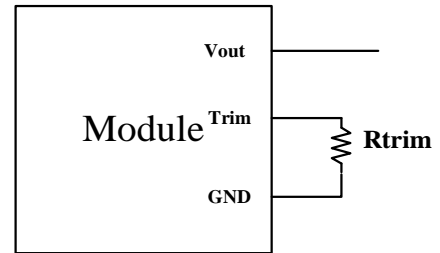

Equation for calculating the trim voltage (in V) given the desired adjusted voltage ( $V_{adj}$ ) is shown below. The Trim Up voltage should be connected between the Trim pin and Ground.

$$V_{trim} = 0.7 - 0.0667 \times (V_{adj} - 0.7525)$$

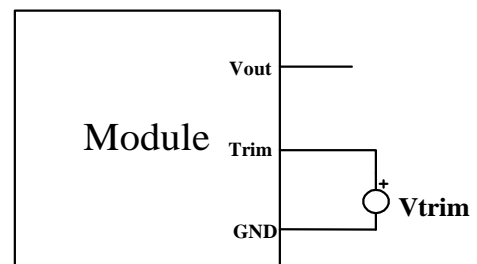

# NON-ISOLATED DC/DC CONVERTERS

8.3 Vdc - 14 Vdc Input

0.75 Vdc - 5.0 Vdc/6 A Output



Jan. 25, 2013

Bel Power, Inc., a subsidiary of Bel Fuse, Inc.

## Efficiency Data

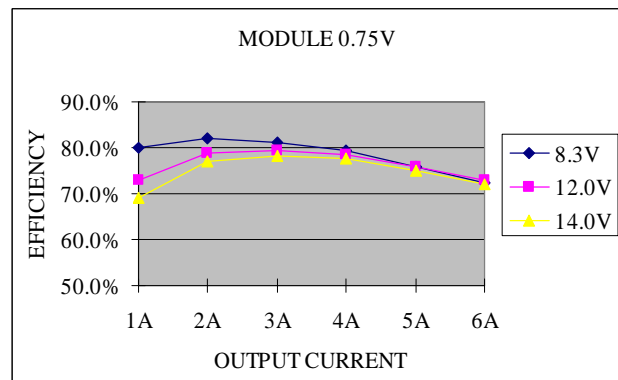
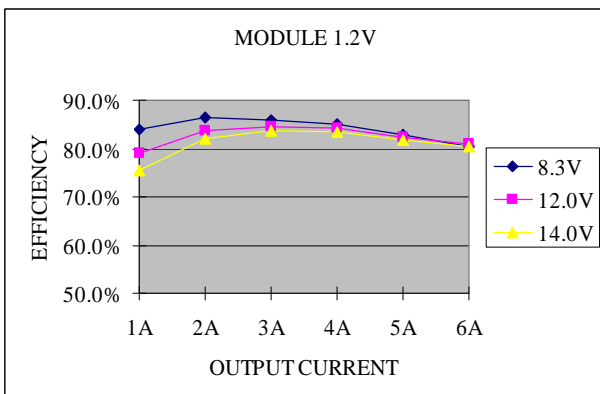
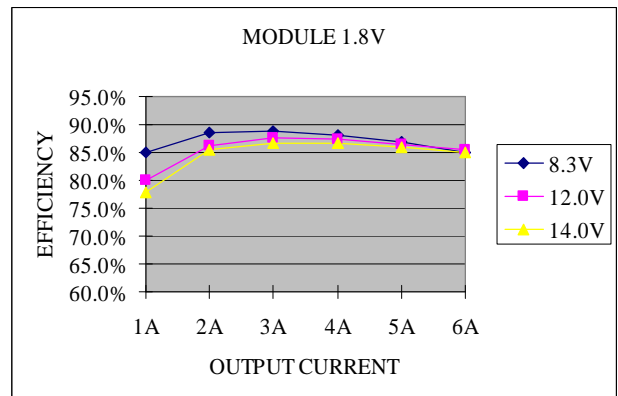
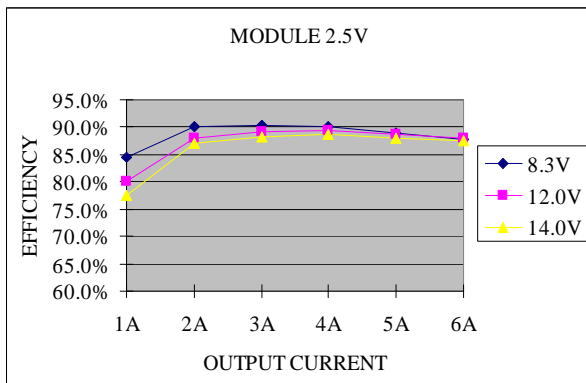
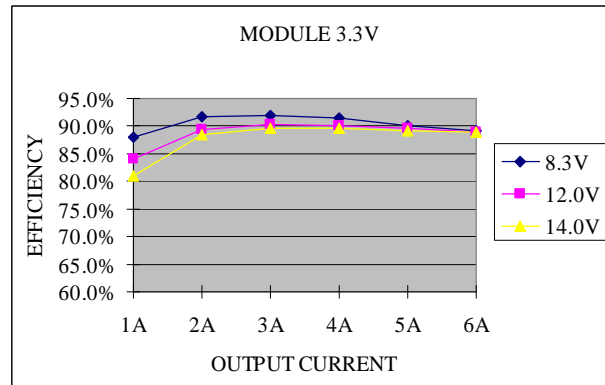
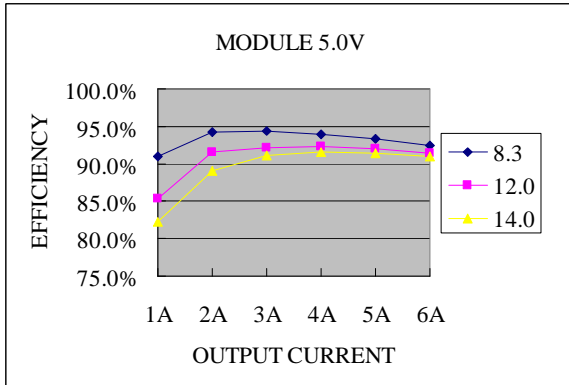

# NON-ISOLATED DC/DC CONVERTERS

8.3 Vdc - 14 Vdc Input

0.75 Vdc - 5.0 Vdc/6 A Output



Jan. 25, 2013

*Bel Power, Inc., a subsidiary of Bel Fuse, Inc.*

## Thermal Derating Curves

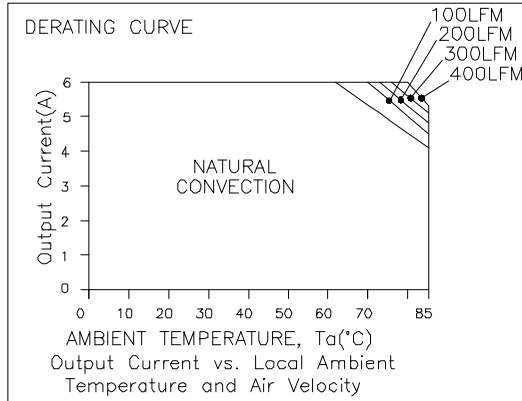

Vin=12 V, Vo=0.75 V

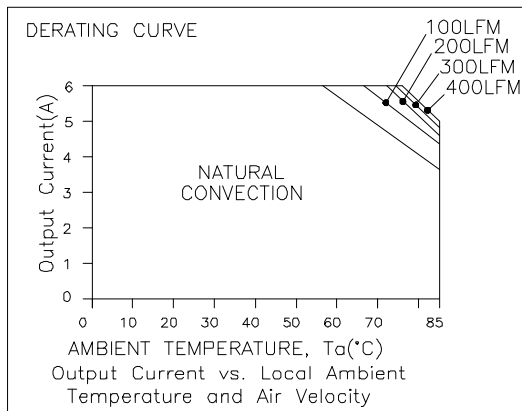

Vin=12 V, Vo=2.5 V

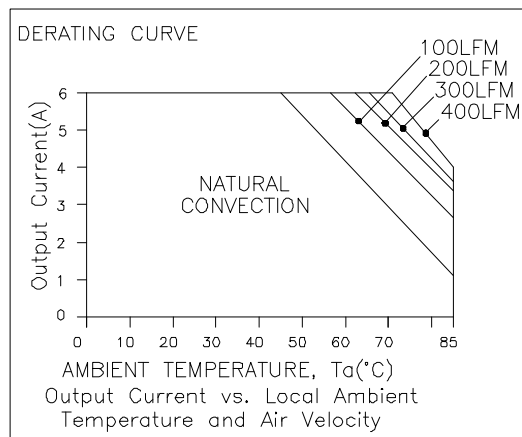

Vin=12 V, Vo=5.0 V

# NON-ISOLATED DC/DC CONVERTERS

8.3 Vdc - 14 Vdc Input

0.75 Vdc - 5.0 Vdc/6 A Output



Jan. 25, 2013

Bel Power, Inc., a subsidiary of Bel Fuse, Inc.

## Ripple and Noise Waveforms

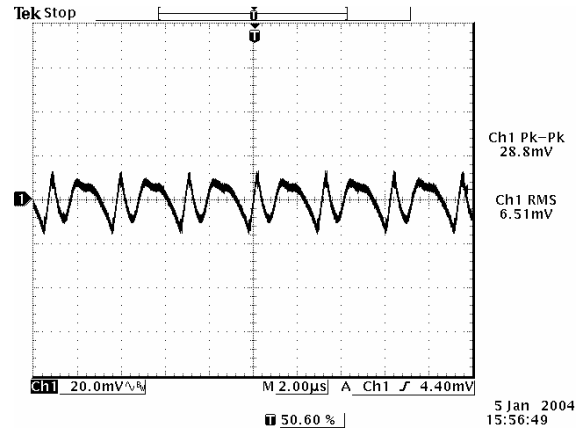
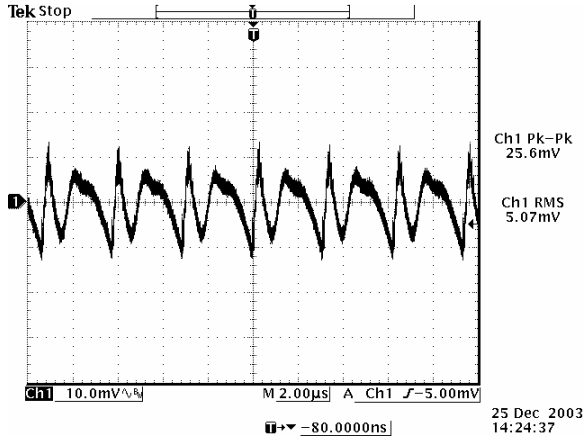

Ripple and noise at full load,  $V_{in}=12\text{ V}$ ,  $V_o=0.75\text{ V}$

Ripple and noise at full load,  $V_{in}=12\text{ V}$ ,  $V_o=1.2\text{ V}$

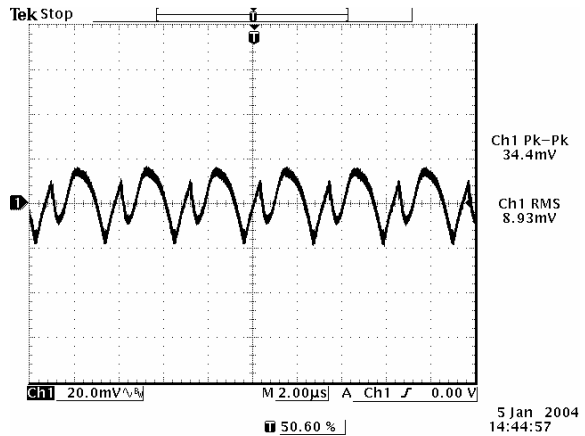
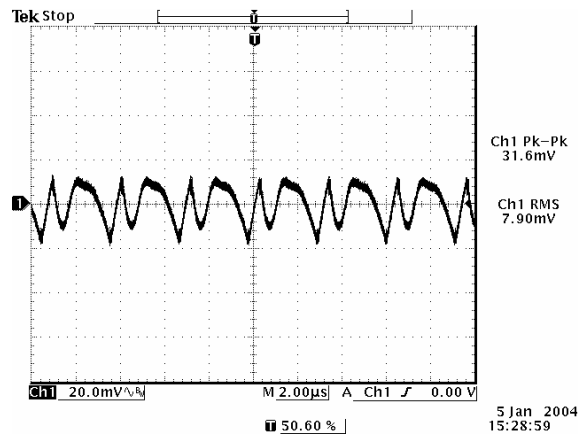

Ripple and noise at full load,  $V_{in}=12\text{ V}$ ,  $V_o=1.8\text{ V}$

Ripple and noise at full load,  $V_{in}=12\text{ V}$ ,  $V_o=2.5\text{ V}$

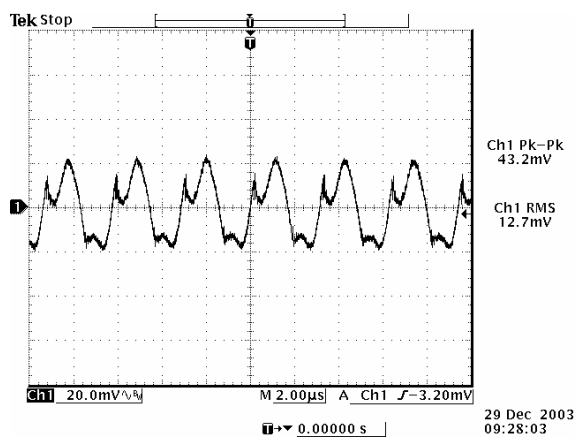
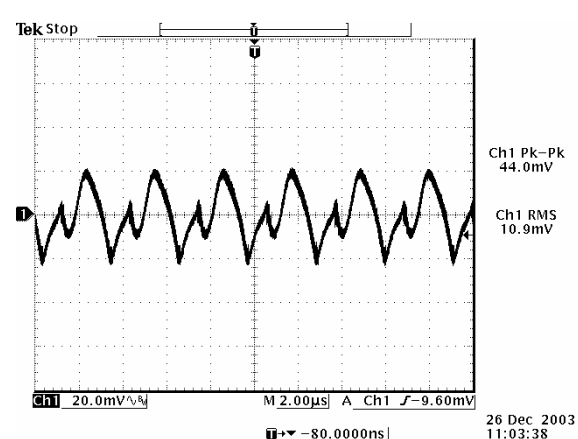

Ripple and noise at full load,  $V_{in}=12\text{ V}$ ,  $V_o=3.3\text{ V}$

Ripple and noise at full load,  $V_{in}=12\text{ V}$ ,  $V_o=5.0\text{ V}$

**Note:** The output ripple and noise is tested at 0-20 MHz BW, 10  $\mu\text{F}/10\text{ V}$  tantalum capacitor and 1  $\mu\text{F}/10\text{ V}$  ceramic capacitor,  $T_a=25\text{ deg C}$ .



# NON-ISOLATED DC/DC CONVERTERS

8.3 Vdc - 14 Vdc Input

0.75 Vdc - 5.0 Vdc/6 A Output



Jan. 25, 2013

Bel Power, Inc., a subsidiary of Bel Fuse, Inc.

## Transient Response Waveforms

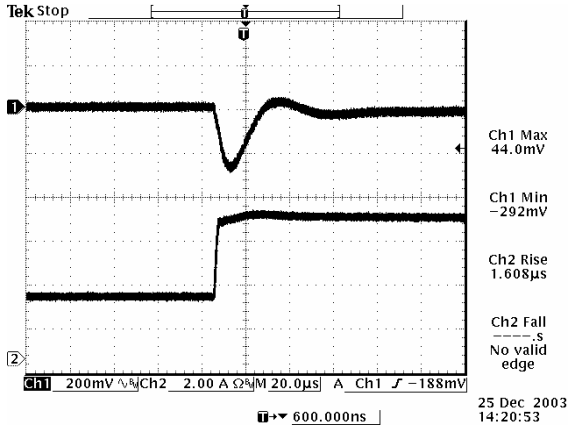

50% to 100% load step at  $V_{in}=12\text{ V}$ ,  $V_o=0.75\text{ V}$

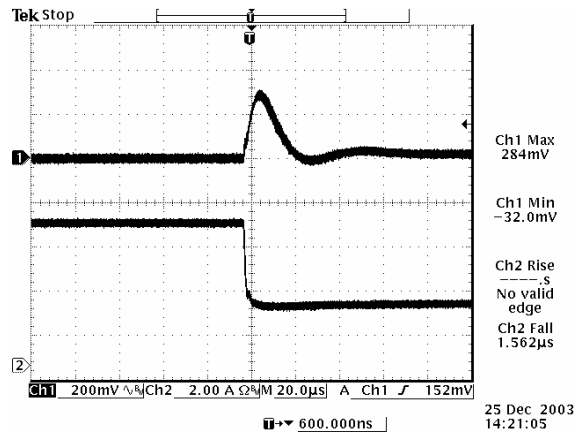

100% to 50% load step at  $V_{in}=12\text{ V}$ ,  $V_o=0.75\text{ V}$

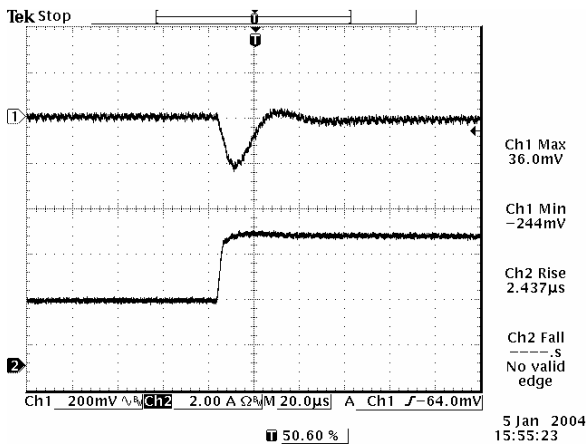

50% to 100% load step at  $V_{in}=12\text{ V}$ ,  $V_o=1.2\text{ V}$

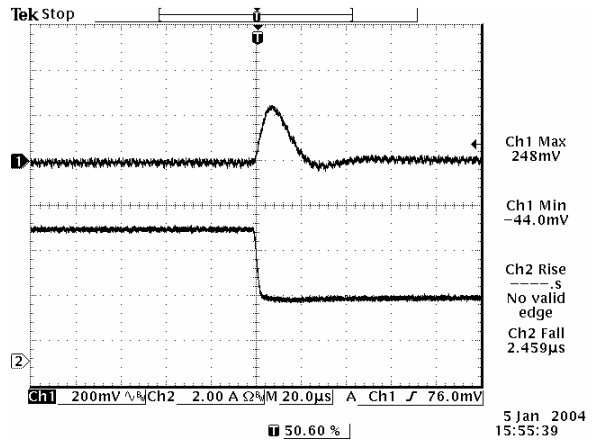

100% to 50% load step at  $V_{in}=12\text{ V}$ ,  $V_o=1.2\text{ V}$

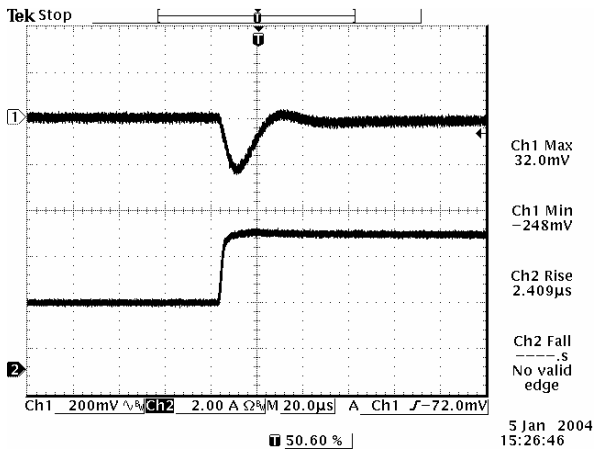

50% to 100% load step at  $V_{in}=12\text{ V}$ ,  $V_o=1.8\text{ V}$

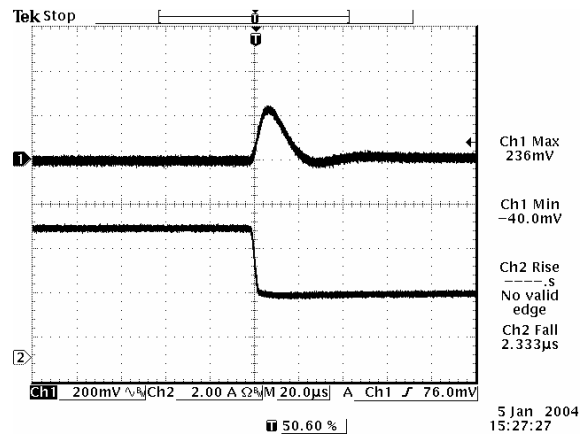

100% to 50% load step at  $V_{in}=12\text{ V}$ ,  $V_o=1.8\text{ V}$

# NON-ISOLATED DC/DC CONVERTERS

8.3 Vdc - 14 Vdc Input

0.75 Vdc - 5.0 Vdc/6 A Output



Jan. 25, 2013

Bel Power, Inc., a subsidiary of Bel Fuse, Inc.

## Transient Response Waveforms (continued)

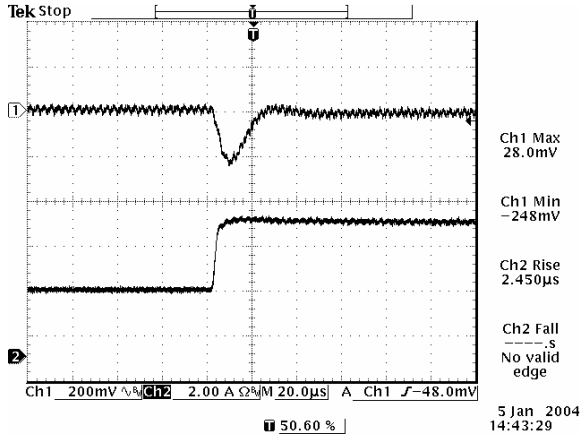

50% to 100% load step at  $V_{in}=12\text{ V}$ ,  $V_o=2.5\text{ V}$

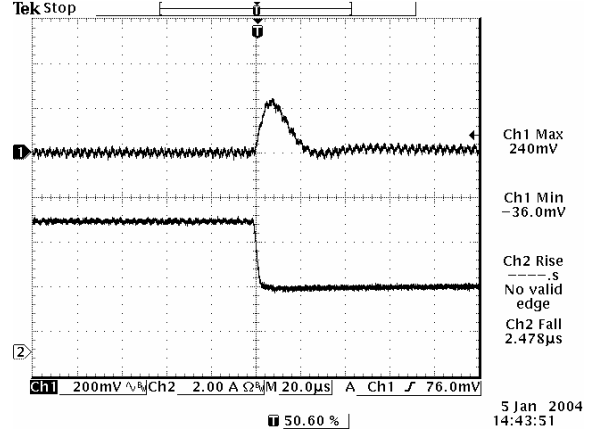

100% to 50% load step at  $V_{in}=12\text{ V}$ ,  $V_o=2.5\text{ V}$

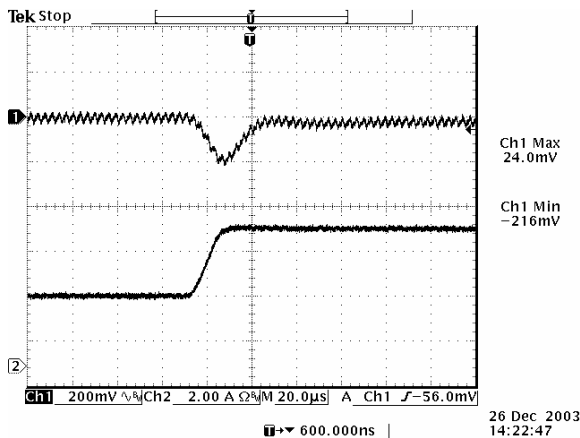

50% to 100% load step at  $V_{in}=12\text{ V}$ ,  $V_o=3.3\text{ V}$

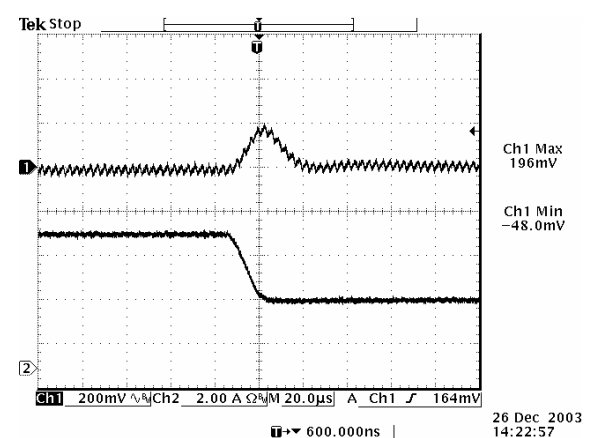

100% to 50% load step at  $V_{in}=12\text{ V}$ ,  $V_o=3.3\text{ V}$

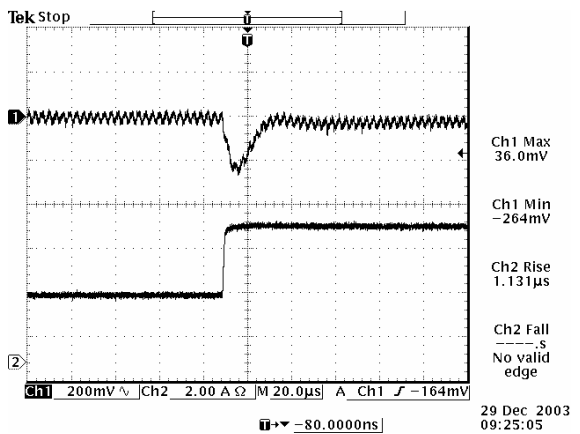

50% to 100% load step at  $V_{in}=12\text{ V}$ ,  $V_o=5.0\text{ V}$

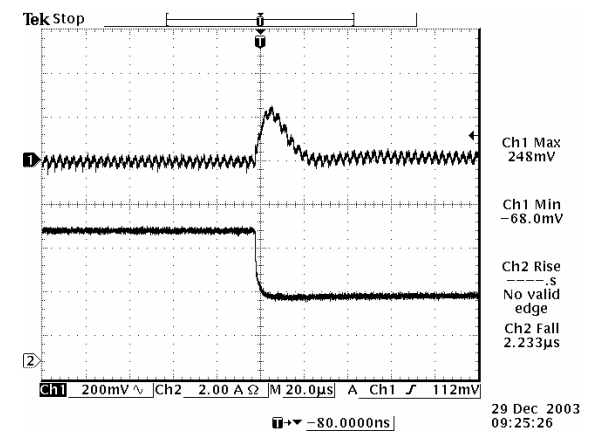

100% to 50% load step at  $V_{in}=12\text{ V}$ ,  $V_o=5.0\text{ V}$

**Note:** Transient response is tested at  $di/dt=2.5\text{ A}/\mu\text{S}$ , with 10  $\mu\text{F}/10\text{ V}$  tantalum capacitor and 1  $\mu\text{F}/10\text{ V}$  ceramic capacitor,  $T_a=25\text{ deg C}$ .

# NON-ISOLATED DC/DC CONVERTERS

8.3 Vdc - 14 Vdc Input

0.75 Vdc - 5.0 Vdc/6 A Output



Jan. 25, 2013

Bel Power, Inc., a subsidiary of Bel Fuse, Inc.

## Mechanical Outline

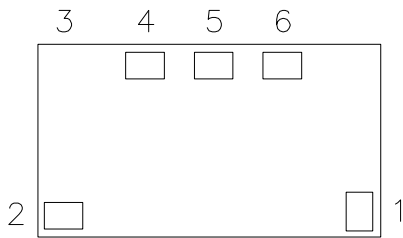
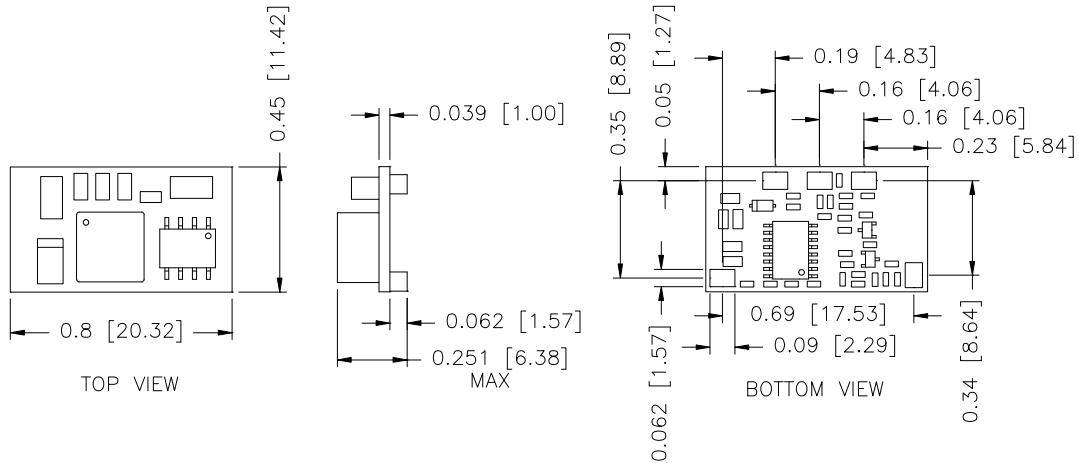

### Pin Connections

Pin	Function
1	Remote On/Off
2	Vin+
3	No Pin
4	Ground
5	Trim
6	Vout+

### RECOMMENDED PAD LAYOUT

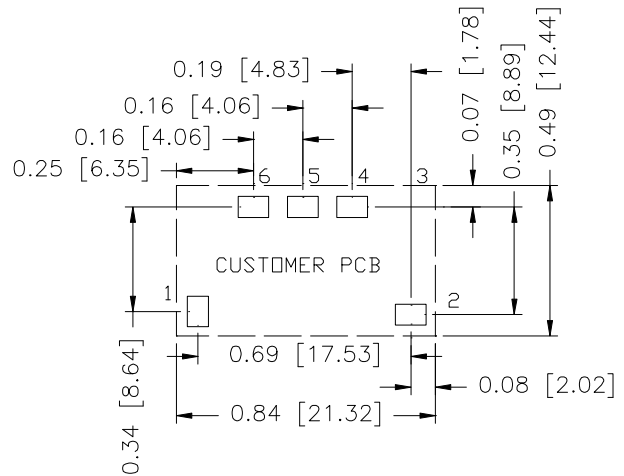

#### PAD SIZE:

MIN: 0.12" \* 0.095" (3.05mm \* 2.41mm)

MAX: 0.135" \* 0.11" (3.43mm \* 2.79mm)

**Note:** These parts are not however compatible with the higher temperatures associated with lead free solder processes and must be soldered using a reflow profile with a peak temperature of no more than 245 °C.

#### Note:

- 1) All Pins: Material - Copper Alloy;  
Finish – 3 micro inches minimum Gold over 50 micro inches minimum Nickel plate.
- 2) Undimensioned components are shown for visual reference only.
- 3) All dimensions in inches (mm); Tolerances: x.xx +/-0.02 in. (x.x +/-0.5mm) x.xxx +/-0.010 in. (x.xx +/-0.25mm).

## NON-ISOLATED DC/DC CONVERTERS

8.3 Vdc - 14 Vdc Input

0.75 Vdc - 5.0 Vdc/6 A Output



Jan. 25, 2013

*Bel Power, Inc. , a subsidiary of Bel Fuse, Inc.*

### Revision History

Date	Revision	Changes Detail	Approval
2007-01-12	A	Change version to A	Lynn
2011-08-25	B	Update the reflow solder temperature.	HL
2013-01-25	C	Update UL.	HL

### RoHS Compliance

Complies with the European Directive 2002/95/EC, calling for the elimination of lead and other hazardous substances from electronic products. These parts are not however compatible with the higher temperatures associated with lead free solder processes and must be soldered using a reflow profile with a peak temperature of no more than 240°C



©2013 Bel Fuse Inc. Specifications subject to change without notice. 012513

#### CORPORATE

**Bel Fuse Inc.**  
206 Van Vorst Street  
Jersey City, NJ 07302  
Tel 201-432-0463  
Fax 201-432-9542  
[WWW.belfuse.com](http://WWW.belfuse.com)

#### FAR EAST

**Bel Fuse Ltd.**  
8F/ 8 Luk Hop Street  
San Po Kong  
Kowloon, Hong Kong  
Tel 852-2328-5515  
Fax 852-2352-3706  
[WWW.belfuse.com](http://WWW.belfuse.com)

#### EUROPE

**Bel Fuse Europe Ltd.**  
Preston Technology Management Centre  
Marsh Lane, Suite G7, Preston  
Lancashire, PR1 8UD, U.K.  
Tel 44-1772-556601  
Fax 44-1772-888366  
[WWW.belfuse.com](http://WWW.belfuse.com)