

Installing and using Nanoline controllers

User manual
UM EN NLC

User manual

Installing and using Nanoline controllers

2015-07-15

Designation: UM EN NLC

Revision: O

This user manual is valid for:

Designation	Version	Order No.
Nanoline		

Please observe the following notes

User group of this manual

The use of products described in this manual is oriented exclusively to:

- Qualified electricians or persons instructed by them, who are familiar with applicable standards and other regulations regarding electrical engineering and, in particular, the relevant safety concepts.
- Qualified application programmers and software engineers, who are familiar with the safety concepts of automation technology and applicable standards.

Explanation of symbols used and signal words



This is the safety alert symbol. It is used to alert you to potential personal injury hazards. Obey all safety measures that follow this symbol to avoid possible injury or death.

There are three different categories of personal injury that are indicated with a signal word.

DANGER This indicates a hazardous situation which, if not avoided, will result in death or serious injury.

WARNING This indicates a hazardous situation which, if not avoided, could result in death or serious injury.

CAUTION This indicates a hazardous situation which, if not avoided, could result in minor or moderate injury.



This symbol together with the signal word **NOTE** and the accompanying text alert the reader to a situation which may cause damage or malfunction to the device, hardware/software, or surrounding property.



This symbol and the accompanying text provide the reader with additional information or refer to detailed sources of information.

How to contact us

Internet

Up-to-date information on Phoenix Contact products and our Terms and Conditions can be found on the Internet at:

phoenixcontact.com

Make sure you always use the latest documentation.

It can be downloaded at:

phoenixcontact.net/products

Subsidiaries

If there are any problems that cannot be solved using the documentation, please contact your Phoenix Contact subsidiary.

Subsidiary contact information is available at phoenixcontact.com.

Published by

PHOENIX CONTACT GmbH & Co. KG
Flachsmarktstraße 8
32825 Blomberg
GERMANY

Should you have any suggestions or recommendations for improvement of the contents and layout of our manuals, please send your comments to:

tecdoc@phoenixcontact.com

Please observe the following notes

General terms and conditions of use for technical documentation

Phoenix Contact reserves the right to alter, correct, and/or improve the technical documentation and the products described in the technical documentation at its own discretion and without giving prior notice, insofar as this is reasonable for the user. The same applies to any technical changes that serve the purpose of technical progress.

The receipt of technical documentation (in particular user documentation) does not constitute any further duty on the part of Phoenix Contact to furnish information on modifications to products and/or technical documentation. You are responsible to verify the suitability and intended use of the products in your specific application, in particular with regard to observing the applicable standards and regulations. All information made available in the technical data is supplied without any accompanying guarantee, whether expressly mentioned, implied or tacitly assumed.

In general, the provisions of the current standard Terms and Conditions of Phoenix Contact apply exclusively, in particular as concerns any warranty liability.

This manual, including all illustrations contained herein, is copyright protected. Any changes to the contents or the publication of extracts of this document is prohibited.

Phoenix Contact reserves the right to register its own intellectual property rights for the product identifications of Phoenix Contact products that are used here. Registration of such intellectual property rights by third parties is prohibited.

Other product identifications may be afforded legal protection, even where they may not be indicated as such.

Table of contents

1	Overview.....	5
1.1	Components.....	5
1.1.1	Nanoline base unit	6
1.1.2	I/O expansion modules	6
1.1.3	Communication expansion modules	7
1.1.4	Option module	7
1.2	Operator Panel	8
1.2.1	NLC-OP1-LCD-032-4X20	8
1.2.2	NLC-OP2-LCD-076-4X20	9
1.3	nanoNavigator programming software.....	10
2	Installation and connection of Nanoline components.....	11
2.1	Base and expansion module installation.....	11
2.1.1	Installing modules on the mounting rail	11
2.1.2	Removing modules from the mounting rail	13
2.2	Option modules	14
2.2.1	RS-232 connections	16
2.2.2	RS-485 connections	16
2.2.3	Modbus network connection (NLC-03... only)	17
2.2.4	USB connections	18
2.3	Operator Panel	18
2.3.1	Local installation	19
2.3.2	Remote installation	19
2.4	Connecting power, inputs and outputs	24
2.4.1	Power	25
2.4.2	Digital inputs	26
2.4.3	Digital outputs	27
2.4.4	Analog inputs	28
2.4.5	Analog outputs	28
2.4.6	Relay outputs	29
2.4.7	Temperature inputs	32
2.5	LED indicators	33
2.5.1	Base unit	33
3	Communication.....	35
3.1	Serial connections.....	35
3.1.1	RS-232	36
3.1.2	RS-485	37
3.1.3	USB	37
3.1.4	Memory Module	37
3.2	Ethernet communication.....	39
3.2.1	LEDs	40
3.2.2	Communications watchdog	40

3.3	Cellular communication	40
3.4	Modbus communication	41
3.4.1	ModScan32	41
3.5	Nanoline to Nanoline communication	45
3.5.1	Connection	45
3.5.2	Configuration	46
3.6	Real-time clock	47
3.6.1	RTC faults	49
4	Commissioning	51
4.1	Introduction.....	51
4.1.1	Installation checks	52
4.1.2	Field wiring checks	53
4.1.3	Power up and functionality checks	55
4.1.4	Field equipment commissioning	56
5	Operator Panel usage	63
5.1	Description	63
5.2	Key usage for NLC-OP1-LCD-032-4X20	63
5.2.1	Special key combinations	64
5.3	Key usage for NLC-OP2-LCD-076-4X20	65
5.3.1	Special key combinations	65
5.4	Run mode	67
5.4.1	Project loaded and message sent	67
5.4.2	Project loaded and no message sent	67
5.4.3	No project loaded	68
5.5	Monitor mode	69
5.6	System menu.....	70
5.6.1	Monitor Data Items	70
5.6.2	Run/Stop menu	78
5.6.3	Password	79
5.6.4	Project name	79
5.6.5	Setup	80
5.6.6	Memory module	81
A	Technical appendix.....	83
A 1	Modbus® holding registers	83
A 2	Modbus/Nanoline communication	86
A 2.1	NLC-050... Modbus map	87
A 2.2	NLC-055... Modbus map	88
A 3	Special formats.....	89

B	Technical appendix – Status/command flags.....	91
	B 1 NLC-050... flags.....	91
	B 2 NLC-055... flags.....	94
C	Technical appendix – Commissioning	97
	C 1 Hot-swappable modules.....	97
	C 2 Commissioning checklist.....	98
	C 3 Points chart.....	100
D	Technical Appendix – Technical data	103
	D 1 Ordering data	103
	D 2 Technical specifications	105
	D 2.1 NLC-050... base unit	105
	D 2.2 NLC-055... base unit	107
	D 2.3 NLC-035... and NLC-040 base units	109
	D 2.4 Digital I/O expansion module	111
	D 2.5 Analog expansion module (Order No. 2701098)	113
	D 2.6 Analog expansion module (Order No. 2701040)	114
	D 2.7 Temperature expansion module (Order No. 2701671)	115
	D 2.8 Operator Panel (Order No. 2701137)	116
	D 2.9 Operator Panel (Order No. 2701945)	117
	D 2.10 Ethernet module (Order No. 2701124)	117
	D 2.11 GSM modem module (Order No. 2701344)	118
	D 2.12 CDMA modem module (Order No. 2400428)	119
	D 2.13 Base unit option module	120
	D 2.14 RTC technical specifications (Order No. 2701153)	120
	D 3 Conformance/approvals	121
E	Appendixes.....	123
	E 1 List of figures	123
	E 2 List of tables	127
	E 3 Index.....	129

1 Overview

The Nanoline family is a cost-effective programmable logic controller (PLC) that allows purchase of only the components and capabilities required for a specific application. This flexibility is achieved by using a modular approach to build a control system using a base unit and adding various expansion and option modules.

1.1 Components

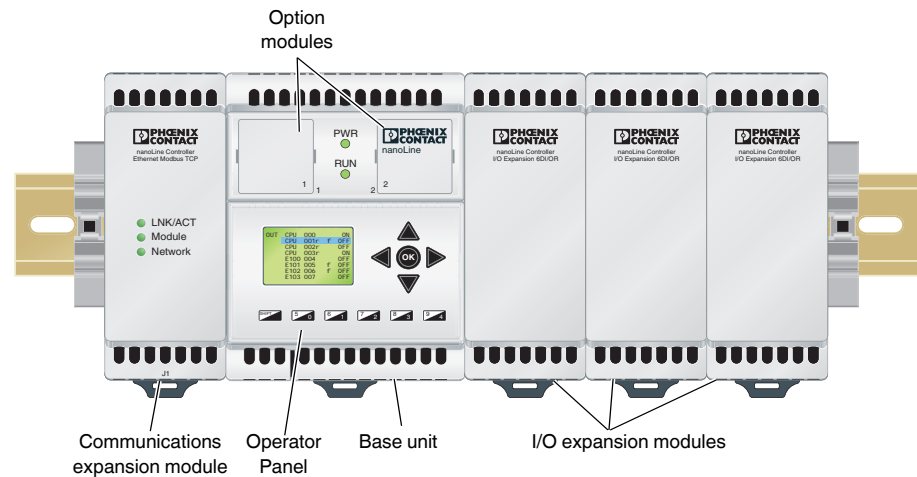

Figure 1-1 Typical system module layout

Starting with a base unit (NLC-05x-...), various expansion modules are connected to create the desired control system. The items that can be connected to the base unit are:

- I/O expansion modules
- Communication expansion modules
- Operator Panel
- Option modules

The base unit, communication expansion modules and I/O expansion modules attach to standard NS 35 mounting rail.

The type code on each base unit indicates how the base unit is equipped. See Figure 1-2 for an explanation of the type codes.

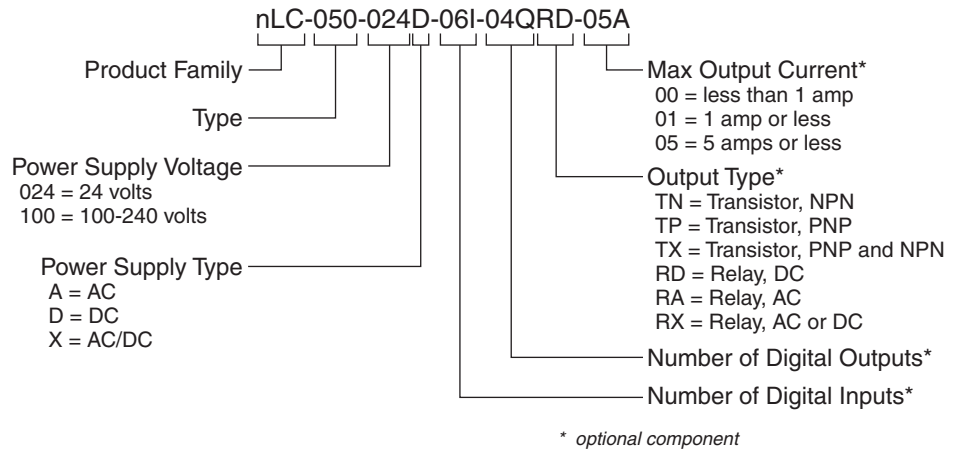

Figure 1-2 Nanoline base unit type codes

1.1.1 Nanoline base unit

The base unit contains the processing capability of the Nanoline system. One base unit is required for each Nanoline control system. Power connections are made to the base unit and distributed to the various modules from the base unit. The base unit also contains connection points (terminals) for the input and output devices that are controlled or monitored.

NLC-05...

A maximum of three I/O expansion modules can be attached to a base unit.

Two option slots are available on the base unit to install base unit option modules. D-SUB 9 connectors are located on each side of the unit. The left-side connector is for communication expansion modules, and the right-side connector is for I/O expansion modules. Both connectors are female to prevent improper module connection.

The power requirements and input/output (I/O) mix determine the model of base unit used.

NLC-03...

The NLC-03... base unit has an integrated RJ12 connector as a connection point for programming, RS-232 or RS-485 2-wire communication. D-SUB 9 connectors are located on each side of the base unit. The left-side connector is for communication modules and the right-side connector allows connection of one NLC-IOX... expansion module.

1.1.2 I/O expansion modules

In addition to the I/O points located on the base unit, I/O expansion modules (NLC-IO-...) can be connected to the base unit to provide additional connection points. Different I/O modules provide different combinations and types of I/O.

I/O expansion modules are always connected on the right side of the base unit. For example, a PNP or analog I/O expansion module can be added to an NPN base unit. A female D-SUB 9 connector located on the left side of the module connects to a male D-SUB 9 connector on the right side of the base unit or previously installed I/O expansion module. A maximum of three NLC-IO-... modules can be connected.

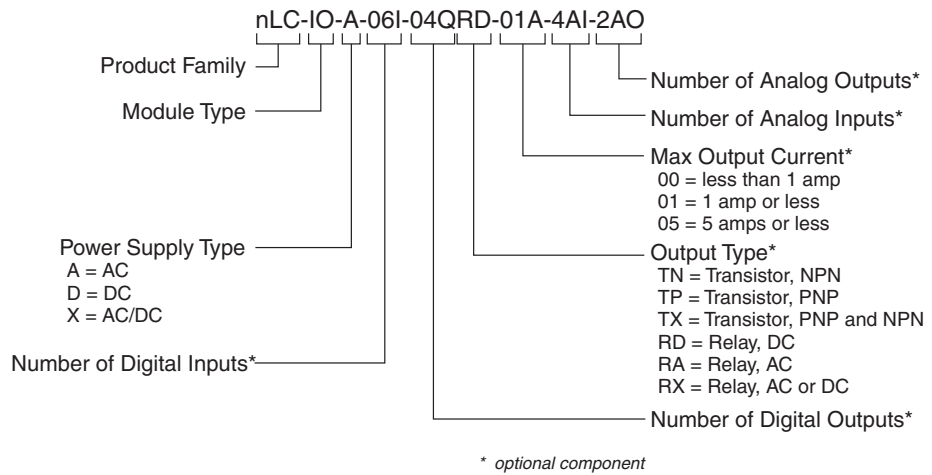

Figure 1-3 NLC-IO... expansion module type codes

1.1.3 Communication expansion modules

Communication expansion modules (NLC-COM-*ttt*) are used to place a control system on a network. Appropriate connectors for the type of communication are included on the NLC-COM-.... For instance, an Ethernet-capable module uses an RJ45 connector.

Different expansion modules are required for different network types but only one communication expansion module can be connected to the base unit at a time (a second network can be connected through the RS-232 or RS-485 base unit option module).

Communication expansion modules are always connected on the left side of the base unit. A female D-SUB 9 connector located on the right side of the module connects to a male D-SUB 9 connector on the left side of the base unit.

1.1.4 Option module

Base unit option modules (NLC-MOD-...) are placed in the appropriate slot on the base unit. A variety of option modules are available to accomplish specific purposes.

The slots for NLC-MOD-... modules are located on the face of the base module. The slots are numbered 1 or 2, so the proper option module can be placed in the proper slot.



NOTE:

Option modules are not keyed to prevent entry into an incorrect slot. However, option modules are not interchangeable between slots. Option modules intended for Slot 1 must only be inserted in Slot 1, and option modules intended for Slot 2 must only be inserted in Slot 2. Each slot is labeled on the face of the base unit, and each option module includes a numeric indicator to indicate which slot is acceptable.

Blanks are used to fill the slot when a module is not used. If a base unit option module is removed, place the blank in the slot to prevent ingress of dirt and dust.

1.2 Operator Panel

To provide an interface to the control system, an Operator Panel (NLC-OP...) can be installed in, or attached to, the base unit. Two different sizes of Operating Panel are available:

1.2.1 NLC-OP1-LCD-032-4X20

The NLC-OP1-LCD-032-4X20 can be mounted directly on the base unit or remotely, such as in an enclosure door panel. When mounting remotely, a Receptor Panel is placed in the slot on the base unit, and a 1 m (3 ft.) cable connects the Receptor Panel and the remotely mounted Operator Panel. In this way, a single NLC-OP-... can be shared between multiple base units. The Operator Panel is hot-swappable and doesn't require rebooting the controller.

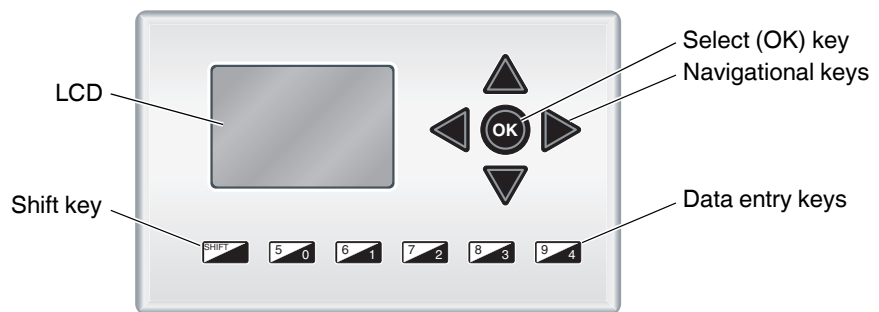

Figure 1-4 Nanoline Operator Panel (NLC-OP1-LCD-032-4X20)

The Nanoline Operator Panel includes an 8-line, 21-character Liquid Crystal Display (LCD), four navigation keys, an <OK> or select key, a <shift> key and five data entry keys.



User-programmed screens are limited to 4 lines with 20 characters (normal text), 2 lines with 10 characters (large text) or a combination of normal and large text.

When a user interface is created within nanoNavigator, the navigational keys allow selection of the various screens and fields within the screens.

- Navigational keys: These allow selection of various screens and fields, or lines, on the LCD.
- Select <OK> key: This selects an option within the screen, allowing selection of another level of screen navigation. This is also used to enter the "edit" mode of a field for data entry.
- Data entry key: These five keys allow entry of numeric values (0 through 4) into a field. The data entry keys can be programmed as digital inputs to allow selection within the software.
- Shift key: This works in conjunction with the data entry keys to obtain values 5 through 9. Press and hold the Shift key while pressing a 0 to 4 key enters the comparable 5 to 9 value.

1.2.2 NLC-OP2-LCD-076-4X20

The NLC-OP2-LCD-076-4X20 Operator Panel is mounted remotely and attaches to the Receptor Panel placed in the slot on the base unit. An RS-232 cable connects the Receptor Panel to the remotely mounted Operator Panel up to 15 m away.

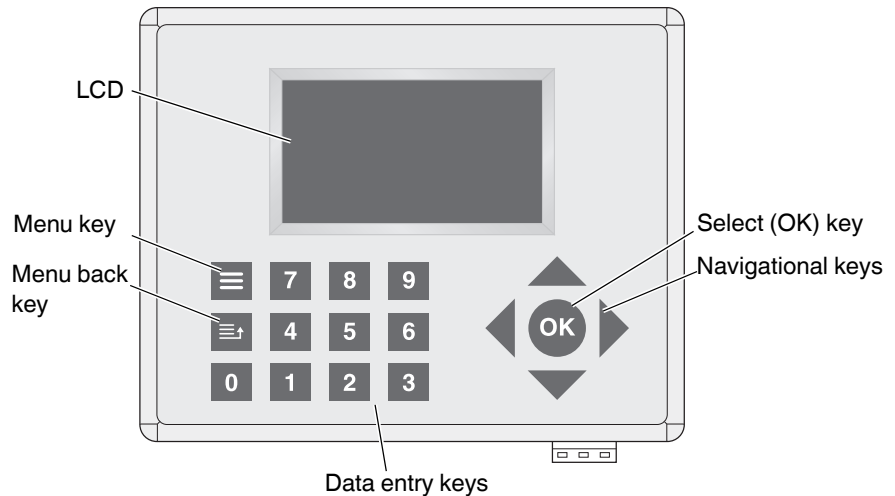

Figure 1-5 Nanoline Operator Panel (NLC-OP2-LCD-076-4X20)

The Operator Panel is hot-swappable and doesn't require rebooting the controller. The NLC-OP2-LCD-076-4X20 is not powered from the NLC... and requires a separate, 12 or 24 V DC power source.

Additional information on the Operator Panels is provided in Section 5, "Operator Panel usage".

1.3 nanoNavigator programming software

Programming is accomplished using nanoNavigator programming software. To provide a simple-to-understand controller, nanoNavigator provides:

- control logic development using either flow chart or ladder chart programming
- easy-to-use human machine interface (HMI) development
- complete I/O interface definition
- ability to monitor running Nanoline controllers
- simulation of a project before loading it onto a controller

To program the Nanoline control system, simply select the desired flow chart blocks and populate them with input and output data. Connect the blocks, download the program to the controller, and it's operational.

Using nanoNavigator, the programmer can create screens for display on the Operator Panel. The screens not only display the desired data but can prompt for input from the operator.

nanoNavigator software runs on a PC using a Windows® 2000 or newer, 32- or 64-bit operating system. nanoNavigator software is available for download at phoenixcontact.com.



For more information on using the nanoNavigator software, refer to the nanoNavigator User Manual.

2 Installation and connection of Nanoline components

As modular devices, the Nanoline system components are simple to connect and configure for specific applications. In addition to selecting the correct base unit, additional I/O modules (with the desired I/O mix), communication modules and an Operator Panel can be selected for the specific application.

2.1 Base and expansion module installation

The base unit and expansion modules install on NS 35 mounting rail (EN 60715). A release latch is located on the bottom side of each module. Up to three I/O expansion modules can be attached to the right side of the base unit, and one communication expansion module can be attached to the left side of the base unit.

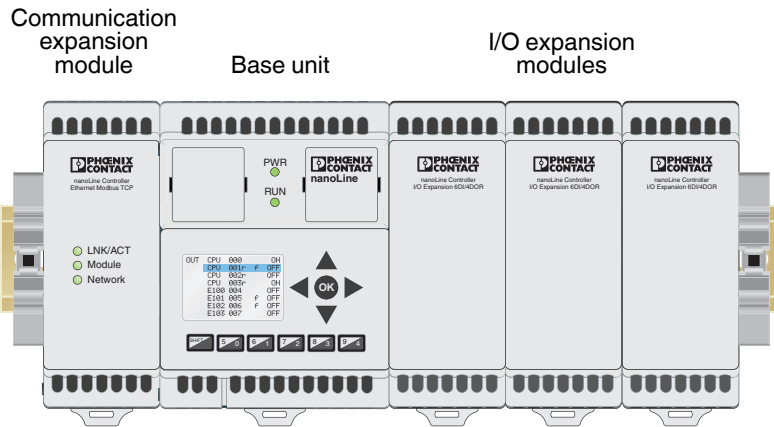

Figure 2-1 Module locations

2.1.1 Installing modules on the mounting rail



NOTE:

The Nanoline is intended for vertical mounting (DIN rail attached to a vertical wall). This aids in cooling by allowing air flow through the base unit and any installed modules. Install the Operator Panel and any option modules in the base unit before mounting the unit.

1. Use a small screwdriver to remove the plastic over the D-SUB 9 connector on the appropriate side of the base module before mounting the module on the rail.



NOTE:

Do not remove the plastic cover when not installing an expansion module.

- Remove the left-side plastic to connect a communication expansion module.
- Remove the right-side plastic to connect I/O expansion modules.

2. Pull the release latch out before positioning the base unit on the mounting rail.

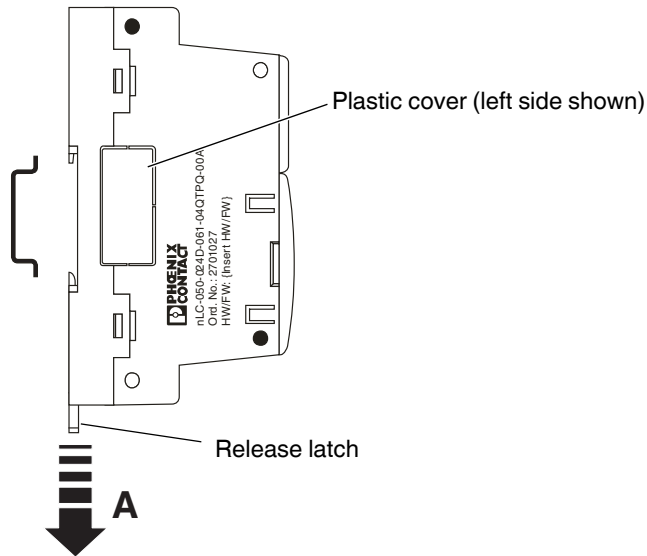

Figure 2-2 Base unit release latch

3. Hook the unit onto the mounting rail.
4. Swivel the module fully onto the rail and push the release latch in to secure it to the rail.

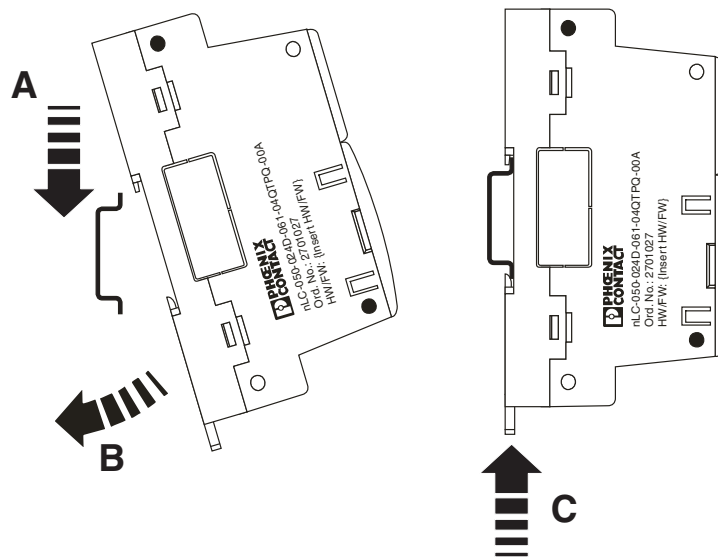

Figure 2-3 Rail placement

5. If multiple I/O expansion modules are to be installed, remove the right-side plastic cover on all but the last module. For example, if two I/O expansion modules will be installed, remove the cover on the first module but not the second.

**NOTE:**

The right-most module must always have the plastic cover over the D-SUB 9 connector installed.

6. Repeat steps 2.- 4. for all expansion modules, placing the communication expansion module (maximum of one) on the left side of the base unit and I/O expansion modules (maximum of three) on the right side of the base unit.
7. Slide the communication expansion module to the right against the base unit. A slight resistance will be felt as the D-SUB 9 connectors mate.
8. Slide any I/O expansion modules to the left against the base unit. A slight resistance will be felt as the D-SUB 9 connectors mate.
9. Repeat step 8. for any additional I/O expansion modules. A maximum of three modules can be attached to a base unit.

2.1.2 Removing modules from the mounting rail

To remove a Nanoline base unit or module from the mounting rail:

**CAUTION:**

Always disconnect power to the system at the power source before removing any components from the mounting rail. Do not remove power wires from the connector without disconnecting power at the source.

1. Disconnect power to the base unit at the power source. If input/output wiring is to be disconnected, disable any separate power supplies attached to affected I/O devices.
2. Disconnect the power supply wires to the base unit.
3. If expansion modules are to be removed, disconnect any input/output wiring to I/O expansion modules or network connections to the communication expansion module.



If only the base unit is to be removed, it may be possible to slide the expansion modules to the side, if sufficient wire length and mounting rail space are available, without disconnecting I/O wires.

4. If expansion modules are installed, slide them away, one at a time, from the base unit. Slide communication expansion modules to the left and I/O expansion modules to the right.

**NOTE:**

Do not slide multiple I/O expansion modules as a group as damage to the interfacing connectors may occur.

- If the base unit is to be removed, disconnect any input/output wiring.

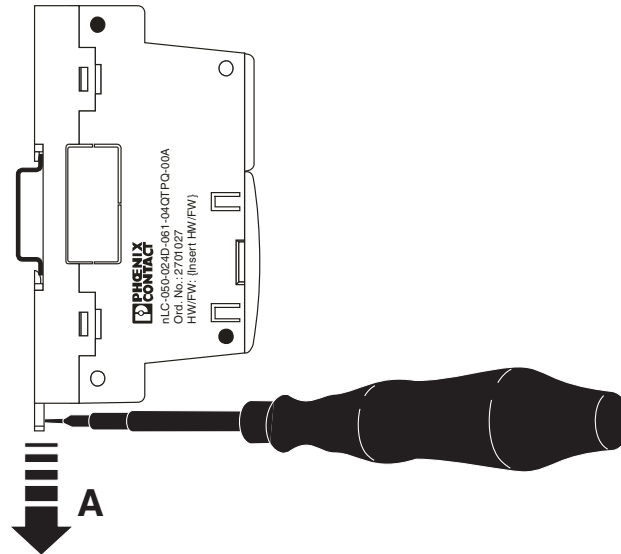

Figure 2-4 Latch release for module removal

- With all wires to the module disconnected, use a small screwdriver to pull down on the release latch and lift the module off the mounting rail.

2.2 Option modules

Base unit option modules are installed in slots on the face of the base unit. Option modules are specific to a slot and must not be installed in an incorrect location.



NOTE:

Placing an option module in the incorrect slot, or placing it in the slot in the incorrect orientation (rotated), may cause damage to either the option module or base unit or both. Do not force option modules into a slot. They will slide easily when properly aligned. Install the Operator Panel and any option modules in the base unit before mounting the unit.

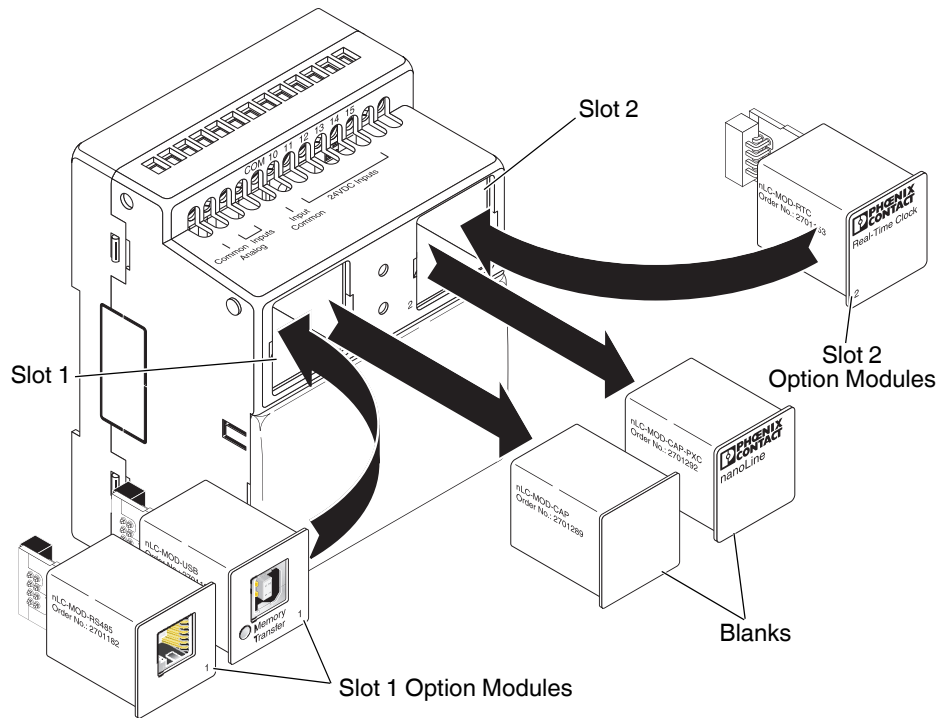

Figure 2-5 Base unit slots

Slot 1 is located on the left side and is typically used for communication and memory modules. Slot 2 is located on the right side and is typically used for the RTC module. A small 1 or 2 is located on the face of the option module to indicate the slot the module may be placed in.

To prevent ingress of dirt and dust, the option module slots are normally covered with a blank. To remove a blank or module, squeeze the two tabs together and pull the blank or module from the base unit. After inserting a module or blank, ensure it is latched in place by pressing the two tabs outward.



NOTE:

Never operate the Nanoline base unit without either a blank or option module installed in the slots.

When the blank is removed, the option module may be inserted into the slot. When installing modules ensure that:

- the module is being placed in the correct slot – Slot 1 only accepts modules with 1 on the lower right corner, and Slot 2 only accepts modules with 2 on the lower left corner.
- the module is oriented properly – text must be oriented the same as other text on the face of the base unit.
- the tabs are properly seated to secure the module in the base unit.

2.2.1 RS-232 connections

To connect the Nanoline to an RS-232 device, the NLC-MOD-RS232 option module (Order No. 2701179) and cable (Order No. 2701234) are required. The cable is a 1 m cable with an RJ11 connector end to plug into the option module and a D-SUB 9 female end to attach to the RS-232 device.

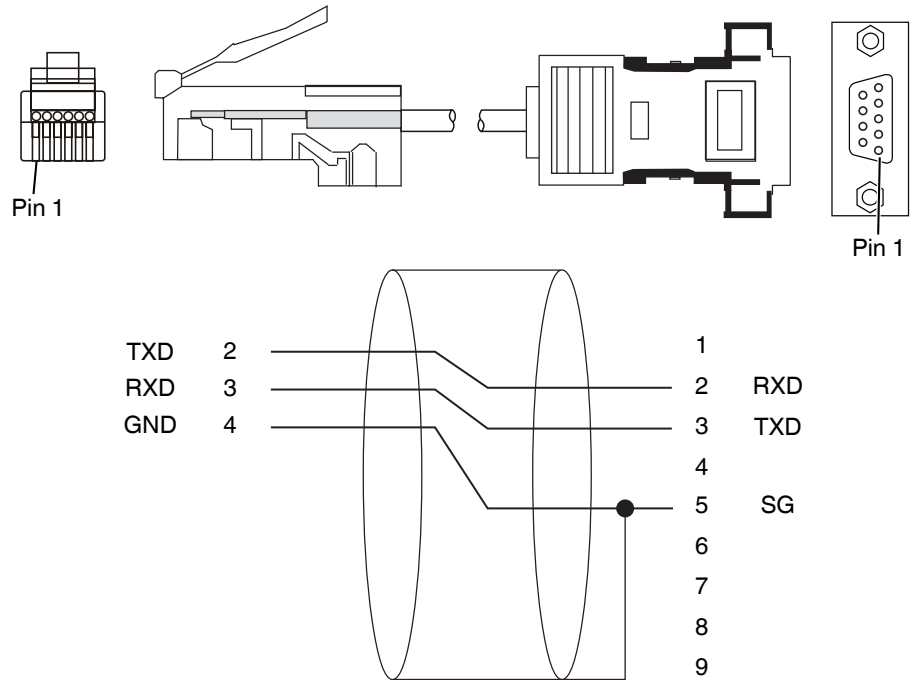

Figure 2-6 RJ11 to D-SUB 9 cable for serial port connection

2.2.2 RS-485 connections

To connect the Nanoline to an RS-485 device, the NLC-MOD-RS485 option module (Order No. 2701182) and cable (Order No. 2701073) are required. The option module is a four-wire RS-485 module capable of Modbus[®] communication. The cable is a 5 m cable with an RJ11 connector end to connect to the option module. The other end is open for connection to whatever type of connector is required. Trim the cable to the desired length before connecting.



The NLC-MOD-RS485 option module supports connection of up to 16 nodes before a repeater is required.

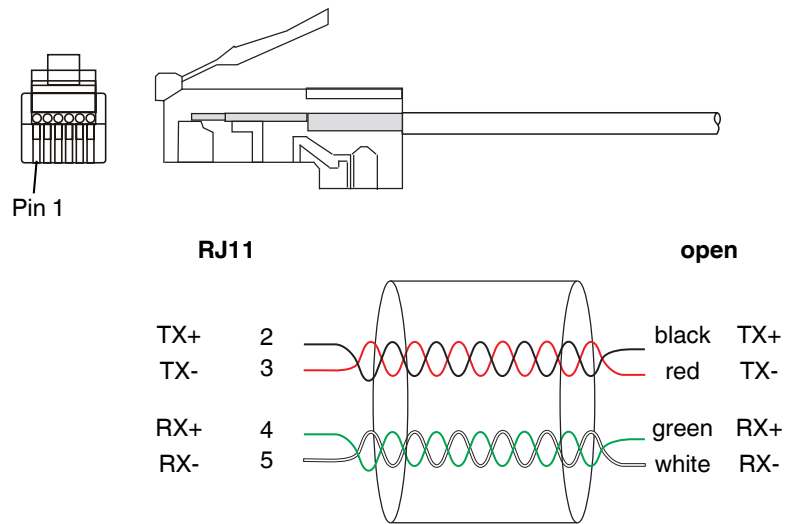

Figure 2-7 RJ11 to open end for 4-wire RS-485 connections



For 2-wire RS-485 communications, jumper TX+ and RX+ together and TX- and RX- together. 2-wire communications limits the Nanoline to performing Modbus commands only. 4-wire communication allows all Nanoline communications (connection, upload and download of projects, Modbus communication, monitoring) except firmware updates.

2.2.3 Modbus network connection (NLC-03... only)

The NLC-035... is capable of two-wire RS-485 connection for Modbus communication. A six-pin RJ12 connector attaches to the bottom of the controller, opposite the power connections.

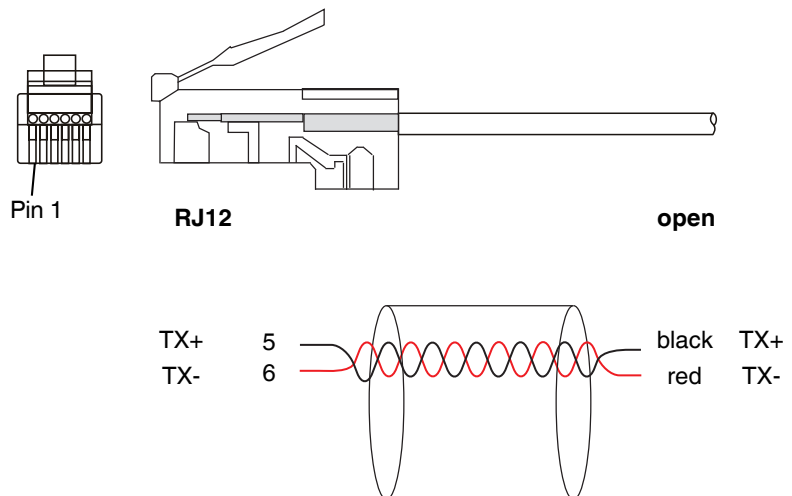

Figure 2-8 RJ-12 to open end for 2-wire RS-485 connection

2.2.4 USB connections

To connect the Nanoline controller to a PC for data transfer, a USB port is often used. To connect to a USB device, the NLC-MOD-USB option module (Order No. 2701195) and cable (Order No. 2701247) are required. The cable is a 2 m cable with a Type A connector to attach to the option module and a Type B connector to attach to the device.

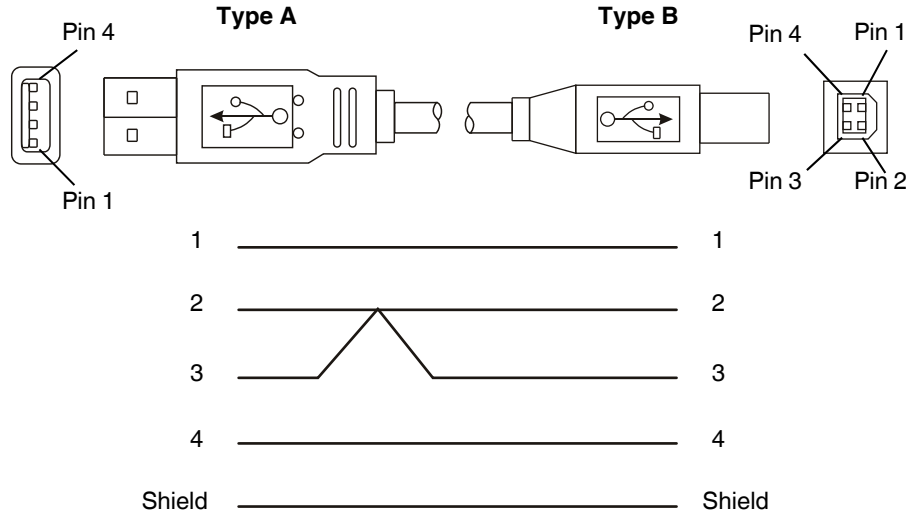

Figure 2-9 USB Type A to USB Type B cable for serial port connection

2.3 Operator Panel

The Nanoline system functions with or without an Operator Panel but often includes the Operator Panel to provide an interface for the user.

The base unit is shipped with a blank in the Operator Panel location. To remove the blank, use a screwdriver and pry the blank out of the base unit. When not using an Operator Panel, the blank must be installed to prevent dirt and dust entry.



NOTE:
 Never operate the Nanoline base unit without either a blank, Receptor Panel or Operator Panel installed in the base unit.
 Do not force option modules into a slot. They will slide easily when properly aligned.
 Install the Operator Panel and any option modules in the base unit before mounting the unit.

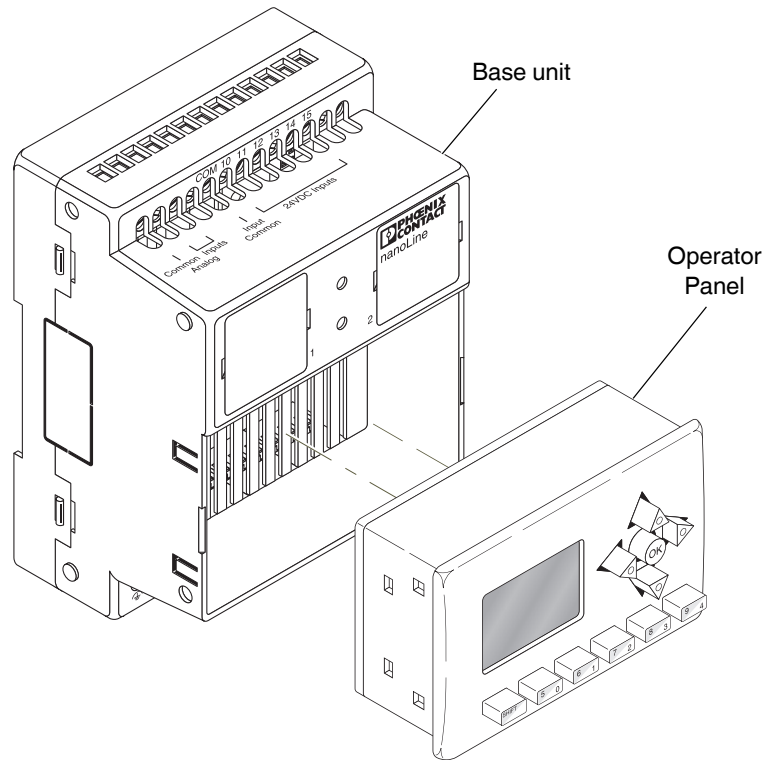

Figure 2-10 Operator Panel location on the base unit

2.3.1 Local installation

To install an Operator Panel directly on the base unit, simply replace the blank with the Operator Panel. The Operator Panel snaps into the base unit housing and is powered through the connector in the base unit.

2.3.2 Remote installation

To use the Operator Panel remotely, a Receptor Panel and display cable are required. This allows the Operator Panel to be used as a hand-held device and shared between Nanoline controllers, or the Operator Panel can be fixed to an enclosure.

The Receptor Panel with RJ45 connector installs in the base unit where the Operator Panel would normally install. The display cable connects the Receptor Panel and Operator Panel, which is either hand-held and used as a service tool, or remotely mounted in an enclosure.

To install the Receptor Panel in the base unit, simply replace the blank with the Receptor Panel. The Receptor Panel snaps into the base unit housing and is powered through the connector in the base unit just like the Operator Panel.



NOTE:

Orient the Receptor Panel so the connector on the back mates with the connector in the base unit slot.

The remote Operator Panel can be mounted in enclosures with a thickness of 1.6 - 2.0 mm. When mounted remotely, the Operator Panel must be within 0.6 m of the base unit for proper communication.



NOTE:

To ensure proper power supply and communication with the Operator Panel, only use a display cable supplied by Phoenix Contact.

NLC-OP1-LCD-032-4X20

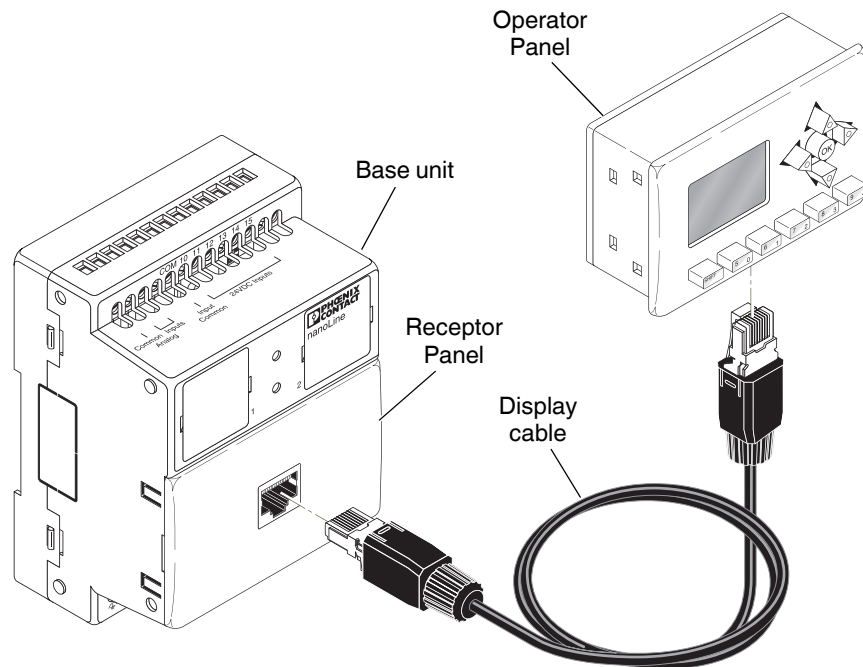

Figure 2-11 Receptor Panel, display cable and remote Operator Panel

To mount the Operator Panel in an enclosure or cabinet:

1. Clear any components around the desired mounting location on the enclosure.

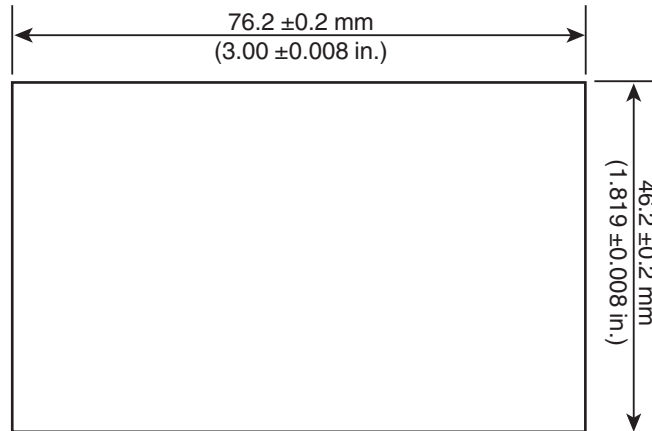

Figure 2-12 Cutout dimensions for panel mounting

2. Using an appropriate tool for the enclosure material, cut a $46.2 \times 76.2 \pm 0.2$ mm hole in the enclosure (see Figure 2-12). Remove any burrs or sharp edges using a file or appropriate tool.



NOTE:

Do not make the hole in the enclosure too large or the Operator Panel will pass through. Do not drill holes for the mounting screws; they do not pass through the enclosure wall.

3. Insert the Operator Panel into the hole from the front.

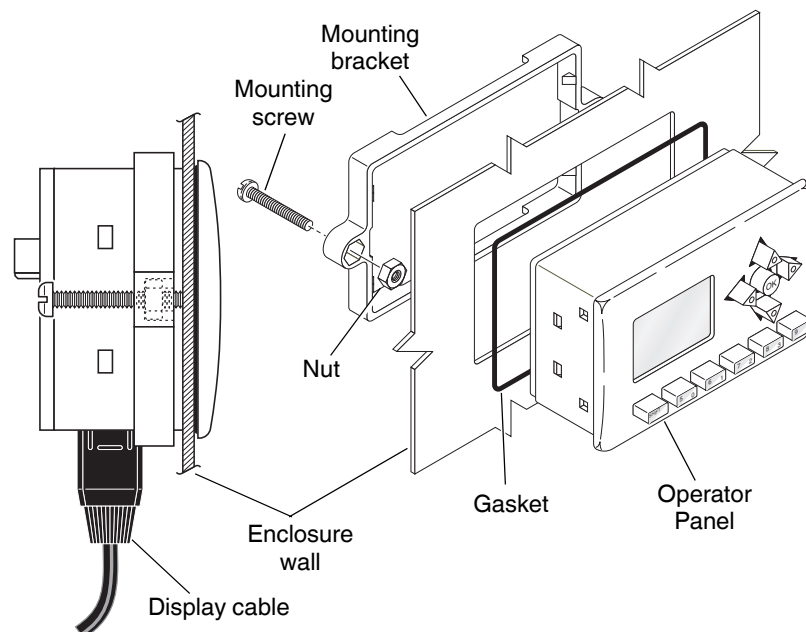

Figure 2-13 Remote Operator Panel installation

4. Thread the nuts onto the mounting screws and place them into the mounting bracket so the nuts are seated in the hexagonal receptors on the bracket.
5. Slide the mounting bracket over the Operator Panel from the back with the bolt heads extending rearward and the thread end against the enclosure wall (see Figure 2-13). Continue to slide the bracket forward until the latches on the mounting bracket snap into the receiver holes in the Operator Panel housing.
6. Insert the Operator Panel into the enclosure cutout.
7. Turn the screws clockwise until they contact the surface of the enclosure. Then turn them 1-2 more turns to cause tension on the mounting bracket.



NOTE:
 Undertightening the screws will not secure the Operator Panel in the enclosure. Overtightening the screws may cause the mounting bracket to break.

8. Connect the Operator Panel to the Receptor Panel using the display cable (Order No. 2701438).

NLC-OP2-LCD-076-4X20

Connection of the NLC-OP2-LCD-076-4X20 requires assembly of a cable. For NLC-05... base units a 8-pin RJ45 connector attaches to the Receptor Panel. For NLC-03... base units, an 6-pin RJ12 connector attaches directly to the base unit. A D-SUB 9 male connector attaches to the Operator Panel.

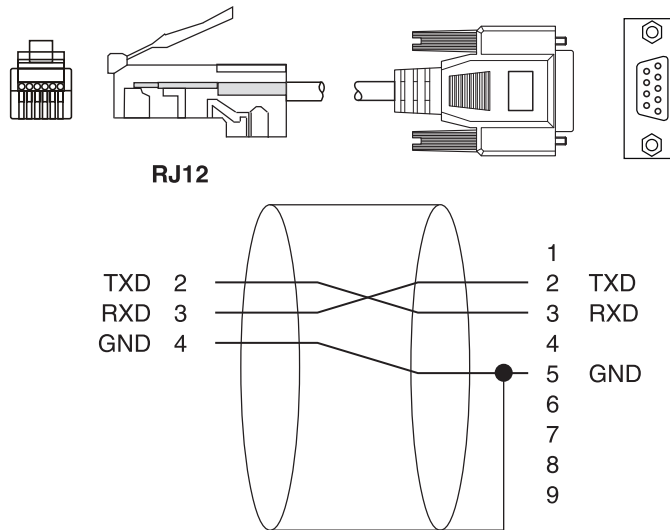

Figure 2-14 RJ12 to D-SUB 9 cable

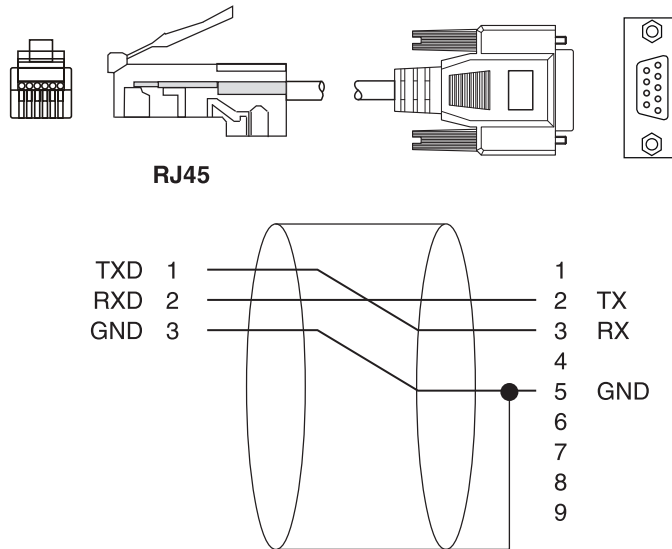

Figure 2-15 RJ45 to D-SUB 9 cable

By building the cable locally, it can be manufactured to the desired length.



Communication between the base unit and Operator Panel is via RS-232. This standard has a maximum length of 15 m.

To mount the Operator Panel in an enclosure or cabinet:

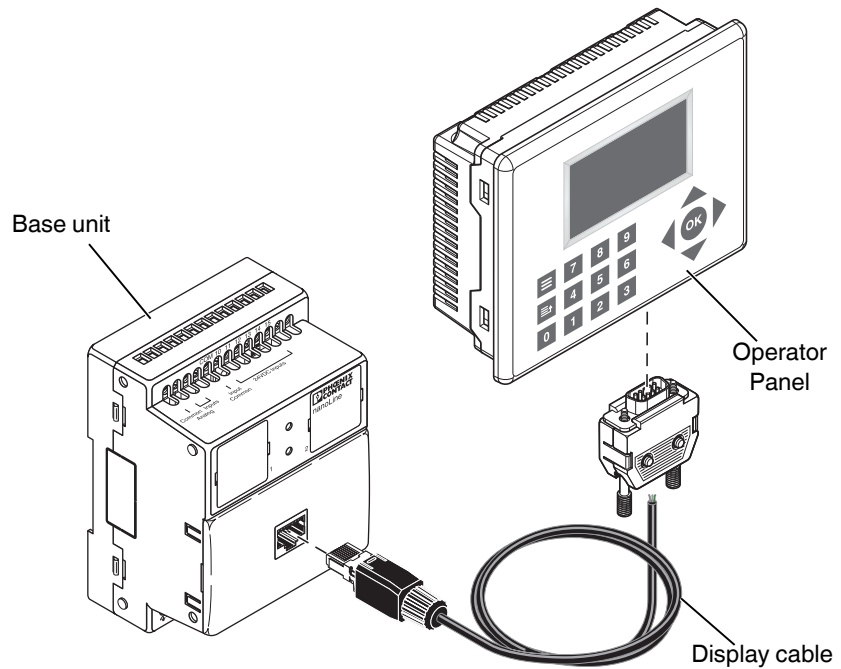

Figure 2-16 Remote Operator Panel installation

1. Clear any components around the desired mounting location on the enclosure.
2. Using an appropriate tool for the enclosure material, cut a 119 x 93 ±0.5 mm hole in the enclosure. Remove any burrs or sharp edges using a file or appropriate tool.



NOTE:

Do not make the hole in the enclosure too large or the Operator Panel will pass through. Do not drill holes for the mounting screws; they do not pass through the enclosure wall.

3. Place the four J-hooks in the slots on the sides of the Operator Panel. Alternating between the J-hooks, turn the screws in the J-hooks clockwise until they tighten against the enclosure. Torque each J-hook screw to 0.5 - 0.6 Nm.

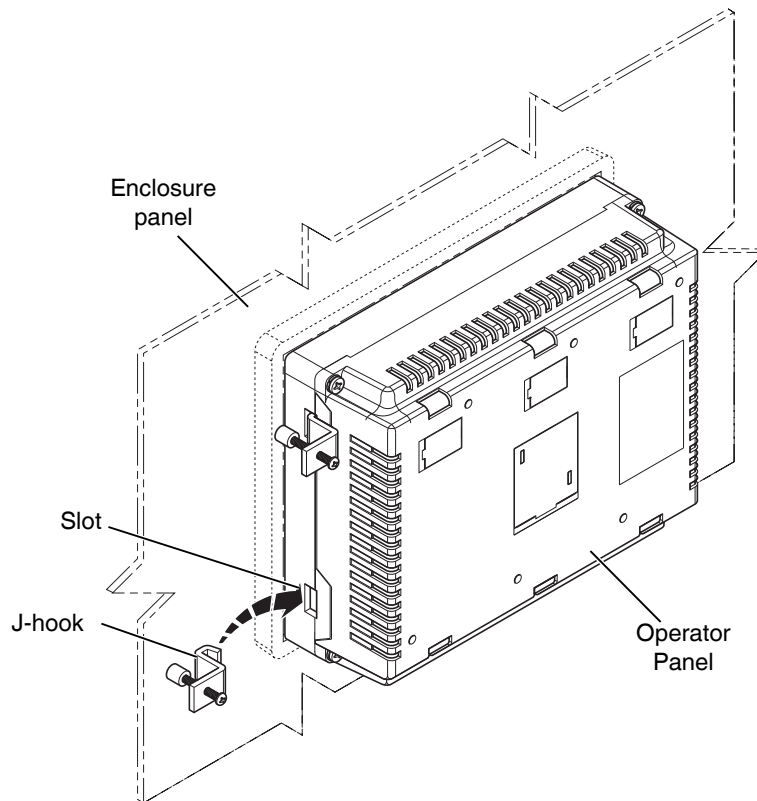

Figure 2-17 Remote Operator Panel installation

2.4 Connecting power, inputs and outputs

The Nanoline system components use a screw connection technology for power and I/O connection. Individual connection points are labeled on the housing surface with appropriate identifiers. Use a small screwdriver to turn the screw counterclockwise to release and clockwise to tighten wires after insertion into the appropriate position.



CAUTION:

Do not apply power to the Nanoline controller until directed to do so in the commissioning (startup) procedure.



NOTE:

The nLC-05...024... module is designed for SELV and PELV operation according to IEC 61140/EN 61140.



Not all terminals in the housing are connected and have a function. Only insert wires into the correct housing cutouts.

2.4.1 Power

The power supply requirement differs based on the model purchased and is either 12 V DC, 24 V DC, 24 V AC, 100-240 V AC or some combination. Each base module is labeled to indicate the nominal voltage. The connection terminals accept 0.14-2.5 mm² (14-26 AWG) wire.

A functional earth ground for the chassis is provided to direct any transients away from attached modules and components.



Order No. 2701069 requires installation of Order No. 2701070 to meet CE compliance.

Power always connects to the base unit that powers any installed modules. Inputs and outputs are optically isolated from the power input to the base unit.

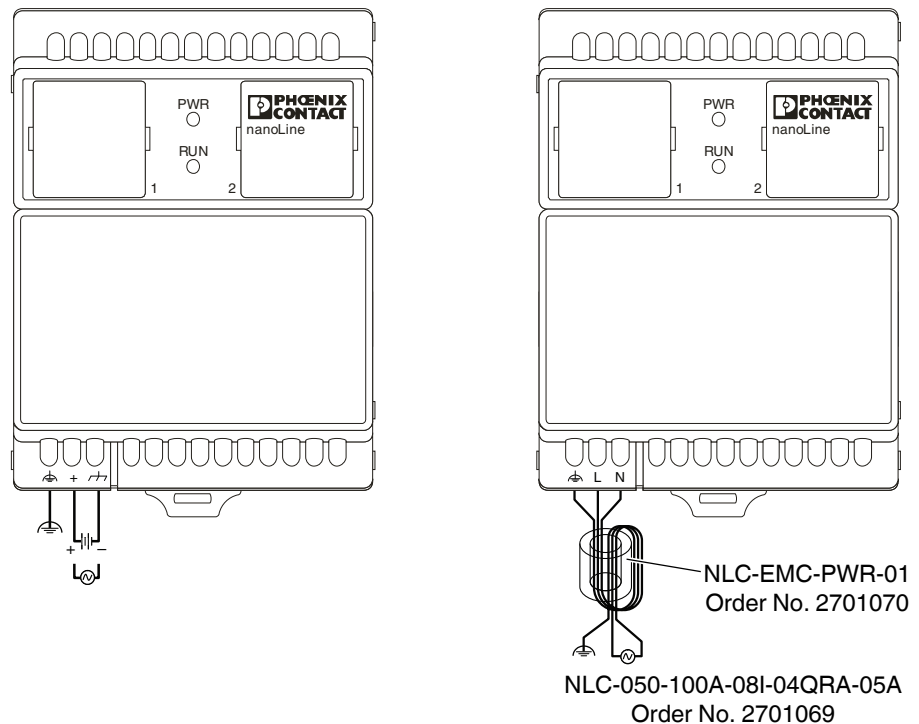

Figure 2-18 Power connections

2.4.2 Digital inputs

Digital (transistor) inputs can be located on either the base unit or optional I/O expansion modules.

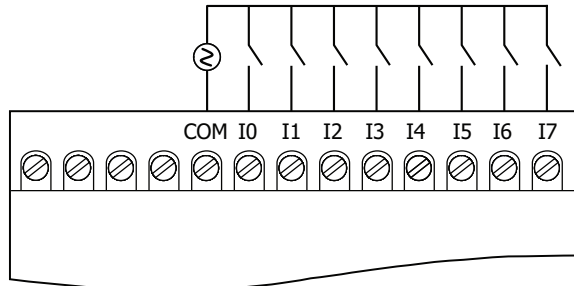

Figure 2-19 AC-type input connections (base unit shown)

Input devices can be connected to DC-powered controllers as either a sinking (NPN) input, with the return switched, or sourcing (PNP) input, with the signal switched.



Do not mix input connection methodology. All inputs must be wired as PNP or NPN. PNP and NPN inputs apply to DC connections only.

A common power source can be used for the power supply and I/O devices, or the I/O devices can be powered from a separate power supply. The I/O channels are optically isolated from the input power.

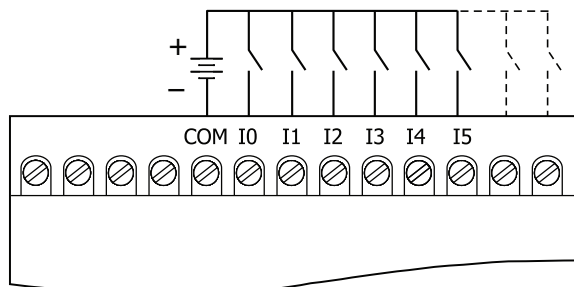

Figure 2-20 PNP-type input connection (base unit shown)

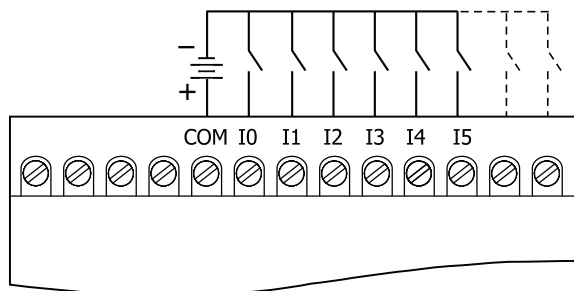

Figure 2-21 NPN-type input connection (base unit shown)

Terminals are labeled as COM, shared by all channels, or Ix where x indicates the channel number. Channel numbering starts with 0.

2.4.3 Digital outputs

24 V DC systems with digital outputs can connect to devices as either a sinking (NPN) output, with the return switched, or sourcing (PNP) output, with the signal switched.

Output channels are labeled as Qx where x indicates the channel. Channel numbering starts with 0. Positive (+) and negative (-) terminals are common for all channels.

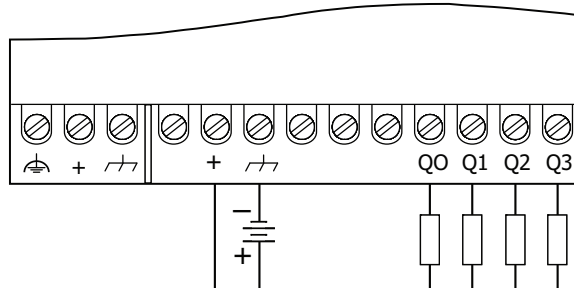

Figure 2-22 Digital NPN output connection (base unit shown)

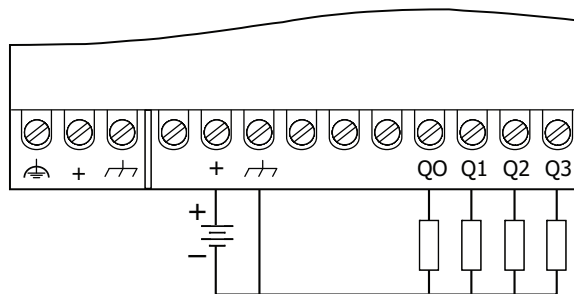

Figure 2-23 Digital PNP output connection (base unit shown)

2.4.4 Analog inputs

Analog inputs can be located on either the optional I/O expansion module or some base units. Each input channel has a signal and return terminal, labeled as Ax+ or Ax- where x indicates the channel number. Channel numbering starts with 0.

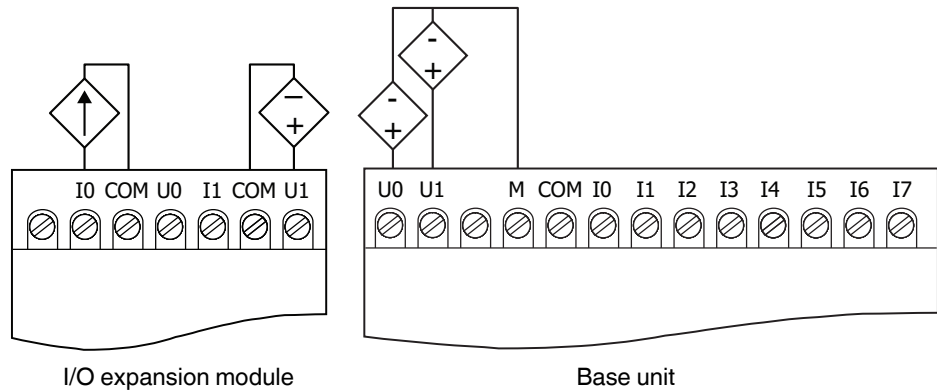

Figure 2-24 Analog input connection

Connected devices may be either 3-wire or 4-wire devices. For 0-10 V devices, a separate 10 V power supply is required.

2.4.5 Analog outputs

Analog outputs are located on optional expansion modules only. Each output channel has a current or voltage signal.

The analog output module requires a separate 24 V DC power supply.

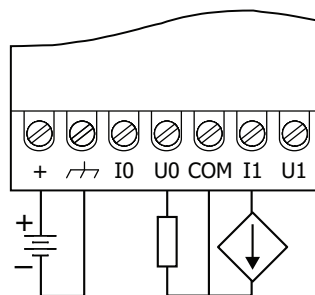

Figure 2-25 Analog output connection

Each output channel has a current or voltage signal. Terminals are labeled as COM, shared by all channels, Ix where I indicates current output or Ux where U indicates a voltage output. The x indicates a channel number. Channel numbering starts with 0.

2.4.6 Relay outputs

Relay outputs can be located on either the base unit or optional I/O expansion module. Each output channel is rated for 5 A.

Output channels are labeled as Qx where x indicates the channel. Channel numbering starts with 0. A 1 or 2 indicates the terminals for each channel.

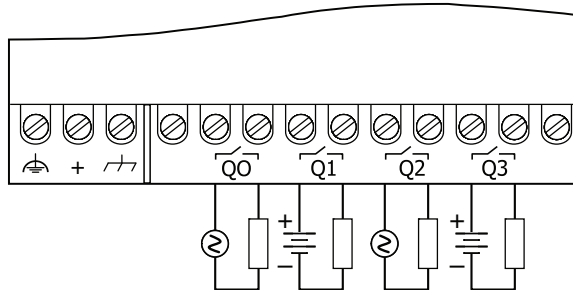

Figure 2-26 Relay output connection (base unit shown)

Relay outputs are capable of switching 5 A @ 120 V AC or 5 A @ 24 V DC, regardless of the input voltage.

Interference suppression measures on inductive loads/switching relays

Each electrical load is a mix of ohmic, capacitive, and inductive elements. Depending on the proportion of the elements, switching these loads results in a larger or smaller load on the switch contact.

In practice, loads are generally used with a large inductive element, such as a contactor, solenoid valve or motor. Due to the energy stored in the coils, voltage peaks of up to a few thousand volts may occur when the system is switched off. These high voltages cause an arc on the controlling contact, which may destroy the contact through material vaporization and material migration. This pulse, which is similar to a square wave pulse, emits electromagnetic pulses over a wide frequency range (spectral elements reaching several MHz) with a large amount of power.

To prevent such arcs from occurring, the contacts/loads must be fitted with protective circuits. In general, the following protective circuits can be used:

- contact protective circuit
- load protective circuit
- combination of both protective circuits

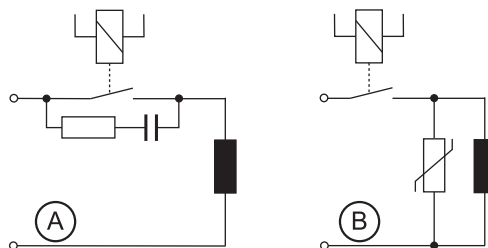

Figure 2-27 Contact protective circuit (A), load protective circuit (B)

If sized correctly, these circuit types do not differ greatly in their effectiveness. In principle, safety equipment should intervene directly at the source of the interference. The following benefits are provided when a load protective circuit is used:

- when the contact is open, the load is electrically isolated from the operating voltage.
- it is not possible for the load to be activated due to undesired operating currents, e.g., from RC elements.
- shutdown voltage peaks cannot be coupled in control lines that run in parallel.

Table 2-1 highlights the advantages and disadvantages of typical relay circuits.

Table 2-1 Circuit versions

Protecting the load	Additional delay	Defined induced voltage limitation	Bipolar effective attenuation	Advantages/disadvantages
<p>Diode</p> 	Long	Yes (U_D)	No	<p>Advantages:</p> <ul style="list-style-type: none"> Easy implementation Cost-effective Reliable Non-critical sizing Low induced voltage <p>Disadvantages:</p> <ul style="list-style-type: none"> Attenuation only via load resistor Long delay
<p>Series connection diode/Zener diode</p> 	Medium to short	Yes (U_D)	No	<p>Advantages:</p> <ul style="list-style-type: none"> Non-critical sizing <p>Disadvantages:</p> <ul style="list-style-type: none"> Attenuation only above U_{ZD}
<p>Suppressor diode</p> 	Medium to short	Yes (U_D)	Yes	<p>Advantages:</p> <ul style="list-style-type: none"> Cost-effective Non-critical sizing Limits positive peaks Suitable for AC voltage <p>Disadvantages:</p> <ul style="list-style-type: none"> Attenuation only above U_{ZD}

Table 2-1 Circuit versions

Protecting the load	Additional delay	Defined induced voltage limitation	Bipolar effective attenuation	Advantages/disadvantages
<p>Varistor</p> 	Medium to short	Yes (U_D)	Yes	<p>Advantages:</p> <ul style="list-style-type: none"> High power absorption Non-critical sizing Suitable for AC voltage <p>Disadvantages:</p> <ul style="list-style-type: none"> Attenuation only above U_{ZD}
<p>R/C combination</p> 	Medium to short	No	Yes	<p>Advantages:</p> <ul style="list-style-type: none"> HF attenuation via power store Suitable for AC voltage Level-independent attenuation Reactive current compensation <p>Disadvantages:</p> <ul style="list-style-type: none"> Exact sizing required¹ High inrush current
<p>R/C combination with diode</p> 	Medium to short	No	Yes	<p>Advantages:</p> <ul style="list-style-type: none"> HF attenuation via power store Level-independent attenuation Reactive-current compensation <p>Disadvantages:</p> <ul style="list-style-type: none"> Exact sizing required¹ Only suitable for DC voltage

¹ Capacitor sizing: $C = L_{Load} / 4 \times R_{Load}^2$
 Resistor sizing: $R = 0.2 \times R_{Load}$

2.4.7 Temperature inputs

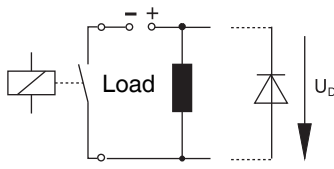
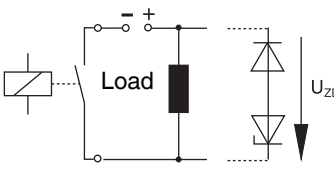
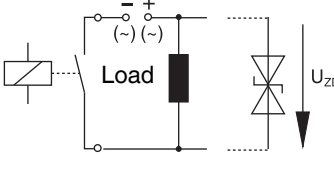
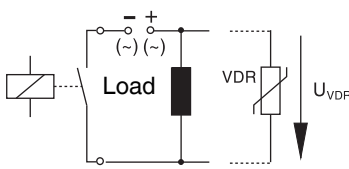
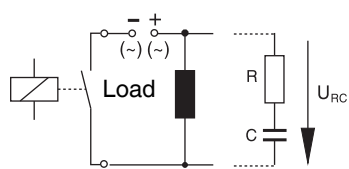
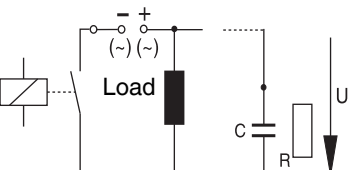
Temperature inputs are available only on the optional I/O expansion module. The connection method varies depending upon the type of sensor being connected.



Only two- and three-wire sensors can be utilized.

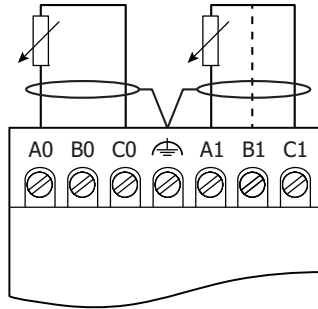

Figure 2-28 PT100/PT1000 connection

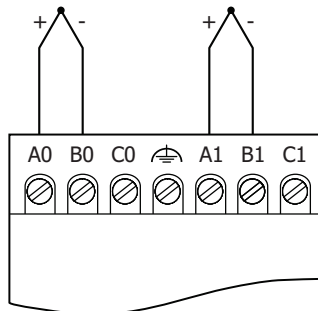

Figure 2-29 Thermocouple connection

Each input channel has signal (Ax), sense (Bx) and return (Cx) terminals, where x indicates the channel number. A common ground is available to attach the shield.

2.5 LED indicators

2.5.1 Base unit

The LED indicators on the base unit indicate the following:

Table 2-2 Base unit LED indication

LED	LED status	Indication
RUN	ON	Valid project present and running with no faults or warnings
	OFF	Valid project present and stopped, or no power present
	1/3-second flash	Fault exists and project stopped
	1-second flash	Valid project present and running but with warnings
PWR	ON	Power is present
	OFF	No power is present

3 Communication

Control applications are designed using the nanoNavigator configuration software. Communication between the Nanoline base unit and a PC is required to download these control applications. The application can also be monitored using nanoNavigator.



Refer to the nanoNavigator online help for specific information on using the software.

Nanoline products can also be connected to other devices with the optional NLC-COM-ENET-MB1 (Ethernet), NLC-COM-GSM (GSM) or NLC-COM-CELLULAR-CDMA (Verizon® cellular) communication modules. Communication is via the Modbus® RTU or Modbus TCP protocol (Ethernet module) or SMS messaging.



The NLC-COM-CELLULAR-CDMA module is licensed and approved for use on a Verizon network.



Refer to the UM EN NLC-COM-GSM User Manual (2759) for specific information on configuration of the NLC-COM-GSM and NLC-COM-CELLULAR-CDMA modules.

3.1 Serial connections

The Nanoline provides flexibility in connecting to other devices and networks through serial communication. Serial communication connects the controller to a PC for downloading or monitoring an application. Serial connection is accomplished through an option module installed on the base unit, either RS-232, RS-485 or USB.

An additional option for data transfer allows downloading of a control application from a PC running nanoNavigator to a memory module through a USB port. The memory module can be inserted into a base unit and the control application saved to the on-board memory. The memory module can be removed from the base unit.

When using the RS-232 or RS-485 module, the controller can exchange data using the Modbus RTU protocol.

3.1.1 RS-232

RS-232 communication with the base unit requires the NLC-MOD-RS232 option module (Order No. 2701179) installed in Slot 1 and NLC-PC/SERIAL-CBL 1M (Order No. 2701234). For installation procedures, refer to “Option modules” on page 14. The cable connects between the RJ11 connector on the option module and a D-SUB 9 serial port on a PC.

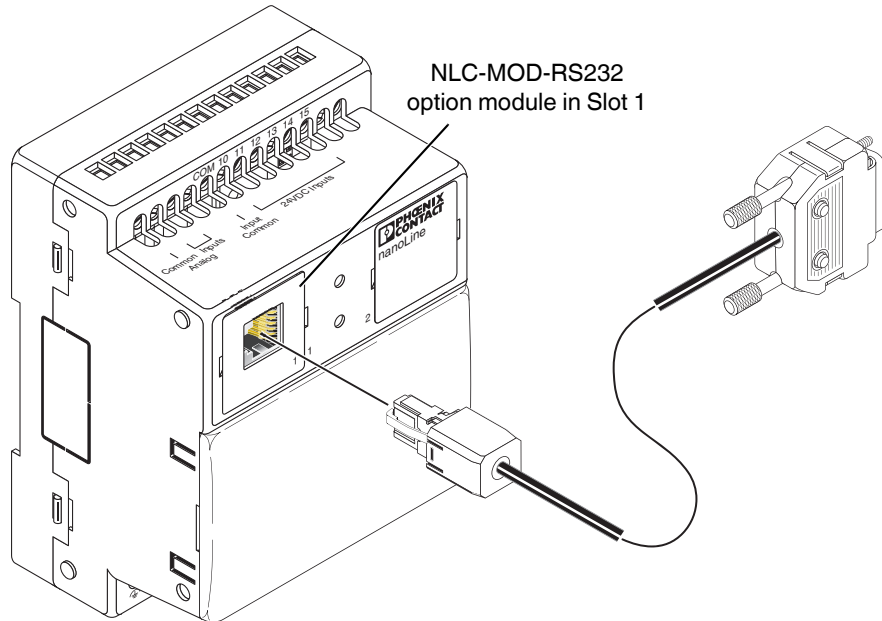

Figure 3-1 Serial communication with PC (NLC-PC/SERIAL-CBL 1M cable shown)

Before communication can be established, configure the port to communicate with the Nanoline.

1. Open the “Start... Control Panel... System” dialog box, click the “Hardware” tab, then click the “Device Manager” button.
2. Click the + icon next to Ports to expand the selections.
3. Double-click the desired port (COM1) to open the “Communications Port” dialog box.
4. Click the “Port Settings” tab. Set the various fields as follows:

Bits per second	9600
Data bits	8
Parity	none
Stop bits	1
Flow control	none

5. Click the “OK” button when finished.

3.1.2 RS-485

RS-485 communication with the base unit requires the NLC-MOD-RS485 option module (Order No. 2701182) installed in Slot 1 and NLC-RS485-CBL-5M (Order No. 2701073). For installation procedures, refer to “Option modules” on page 14. The cable connects between the RJ11 connector on the option module and an RS-485 device.



Most PCs are not equipped with an RS485 connector. To communicate with a PC for configuring purposes (or any other RS-232 device) an RS-232 to RS-485 converter can be used. Refer to 3.1.1 “RS-232” for instructions on establishing an RS-232 connection.

3.1.3 USB

USB communication with the base unit requires the NLC-MOD-USB option module (Order No. 2701195) installed in Slot 1 and NLC-PC/USB-CBL 1M (Order No. 2701247). For installation procedures, refer to “Option modules” on page 14. The cable connects between the USB Type B connector on the option module and a USB Type A port on a PC.



Communication to a serial device through a USB port requires a special driver. This driver is included with the nanoNavigator configuration software.

Before communication can be established, configure the port to communicate with the Nanoline.

1. Open the “Start... Control Panel... System” dialog box, click the “Hardware” tab, then click the “Device Manager” button.
2. Click the + icon next to Ports to expand the selections.
3. Double-click the desired port (COM1) to open the “Communications Port” dialog box.
4. Click the “Port Settings” tab. Set the various fields as follows:

Bits per second	9600
Data bits	8
Parity	none
Stop bits	1
Flow control	none

5. Click the “OK” button when finished.

3.1.4 Memory Module

The NLC-MOD-MEM 032K option module (Order No. 2701166) allows a project to be transferred from one device to another without a direct connection. Possible transfers are:

- download a project from nanoNavigator to a memory module.
- upload a project from a memory module to nanoNavigator.
- download a project from a memory module to a Nanoline controller.
- upload a project from a Nanoline controller to a memory module.

Transfers to and from the memory module are initiated from nanoNavigator if the memory module is connected to the PC, or from the Operator Panel if the memory module is installed in the base unit. Also, a project can be cleared from the memory module using either nanoNavigator or a Nanoline controller equipped with an Operator Panel.



Transfers using a memory module are always a two-step process. The project is transferred to the memory module by the sending device, and then transferred to either the Nanoline controller or nanoNavigator by the receiving device.

The memory module can be a very convenient tool when transferring the same project to multiple Nanoline controllers, especially if the controllers are installed in remote locations around a site, or a memory module can be used on an assembly line to load the project onto each controller as it is installed.

3.1.4.1 nanoNavigator

The memory module connects to a PC using the NLC-PC/USB-CBL 1M (Order No. 2701247) cable. When connected to a PC, the memory module is powered through the USB cable, just like any USB device.

To access the device through nanoNavigator:

1. Configure the COM port
 - a) Click the “File... Connection Settings” menu.
 - b) Select the appropriate COM port from the “Memory Module” drop-down menu.
 - c) Click the “OK” button.
2. Click the “nanoLC... Memory Module...” menu and select the desired process, either “Download Project” or “Upload Project” as desired. nanoNavigator also has a “Clear Project” selection to remove any existing projects loaded in the memory module.
3. When the project is finished transferring or deleting, the dialog box closes.



The transfer to a memory module is often too fast for the user to see, although the dialog box may flash on the screen.

3.1.4.2 Operator Panel

The memory module is inserted into Slot 1 to communicate with the base unit (refer to “Option modules” on page 14).

To perform “selective” transfers, the base unit must have the Operator Panel installed. If there is no project loaded on the base unit, the program stored on the memory module is automatically transferred to the base unit.

For details on how to selectively perform a transfer from the Operator Panel, see “Memory module” on page 81.

3.1.4.3 Memory module behavior

The memory module performs different operations depending upon where it is installed and the configuration of the Nanoline, and whether there is a project stored in memory.

Table 3-1 indicates what action happens when a Nanoline system has power applied while a memory module is installed.

Table 3-1 Memory module behavior at start-up

Base unit		Memory module	
		Program	No program
No Operator Panel	Program	Project transferred from memory module to base unit ¹ .	Project transferred from base unit to memory module.
	No program	Project transferred from memory module to base unit ¹ .	Nothing.
With Operator Panel (see "Memory module" on page 81)	Program	Nothing. The transfer is controlled using the Operator Panel.	Project transferred from base unit to memory module.
	No program	Project transferred from memory module to base unit ¹ .	Nothing.

¹ The transfer only takes place if the base unit in memory module project matches the physical base unit.

3.2 Ethernet communication

Connection to an Ethernet network requires the optional NLC-COM-ENET-MB1 communication expansion module. This attaches to the base unit through a D-SUB 9 connector on the side of each unit. Ethernet connection is through an RJ45 port on the front of the module.

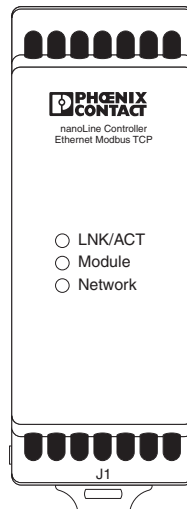

Figure 3-2 NLC-COM-ENET-MB1 communication expansion module



The NLC-COM-ENET-MB1 and NLC-050-100A-08I-04QRA-05A cannot be used together and still meet CE compliance.

3.2.1 LEDs

Three LEDs on the module indicate communication status of the Ethernet module.

Table 3-2 NLC-COM-ENET-MB1 LED flash rates

LED	LED Status	Indication
LINK/ACT	ON	Link established, no communications
	flashing	Receive or transmit communications
Module	ON	Ethernet module OK, communication with the base unit is OK, IP Address set
	slow flash	Ethernet module OK, no base unit communication
	fast flash	Ethernet module OK, communication with the base unit is OK, waiting for IP Address
	off	No power or module failure
Network	ON	Good link and at least one active Modbus connection
	flash	Modbus watchdog timeout
	OFF	No Modbus connection

3.2.2 Communications watchdog

When using the Nanoline as an intelligent, real-time I/O device in a control application, it is important to know if the communication connection to a master controlling device is terminated. Since multiple Ethernet switches can be between the master and slave devices, the physical link from the Nanoline to the nearest switch can be OK while the controller is disabled, powered down or in a “program” mode.

The Ethernet module must receive a write data command within a specified watchdog time period. The time delay for the communications watchdog is configured by the user in the nanoNavigator configuration dialog box from 0.0 (OFF) to 25.5 seconds in 0.1-second increments. The watchdog value is in the native integer format of the Nanoline.

If the watchdog times out, the “Communications Watchdog” status bit turns ON (transition of watchdog 0>1) and is accessible to the flow chart program using Flag 090. When a Modbus Write command is received, the watchdog bit is turned OFF.

3.3 Cellular communication

The Nanoline is capable of communicating on the Global System for Mobile Communications (GSM) network, if the NLC-COM-GSM (Order No. 2701344) expansion module is installed.

If the NLC-COM-CELLULAR-CDMA (Order No. 2400428) expansion module is installed, the Nanoline is capable of communicating on the Verizon® wireless CDMA network.



The NLC-COM-CELLULAR-CDMA module is certified for use on a Verizon network.



For information on configuration of the NLC-COM-GSM and NLC-COM-CELLULAR-CDMA modules, see the UM EN NLC-COM-GSM (2759).

3.4 Modbus communication

Network communication uses the Modbus TCP protocol when using the Ethernet module. When communicating to the Nanoline using either the RS-232 or RS-485 option module, communication is via the Modbus RTU protocol.

A remote Modbus Client, such as ModScan32 from WinTECH Software Design available at www.win-tech.com/html/modbus1.htm, can be used to communicate with the Nanoline, which functions as a server device.

In addition to Modscan32, the following software may be required.

- Easy IPAssign can be used to configure a specific IP Address on the Nanoline when the Ethernet module is connected. This is available at www.phoenixcontact.com.
- Wireshark is available for download at www.wireshark.org. This provides various network diagnostics, particularly as a network sniffer to locate assigned IP Addresses.

Table 3-3 shows the configuration parameters that apply to the Modbus TCP as implemented in the NLC-COM-ENET-MB1 Ethernet module, and Modbus RTU as implemented in the NLC-MOD-RS485 or NLC-MOD-RS232 option modules. The data definition scan rate for Modbus is set to 500 ms, and the Delay Between Polls is set to 1 ms.

Table 3-3 Modbus TCP and RTU configuration parameters

Write Mode	Read/write mode	Allows read/write Modbus functions
	Read-only mode	Allows only the Modbus read function
Watchdog	0.0 to 25.5 seconds	Sets the delay before an error message is initiated
Fault	Fault setting	
	Warning setting	



Modbus TCP configurations are located in the COM Interface configuration, and Modbus RTU configurations are located in the base unit configuration under Base Option Slot #1 in nanoNavigator.

For more information on Modbus visit www.modbus.org. Additional Modbus tools can be found at www.modbustools.com.

3.4.1 ModScan32

ModScan32 is a software application that operates as a Modbus master. It provides the ability to change data points in a connected slave device using either the RTU or ASCII Transmission mode. The following provides a few common procedures that can be accomplished using ModScan32.

Configuration: Setup - Data definition

In the “Display Definition” dialog box, enter appropriate values for the Scan Rate, Slave Address, Point Type, Point Address and Length (see Figure 3-3).

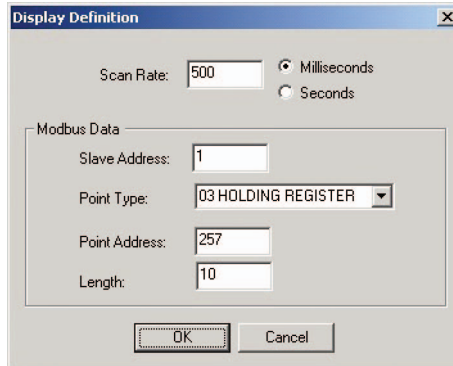

Figure 3-3 “Display Definition” dialog box

Configuration: Connection - Connect with Modbus TCP

1. Click the “Connection... Connect...” menu.
2. From the “Connect Using:” drop-down menu, select “Remote Modbus TCP Server” (see Figure 3-4).

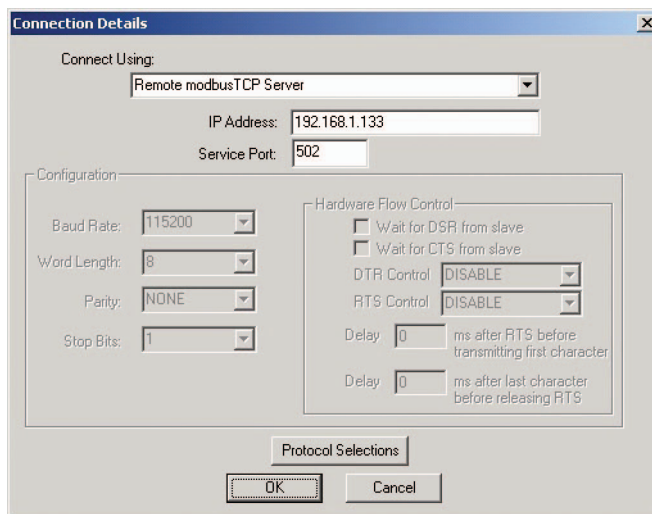

Figure 3-4 “Connection Details” dialog box with remote Modbus parameters

3. Enter the IP Address configured in nanoNavigator in the “IP Address” field. If the IP Address was obtained using DHCP, use Wireshark or an equivalent IP sniffer to determine the IP Address assigned.
4. Enter 502 in the “Service Port” field (the default is 502).
5. Click the “Protocol Selections” button and enter “1 ms” in the “Delay Between Polls” field.
6. Click the “OK” button.

Configuration: Connection - Connect with Modbus RTU

1. Click the “Connection... Connect...” menu.
2. From the “Connect Using:” drop-down menu, select “Direct Connection to COMx” where x is the selected COM port.

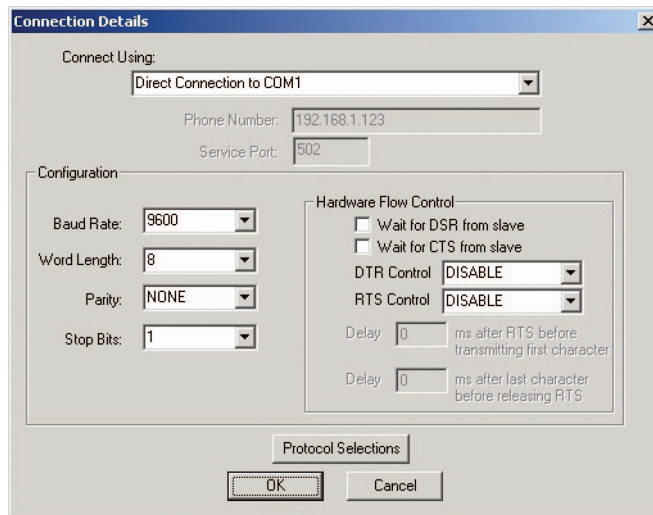

Figure 3-5 “Connection Details” dialog box with direct connection parameters

3. The default settings that appear should be correct for the COM port selected (see Figure 3-5).
4. Click the “Protocol Selections” button and enter “1 ms” in the “Delay Between Polls” field.
5. Click the “OK” button.

ModScan32 running

Modbus Holding Registers are shown in the status window. Use the Modbus Holding Registers chart (see “Modbus® holding registers” on page 83) to determine the value and meaning of these registers.

Example: Register 40258 (Modbus Holding Register 0x0102) shows the first two bits ON. This indicates that the Module is OK (Bit 0) and communications is present (Bit 1).

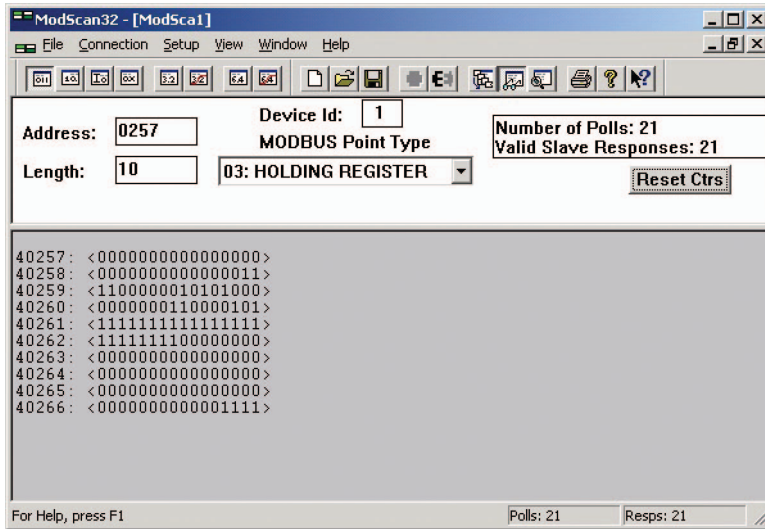

Figure 3-6 ModScan32 status window

If a register is configured as Read/Write, double-click the register in the status window to open the “Write Register” or “Write Coil” dialog box.

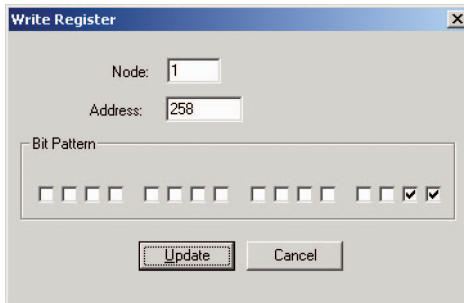

Figure 3-7 “Write Register” dialog box

The “Write Register” dialog box allows selecting the bits within the register.

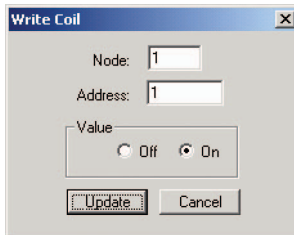

Figure 3-8 “Write Coil” dialog box

The “Write Coil” dialog box allows changing the status of the coil or flag. When the project is running, the coil or flag may change, depending on the flow chart logic.

3.5 Nanoline to Nanoline communication



Nanoline to Nanoline communication requires both controllers are using firmware 1.02.0 or higher. NanoNavigator 4.0.3 or higher is required for configuration.

Communication directly between two Nanoline controllers allows the exchange of up to 32 flags and 32 registers while each controller continues to run independent programs. One controller is set as the master and the other as the slave. Based on the poll rate, the master sends read/write commands to the slave in a specific sequence.

- The master reads flags 90 to 105 from the slave and sets its flags 90 to 105 to match.
- The master writes its flags 106 to 121 to the slave's flags 106 to 121.
- The master writes its registers 106 to 121 to the slave's registers 106 to 121.
- The master reads registers 90 to 105 from the slave and sets its registers 90 to 105 to match.



Flags are written unconditionally, regardless of state (forced on or off).

Data item type is not considered when writing registers between controllers.

A possible application may be at a water plant with a master controller located at the pump station and a slave controller at a tank. The master controller can poll the slave controller to determine tank level. The master can use that information, along with other inputs such as time, to determine if the pumps should be turned on.

3.5.1 Connection

Connection between the two Nanoline controllers is through either an RS-232 or RS-485 crossover cable. The controller must be equipped with the appropriate communication module (NLC-MOD-RS232 or NLC-MOD-RS485) to allow connection of the cable.

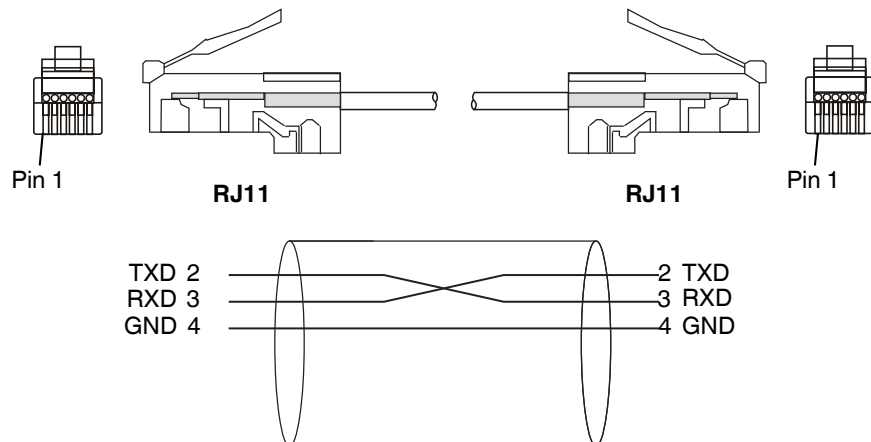

Figure 3-9 RS-232 cable

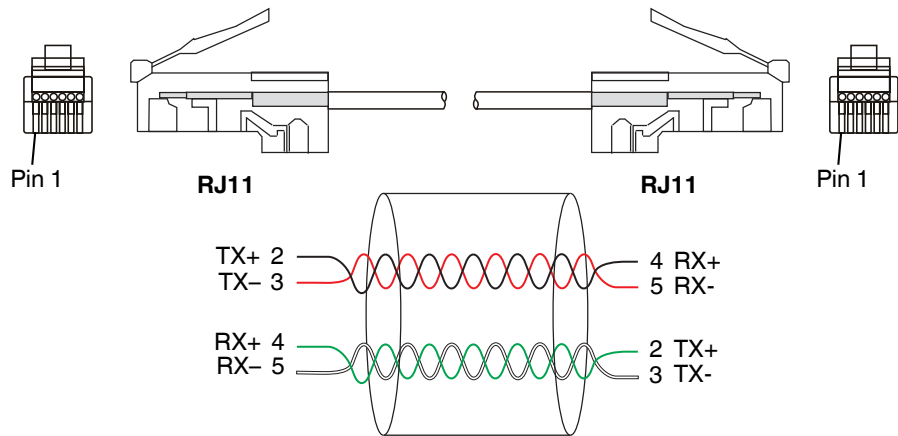

Figure 3-10 RS-485 cable

Cables will need to be field wired.

3.5.2 Configuration

To configure Nanoline to Nanoline communication, one controller must be set as the master. The slave controller node number must be set to 1.

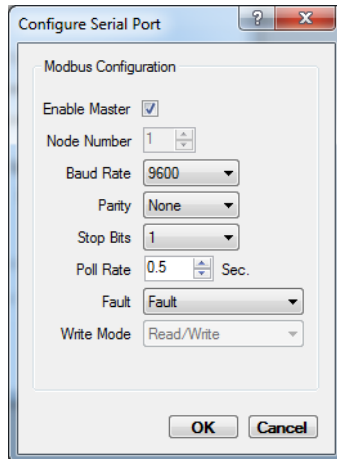

Figure 3-11 “Serial port” dialog box for Nanoline to Nanoline communication

On the Nanoline controller to be set as the master controller:

1. Click the “Nanoline... Configuration” menu to open the “nanoLC Configuration” dialog box. In the “Base Unit” group click the “Configure” button. In the resulting dialog box, choose the appropriate NLC-MOD-RS232 or NLC-MOD-RS485 option module. Click the “Configure” button in the “Communication Option Module” group.
2. Click the “Enable Master” check box in the “Configure Serial Port” dialog box (see Figure 3-11).

3. Set the “Poll Rate” field using the spin arrows. This is selectable in 0.5-second increments. Poll rates should be relative to the transfer rate. For instance, for baud rate of 2400, set the poll rate to 1.0 seconds. For a baud rate of 300, set the poll rate at 8.0 seconds.
4. Click the “OK” button.

On the Nanoline controller to be set as the slave controller:

1. Click the “Nanoline... Configuration” menu to open the “nanoLC Configuration” dialog box. In the “Base Unit” group click the “Configure” button. In the resulting dialog box, select the same option module as the master controller. Click the “Configure” button in the “Communication Option Module” group.
2. Set the “Node Number” field to 1.
3. Click the “OK” button.

The other communication settings can be as desired. However, the baud rate, parity and stop bits must be the same in both the master and slave controllers. In addition, the slave controller node must be set to 1. The Watchdog timeout must be slower than the poll rate set on the master controller.

3.6 Real-time clock



NLC-055... base units include a real-time clock as standard. NLC-050... base units require installation of the RTC option module in Slot 2.

To obtain a real-time clock and other functions, the RTC option module installs in slot 2 (for more information, refer to “Option modules” on page 14).

When installed, the RTC option module provides date and time retention, data retentive memory and project storage. The RTC is updated at the top of every hour. If the RTC option module is not installed, the project is stored on the Nanoline. The date and time can be set using the Operator Panel but will not be retained if power is removed. In addition, any data values are not retained when power is removed.

To set the date and time using nanoNavigator software:

1. Connect to the Nanoline base unit using the desired option module (USB, RS485 or RS232). For more information, refer to the nanoNavigator manual.
2. Click the “nanoLC... Set Date/Time” menu.



This information can be set for a project when not connected to a base unit by clicking the “nanoLC... Configuration...” menu and clicking the “Configuration” button for the base unit. From the “Configure Base Unit” dialog box, select the nLC-MOD-RTC option module in Slot #2 and click the “Configure” button.

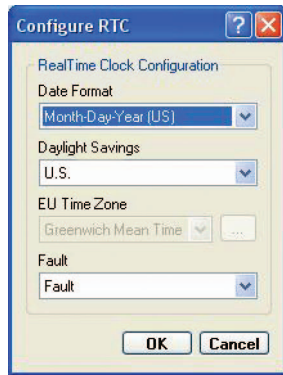

Figure 3-12 "Configure RTC" dialog box

3. Set the options as desired.
 - The "Date Format" drop-down list allows selection of US, European or International date format.
 - The "Daylight Savings" dialog box allows selection of None, US or European configurations. If European is selected, the "EU Time Zone" drop-down box allows selection of the closest time zone from Greenwich Mean Time (GMT) up to 2 hrs.
 - Set the "Fault" drop-down list to either Fault or Warning.

3.6.1 RTC faults

From the “Configure RTC” dialog box, the method for handling RTC faults can be configured. If the Operator Panel is installed, an Error Message appears when a Fault or Warning occurs.

Table 3-4 RTC Error Messages

NLC-MOD-RTC ¹	Fault setting	Error message	Result
Yes	Fault	The Nanoline is stopped because the Real-Time Clock is missing.	Project will not execute ²
Yes	Warning	The following module(s) are required by the project and are either missing or incorrect: Base Option Slot ² . Depending on the fault settings you may still be able to run and monitor this project.	Project will run and Flag 64 is set to ON ²
Yes	Fault	Project Stopped - No RTC	Project will not execute
Yes	Warning	Warning-RTC Battery Low	Project will run and Flag 65 is set to ON ²
Yes	Fault	Invalid RTC Date/Time	Project will not run and Flag 128 is set to ON ³
Yes	Warning	Invalid RTC Date/Time	Project will run and Flag 128 is set to ON ³
No	RTC module is ignored		

¹ If NLC-MOD-RTC is selected in the “Configure Base Unit” dialog box

² NLC-050... only

³ NLC-055... only

Faults are reviewed at startup and every hour. Warning messages can appear at any time. If the battery fails while running, the controller continues to function as long as power is applied. The Error Message appears at the top of the hour.

The Flags related to Error Messages can be read by a Modbus client/master. They can also be read by the program using a Decision block.

4 Commissioning

When power is first applied to the Nanoline, it will start running the program loaded in memory. If input and output devices are connected, they will begin operating as well. To prevent possible equipment damage and inadvertent movement, this section provides a guide to starting, or commissioning, a controller.

4.1 Introduction

Commissioning can be defined as ensuring the designed and installed system functions correctly according to the specification. The intent of this section is to provide a description and overview of the items that must be checked to verify installation.

**CAUTION:**

Do not apply power to the Nanoline or any controller until authorized to do so as outlined in this section. Failure to follow this may result in damage to the control equipment, field sensors, actuators or other network devices and void any warranty.

The start-up and commissioning procedure falls into the following categories:

1. Installation checks
2. Field wiring
3. Power up and functionality
4. Field equipment
5. Control strategy
6. Network setup

It is important to obtain copies of all the design documentation or ensure they are available on site. The documentation should include:

- Project program
- Job specification
- Points chart
- Wiring diagrams
- Panel schematics
- System schematics
- Site plans with sensor locations
- Specialist field equipment details
- Control strategy details/drawings
- Configuration program
- Health and safety assessment

Initial briefing by the Contracts Engineer, Applications Engineer and Electrical Supervisors are essential for a smooth transition through the project.

4.1.1 Installation checks

**CAUTION:**

Do not apply power to the controller or any other devices during this step.

Installation checks should be done by a qualified electrical supervisor in conjunction with the installer to verify the installation is complete according to Section 2 of this manual.

4.1.1.1 Regulations

All installations must abide by the local, state and country regulations. It is the controls supplier who must ensure the installation meets with the standards. Particular interest should be paid to ground/earth of the installation and hardware.

4.1.1.2 Controller mounting

Check the hardware attachment to ensure it is installed as per the instructions. Other items that may be checked include:

- Access to the enclosure
- Display height for proper viewing
- Cable routing
- Trunking and conduit is secure and attached
- Possible Radio Frequency Interface (RFI) or Electromagnetic Interface (EMI)
- Proximity to possible fluid or chemical sources

4.1.1.3 Installation of field equipment

All field equipment must be installed according to the manufacturer's specifications. The equipment varies depending upon the application. Typical types of field equipment are:

- Sensors
- Actuators, valves and dampers
- Variable speed drives
- Airflow sensors

4.1.1.4 Labeling

All wiring should be identified by a label or the wire code as listed in the documentation. If the wiring is not tagged, fault finding at a later stage becomes extremely difficult and time consuming.

Shielded cables, if used, must be grounded at one end only, usually the controller end. The sensor checks take place when the field equipment terminations are checked, in accordance with the manufacturer's recommendations.

All relays, actuators, sensors, and panels should be labeled as listed in the documentation. This reduces time spent locating and identifying field equipment at a later stage.

4.1.1.5 Power wiring

Verify correct installation of line voltage power supply wiring according to all local, state and country regulations. It should be separated from wiring of substantially different voltages, i.e., 115 or 230 V AC should be separated from high voltage wiring of 440 volts and up, and low voltage of 50 volts and less.

Additionally, the line voltage power supply should not be on the same circuit as that powering high-power motors or motor contacts. The starting and stopping of the motor will cause voltage spikes and drops in the voltage to the controller, even if the controller power has gone through a phase change and/or transformer.

Verify that the ground/earth attachment is to a true ground/earth. This should be accomplished via the power supply wiring.

4.1.1.6 End-to-end checks

Each pair of wires for digital, analog and pulse inputs, and digital and analog outputs must be checked for:

- AC/DC Voltages (no voltage should be present)
- Continuity
- Polarity
- Destination (according to the Point Chart)

Correcting crossed wiring, faulty wiring and incorrect destinations can amount to more than 50% of a Commissioning Engineer's time.

In summary, all the above checks are related to the installation of the system and should be checked by a qualified field supervisor.

4.1.2 Field wiring checks



CAUTION:

Do not apply power to the controller or any other devices during this step.

It is assumed at this point that all preceding installation checks have successfully taken place. The power must not be applied to any products during this phase.

4.1.2.1 Power availability

Ensure that the line voltage supply power is available for the controller. If an external power supply is to be used for field supply, it should also be checked for proper operation. This allows the installer time to provide the power if it is not present. However, do not turn the controller on or apply power to any devices.

4.1.2.2 Visual inspection of controller wiring

A visual inspection should take place to ensure the following:

- All wiring is properly terminated.
- Shielded cables are grounded/earthed to the ground/earth terminal strip provided on the Nanoline.
- Wiring is tagged and labeled.
- Wiring is neat and tidy.
- Wiring is installed as described in the point chart.
- Internal power wiring is connected correctly and to the right polarity.

Check for AC voltages

Using a calibrated standard meter, check each terminal with reference to the building ground/earth for any AC voltages (not including power output wiring).

Any abnormal voltage must be eliminated. If there is a voltage present at a check between the return terminals and input/output terminals, it must be less than 0.5 volts.

If a voltage is present on any return terminal, it will be present on all return terminals, as these are common. The same applies to the field supply terminals. To identify the faulty wiring, disconnect all the terminals, thus isolating the problem to a specific input/output cable.

While the installer is identifying and correcting any faults, the terminals for the associated input/output should remain disconnected.

Check for DC voltages

Check each terminal with reference to the building ground/earth for any DC voltages (not including power output wiring) in exactly the same manner as previously described for AC voltages.

Check connections for short circuits to ground/earth

Using a calibrated standard meter, check each terminal with reference to building ground/earth (not including power output wiring). While it is acceptable for the return terminal to be connected to ground/earth, the input and output terminals and field supply terminals should be free of short circuits to ground/earth.

The return is sometimes connected to ground/earth via field sensors or actuators. This information is available from the points chart and field connection details and is acceptable. The return terminals are common on the controller. Therefore, if a ground/earth is present on one input/output, it appears on all return terminals.



CAUTION:

Connecting the return through the field device should be avoided if possible. If unavoidable, connect the field device as close to the controller as possible.

If a ground/earth is present on the field supply terminals, disconnect all the terminals. These terminals are common to the whole module. Once removed, the faulty wiring can be identified, and the problem repaired.

Input and output terminals are isolated from one another, and any short circuits to ground/earth appear on the specific terminal only, with the exception of digital inputs. If the field contact is closed, it must be checked independently. This can be achieved by disconnecting the appropriate terminals and checking for a short circuit between the input and return terminals.

While the installer is locating any faults, the terminals for the associated input/output should remain disconnected until corrected and rechecked.

Check for short circuits between terminals

The following checks should be made for any short circuits.

1. Return and field supply terminals

Select any return and any field supply terminal and test for a short circuit. Should a short circuit be present, all the terminals will need to be disconnected and re-tested individually because both the return and field supplies may be common elsewhere.

2. Return and input/output terminals

Select any return terminal and test for short circuit between the return terminal and each input/output terminal. If a digital input is closed, it must be tested independently by forcing a change of state of the relay or sensor.

3. Field supply and input/output terminals

Select any field supply terminal and test for a short circuit between the field supply and each input/output terminal. Digital input may need to be checked as described previously.

Any faulty cable should be disconnected and investigated by the installer and not installed until rechecked.

4. Network cables

Test the network cables to the same as 1 - 4 above. However, the network should be unplugged at this stage as installations are sometimes phased, and the network should be commissioned as one exercise.

5. Externally powered and polarity-sensitive field devices

All field devices should be checked to ensure they are installed according to the manufacturer's recommendations.

- Externally powered devices (actuators, pressure sensors, etc.) – If power is applied to field equipment, disconnect the wiring to the controller hardware. Once commissioned and the output signals checked, it may then be reconnected to the controller and checked for polarity.
- Polarity-sensitive devices (actuators, transducers, etc.) – Checks should be made where polarity-sensitive field equipment is used to make sure the 0 volt (Return) of that equipment is connected to the Return terminal of the input or output.

6. Controller link settings

All links (jumper) on the I/O channels should be positioned to suit the type of field signal to be received or controlled.

4.1.3 Power up and functionality checks

It is assumed at this point that all preceding installation checks have successfully taken place.

4.1.3.1 Turning on the power

The power can now be safely applied to the controller.

Once the power has been applied, the PWR LED should illuminate, indicating proper power up. If there is a valid project present on the Nanoline and there are no warnings or errors, the RUN LED will also illuminate. Refer to "LED indicators" on page 33 for additional information on LEDs.

If there are any abnormal conditions from any of the above, disconnect the field wiring. Review and correct any conditions found until the LED operates correctly.

4.1.3.2 Operator Panel

Once the power is applied, the optional Operator Panel should illuminate. If a program is loaded, a programmed startup screen will appear. If a program is not loaded, a status page will appear.

4.1.3.3 Connecting to a computer

Connect to a computer through the installed base unit option module in Slot #1. Connection to the PC will be through either an RS-232, RS-485, or USB port. With the nanoNavigator configuration software installed on the PC, programs can be downloaded, uploaded, or monitored. Refer to Section 3 of this manual and the nanoNavigator User Manual for additional information regarding computer connections.

4.1.4 Field equipment commissioning

It is assumed at this stage that all the installation, controller hardware and wiring checks are complete and corrected where faulty. This part of the commissioning procedure is related to verifying that the field input and output conditions witnessed on the controller are correct and accurate.

All the preceding checks have been made to ensure the hardware and wiring are securely attached and installed correctly. The system is now ready to be checked for the relationship between the field hardware and application software designed off site.

4.1.4.1 Starting the Nanoline controller

The Nanoline controller begins operating upon power-up. To stop processing of a loaded control application, press the <Shift> and <OK> keys on the Operator Panel and select Run/Stop from the System menu.



DANGER:

Before starting any controller, be sure the output wiring to any field devices is disconnected to prevent start-up of field devices.

Until the control application is loaded, it remains as an unconfigured controller. This is apparent only on the first use of the Nanoline. After a project is loaded, the Nanoline will always contain a project.

4.1.4.2 Loading a project into the Nanoline

It is important to ensure that the output wiring to any field device is disconnected before loading the system as the software may start in an unknown state. To ensure the output wiring is not connected, disconnect the output channels at the controller. After the software is loaded, monitor the I/O using nanoNavigator and ensure outputs are not being turned on. Stop the control application from running using either the Operator Panel or through nanoNavigator. Then the outputs can be reattached.

Once the software is loaded, a quick visual check should be made to ensure the right project is loaded. This can be achieved by viewing the I/O and comparing it with the point chart or by verifying the configuration within nanoNavigator to the point chart.

It is worthwhile at this point to set the correct date and time on the controller. If an RTC is installed, the date and time is retained upon power down and restart. Refer to “Real-time clock” on page 47 for additional information.

4.1.4.3 Addressing the inputs

Ensure the Nanoline is stopped. From the Operator Panel:

- Press the <Shift> and <OK> keys on the Operator Panel.
- Press the <1> key to stop processing.

Or from nanoNavigator:

- Click the “Nanoline... Stop Nanoline!” menu to stop processing.
- Click the “Nanoline... Disconnect” menu to release the connection to the Nanoline.

The physical location of each input (where the wires are connected) must be verified to ensure the physical input is associated with the correct software address. If channels are not available, check the project configuration in nanoNavigator to ensure proper base unit and expansion module selections (see Figure 4-2).

- Click the “Nanoline... Configuration” menu to open the “nanoLC Configuration” dialog box.

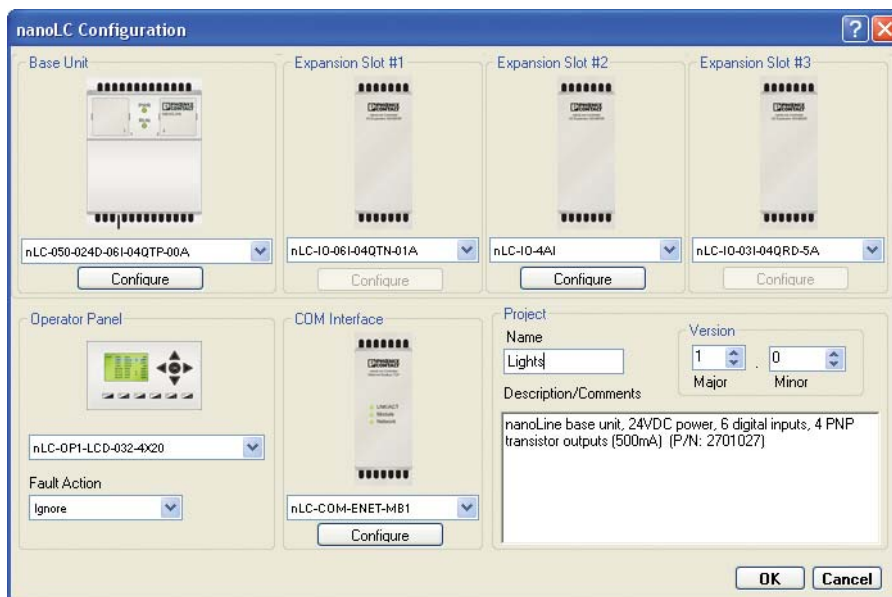

Figure 4-1 nanoNavigator 2 “Nanoline Configuration” dialog box showing configuration of NLC-050... system

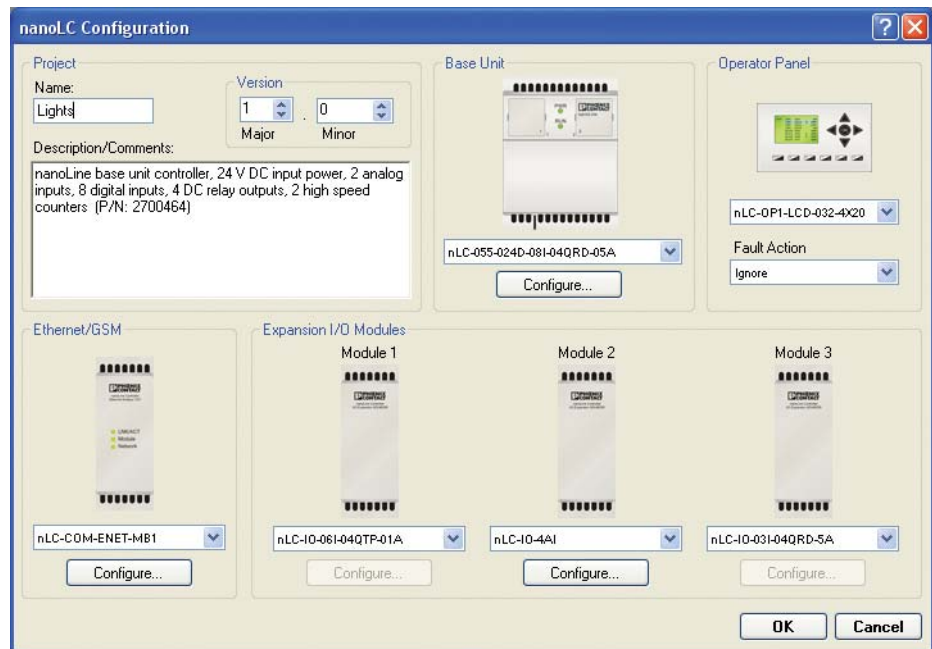

Figure 4-2 nanoNavigator 3 “Nanoline Configuration” dialog box showing configuration of NLC-055... system

- Ensure correct selection of the base unit and I/O expansion modules in each drop-down menu.

The inputs should be turned on at their physical location (one at a time) and checked within nanoNavigator to assure proper setup and operation.

4.1.4.4 Addressing the outputs



WARNING:

Ensure all personnel are clear of controlled devices. Outputs that are inadvertently energized can cause sudden movement of connected devices.

Before checking the output channels, ensure the Nanoline is stopped. From the Operator Panel:

- Press the <Shift> and <OK> keys on the Operator Panel.
- Press the <1> key to stop processing.

Or from nanoNavigator:

- Click the “nanoLC... Stop nanoLC!” menu to stop processing.
- Click the “nanoLC... Disconnect” menu to release the connection to the Nanoline.

The physical location of each output (where the wires will be connected) must be verified to ensure the physical output is associated with the correct software address. If channels are not available, check the project configuration in nanoNavigator to ensure proper base unit and expansion module selections (see Figure 4-2).

- Click the “nanoLC... Configuration” menu to open the “nanoLC Configuration” dialog box.
- Ensure correct selection of the base unit and I/O expansion modules in each drop-down menu.

With outputs still disconnected, use a volt meter to check if voltage is present at the appropriate terminals. The outputs can be forced ON or OFF using either the Operator Panel or nanoNavigator. From the Operator Panel:

- Press the <Shift> and <OK> keys on the Operator Panel.
- Press the <0> key to access the data items.
- Press the <1> key to access the outputs.
- Use the ▲ or ▼ key to scroll through the list. When the desired output is highlighted, press the <OK> key.
- Press the <1> key to force the output ON. Press the <2> key to force the output OFF.
- When finished, highlight the output and press the <OK> key. Press the <0> key to unforce the output.



The output will remain in “Force” mode until “Unforce” is selected. This will result in the project not running properly.

From nanoNavigator:

- Click the “nanoLC... Monitor” menu to open the “nanoLC - Monitor” screen.
- Right-click the row with the desired output, and then click either “Force On” or “Force Off” from the context-sensitive menu.
- When finished, right-click the desired output, and then click “Unforce” in the context-sensitive menu.



The output will remain in “Force” mode until “Unforce” is selected. This will result in the project not running properly.

Alternately, nanoNavigator provides “Turn On” and “Turn Off” commands. When the “Turn On” and “Turn Off” commands are used, the project logic overrides the “manually set” output status when the project is started.

4.1.4.5 Memory addresses

Memory addresses can be described as place holders for data. These addresses reside within the Nanoline as registers and flags. Data can be stored in registers in many different formats. Flags store data as either OFF or ON. Refer to the nanoNavigator User Manual for additional information on registers and flags.

Using nanoNavigator, simulate the project and verify that registers and flags are performing as expected.

- Click the “nanoLC... Simulate Project” menu.
- Click the “Start” button to begin the project simulation.

4.1.4.6 Checking the analog field points

This stage is required to confirm the analog field points are reading the correct conditions accurately.

The order in which the following point types are commissioned is not important, but this exercise must be done accurately to allow the controls to function correctly.

The speed with which this stage can be achieved depends upon the accuracy of the end-to-end checks performed during the installation checks.



The field equipment cannot be checked and calibrated properly unless it is installed in the proper location and any commissioning required by the sensor/actuator has taken place.

Analog inputs

Each analog input must be checked for accuracy.

Two checks must be made:

- Destination – Once a value is observed at the device, a corresponding change must be observed (regardless of accuracy) at the Nanoline to ensure the sensor is connected to the right channel.
- Calibration – All the range and offsets or tables for the sensor are set in the software during the application stage. However, due to line losses, the offset may require adjustment.

For example, the use of a digital thermometer allows the checking of temperature sensors. The temperature should be taken as close to the sensor as possible and checked for accuracy with the reading displayed on the Nanoline. If there is a difference in readings, a +/- change to the offset can be made to compensate.

Depending upon the input type, measurements of voltage, current, resistance, humidity, speed, pressure, etc., may need to be checked in a similar fashion.

Where field devices are used, it is normal to provide the controller with a variable voltage or current signal between 0-5 V DC, 0-10 V DC, 0-20 mA or 4-20 mA. If the device is commissioned independently, the signal can be measured and compared with the signal range (e.g., 0-1000 Pascals) and a calibration check made against this value witnessed at the controller.

4.1.4.7 Control strategy

After all inputs and outputs are functioning correctly and accurately, the control strategy can be commissioned.

The basis of this stage relies upon the skill of the Application Engineer interpreting the customer/consultant's specification correctly.

It is the Commissioning Engineer's job to verify that the application meets the specification. Therefore, an intimate knowledge of the specification is required by the Commissioning Engineer. Alterations to parameters that are site-dependent must be entered to maximize the efficiency of the controls employed.

Features, such as automatic mode, manual mode, diagnostics, looping in controls, destinations of blocks, order of execution of flow charts, messages and data items, need to be verified at this time.

Every step of the application must be checked to ensure the response is correct as designed and specified. This part of the commissioning requires knowledge in both controls and controller logic.

The commissioning of the network falls into the following stages.

- Installation
- Wiring and hardware
- Program application execution

Ethernet installation checks

The controller must be fully operational and the network cable installed. Shielded cable must be grounded/earthed at one point per leg.

Cable routing must be kept separate from any AC power wiring. The route of the cable should be verified against the network layout drawing and all input and output destinations tagged on the cables at each node.

Ethernet wiring and hardware checks

It is assumed at this stage that the installed cable has been proved correct from point to point.

1. Check for AC voltages
Using a calibrated standard meter, each cable, including the shield, should be checked with reference to building ground/earth for any AC voltages. Any AC voltages present must be eliminated.
2. Check for DC voltages
Using a calibrated standard meter, each cable, including the shield, should be checked with reference to building ground/earth for any DC voltages. Any DC voltages present must be eliminated.
3. Check for short circuit to ground/earth
Using a calibrated standard meter and with reference to building ground/earth, each cable, including the shield, should be checked for short circuits. Any short circuits must be removed.
4. Check for short circuits between wires and shield
A check should be made for any short circuits between each wire and screen to ensure that no short circuits exist. Any short circuits must be removed.
When the above checks are completed and correct, the network terminals can be connected.
5. Network addressing
Network addressing is located within nanoNavigator in the configuration section. There the network IP Address can be set using either BootP, DHCP or a static IP Address.
 - When using BootP IP Addressing, use the IPAssign program available from Phoenix Contact as a free BootP server IP assignment tool. The IP address will be assigned after a download is performed to the Nanoline and IPAssign is run.
 - When using DHCP IP Addressing, the Ethernet module will get its IP assigned from the network server after a download to the Nanoline.
 - When using a static IP Address, be sure to enter the Subnet Mask as well. IP Address will be assigned after a download to the Nanoline.

Ethernet data transmission

This stage is to prove communication on transmission of remote data. Use ModScan32 software to check the network inputs, outputs and holding register communication. Refer to “Modbus communication” on page 41 for additional information.

5 Operator Panel usage

To provide an interface for the user, two optional Operator Panels (NLC-OP...) are available for the Nanoline controller.

- The NLC-OP1-LCD-032-4X20 Operator Panel uses an 8-line, 21-character Liquid Crystal Display (LCD), four navigation keys, an <OK> or select key, a shift key and five data entry keys.
- The NLC-OP2-LCD-076-4X20 Operator Panel uses a 4-line, 21-character Liquid Crystal Display (LCD), four navigation keys, an <OK> or select key, a menu key and numeric data entry keys 0 through 9.

When a user interface is created within nanoNavigator, the navigational keys allow selection of the various screens and fields within the screens.

5.1 Description

While programming of the Nanoline controller is accomplished through the nanoNavigator software, the Operator Panel provides the ability to monitor the control, enter values and troubleshoot the project.

During normal operation (Run mode), programmer-defined screens are displayed for the operator. These screens are created using nanoNavigator. Navigation between the screens can be automatic, selected by the flow chart, or manual, depending upon which keys are pressed by the operator. If programmed, data can be entered at the appropriate screen using the number keys. nanoNavigator, the programming software, allows the programmer to enter messages using the first 20 characters in rows 2 through 5 for display within the control application.



This manual focuses on the use of the Monitor and View functions of the Operator Panel. The functionality of the screens as displayed within the control application is controlled by the programmer.

In Monitor mode the Operator Panel displays specific data points. Data points can be forced either ON or OFF. System information is also available within this mode. Monitor mode also allows start and stop of the program and displays system information.

5.2 Key usage for NLC-OP1-LCD-032-4X20

There are 15 user input keys on the Nanoline for user input.

- Four arrow keys allow moving through menus and can be used in the control application.
- The <OK> key provides several functions. One is to select a field or function when debugging. Another is to accept a user input in the control application.
- The numbered keys along the bottom are for menu selection and data entry when debugging or within the control application. Numbers 0 through 4 can be entered with a single key press. Numbers 5 through 9 can be entered by holding the <Shift> key and pressing the desired number.



When used within a Decision block, pressing a key, either <OK>, an arrow, or number key, is considered a digital ON.

5.2.1 Special key combinations

<Shift> + <OK>

When in Run mode, pressing the <Shift> and <OK> keys together places the controller in Monitor mode and displays the System menu.

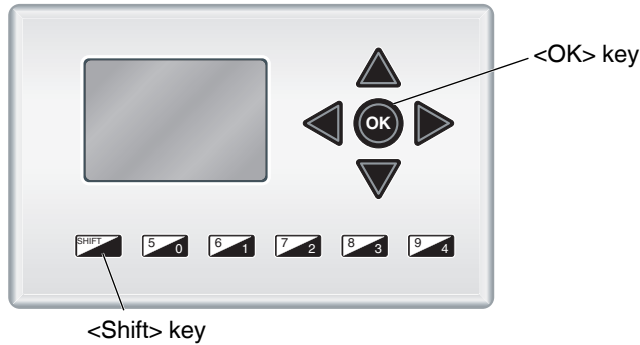

Figure 5-1 <Shift> and <OK> keys

<Shift> + ▲

When in the Monitor mode, pressing the <Shift> and ▲ keys together returns the user to the previous menu. Continuous pressing of these keys will eventually return the user to the control application screen or main selection screen, if a user-defined screen is not configured.



Not all screens display "SF ▲" at the bottom of the screen. However, pressing the <Shift> and ▲ keys always displays the previous menu, even when not displayed at the bottom.

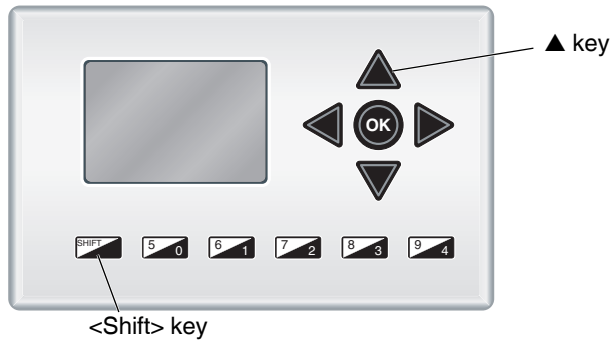

Figure 5-2 <Shift> and ▲ keys

5.3 Key usage for NLC-OP2-LCD-076-4X20

The user-input keys on the Nanoline are:

- Four arrow keys allow moving through menus and can be used in the control application.
- The <OK> key provides several functions. One is to select a field or function when debugging. Another is to accept a user input in the control application.
- The numbered keys are for menu selection and data entry when debugging or within the control application.
- The menu key exits Run mode and displays the System menu.
- The menu back key navigates the user up one level or exits the System menu.



When used within a Decision block, pressing a key, either <OK>, an arrow, or number key, is considered a digital ON.

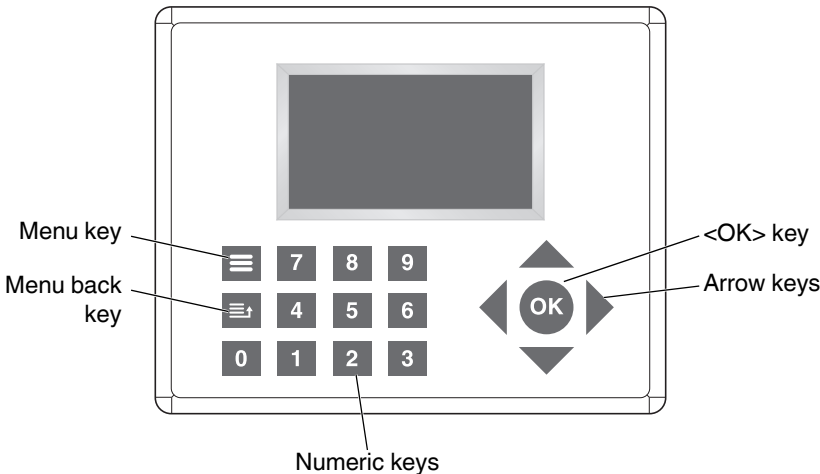

Figure 5-3 NLC-OP2-LCD-076-4X20

5.3.1 Special key combinations

Menu + <1>

When in Run mode, press the Menu and <1> keys together to adjust the color of the screen. Press the 1, 2, or 3 key to select the corresponding background color. Press the <OK> key to save the settings. Press the <Menu back> key to cancel the changes.



Figure 5-4 Background color

Menu + <2>

When in Run mode, press the Menu and <2> keys together to set the timeout value of the screen. Use the numeric keys to enter a value between 0 and 99 minutes, where 0 is always on. Press the <OK> key to save the settings. Press the <Menu back> key to cancel the changes.

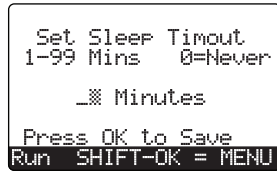

Figure 5-5 Timeout settings

Menu + <3>

When in Run mode, press the Menu and <3> keys together to configure the serial settings of the Operator Panel. Press the 1 key to configure the settings or press the 2 key to reset the device to the factory default settings.



When configuring the port settings, use the ▲ or ▼ keys to navigate between the fields and use the ◀ or ▶ keys to select from the available menu choices.

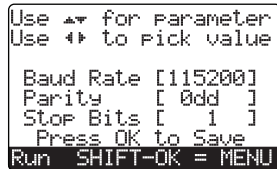

Figure 5-6 Serial port settings

The factory default settings are:

Baud rate	115200
Parity	Odd
Stop Bits	1

Press the <OK> key to save the settings. Press the <Menu back> key to cancel the changes.

5.4 Run mode

When power is first applied to the Nanoline, there are three possible screens that appear.

5.4.1 Project loaded and message sent

If a project resides on the Nanoline that was previously downloaded, upon power-up the display can look like Figure 5-7.

```

Sprinkler Sys Main
Set Zones      = 0
Set Times     = 1
Start System  = OK

Run SHIFT-OK = MENU

```

Figure 5-7 Opening screen in Run mode

This screen is a user-defined screen, created in nanoNavigator and selected by the programmer as the startup screen, that is sent to the Nanoline display when the application is running.

5.4.2 Project loaded and no message sent

If there is a project residing on the Nanoline that was previously downloaded but has not been sent to the display screen because the flowchart has not sent it yet, the display can look like Figure 5-8.

```

Runnins - Proj OK
Mon 7/30/08 13:45:23
I 111000
O 0000

SHIFT-OK = MENU

```

Figure 5-8 Project running, no display, and no expansion modules

This screen shows that the project is running but the flow chart has not sent the user-defined screen to the display.

The date and time are shown under the heading.

The I/O indicators show the I/O that is available within the Nanoline and the expansion modules. If there was one expansion module attached, the display would look like Figure 5-9.

```

Runnins - Proj OK
Mon 7/30/08 13:43:23
I 111000
 100000
O 0000
 0000

SHIFT-OK = MENU

```

Figure 5-9 Project running, no display, and one expansion module

If there were three expansion modules attached, the display would look like Figure 5-10.

```
Running - Proj OK
Mon 7/30/08 13:43:23
I 111000
100000000000000000
O 0000
000000000000
SHIFT-OK = MENU
```

Figure 5-10 Project running, no display, and three expansion modules

If the project is stopped, the display would look like Figure 5-11.

```
Stopped - Proj OK
Mon 7/30/08 13:43:23
I 111000
100000000000000000
O 0000
000000000000
SHIFT-OK = MENU
```

Figure 5-11 Project stopped

5.4.3 No project loaded

The third possible initial display screen is no project loaded onto the Nanoline. Upon power-up, the screen will look like Figure 5-12.

<pre>Stopped - No Proj Mon 7/30/08 13:43:17 I 111000 O 0000 SHIFT-OK = MENU</pre>	<pre>Stopped - No Proj Mon 7/30/08 13:43:23 I 111000 100000000000000000 O 0000 000000000000 SHIFT-OK = MENU</pre>
---	---

Figure 5-12 Project not running, no display

Figure 5-12 shows a Nanoline base unit only on the left and a Nanoline with three expansion modules on the right.

5.5 Monitor mode

Monitor mode is used for troubleshooting and verifying operation of a control application. At the top level of Monitor mode, the System menu allows selection of the various functions. From any user screen, the System menu can be accessed by pressing the <Shift> and <OK> keys simultaneously.

```

rSelect      Status
0 Monitor
1 Run/Stop -
  Password -
  Proj -
4 Setup -

SF ▲ Exit

```

Figure 5-13 System menu without application loaded



A prompt appears for a password if the program is configured to require a password. Refer to “Password” on page 79 for additional information.

If a project is running and Monitor mode is entered, the System menu displays status information for the application.

```

rSelect      Status
0 Monitor
1 Run/Stop - Stopped
  Password - Not Set
  Proj - Sprinkler Sy
4 Setup - PN 2701027

SF ▲ Exit

```

Figure 5-14 System menu with application loaded

Status is displayed indicating if the project is stopped or running, if a password is active, the name of the project, system information, and if a memory module is present.



The password, project name and setup information are entered in nanoNavigator by the programmer.

The status for each item is displayed in reverse text (light on dark) next to the associated item.

5.6 System menu

From the System menu, press the <0> key to access the “Monitor” menu. The “Monitor” menu allows the user to view data items on a point-by-point basis or view the flow charts used to program the control application.

5.6.1 Monitor Data Items

Press the <0> key to access the “Monitor Data Items” menu.

```

Select
0 I(INPUT)
1 Q(OUTPUT)
2 F(FLAG)
3 TC(TIMER/COUNTER)
4 R(REGISTER)

```

Figure 5-15 “Monitor Data Items” menu

A list of the different data types is displayed

- Inputs - A digital (single bit) on or off signal coming into the Nanoline from an externally wired device.
- Outputs - A digital (single bit) on or off signal leaving the Nanoline to an externally wired device.



Outputs are signified as Q to differentiate them from 0 (zero).

- Flags - An internal (single bit) on or off signal within the Nanoline.
- Timers/Counters
 - Timers: Used to indicate a span of time in the format HH:MM:SS or x.xxx seconds.
 - Counters: Used to start, reset, restart, increment, and decrement a 32-bit integer value.
- Registers - An internal item to store an integer, date, time of day, day of week, hours-minutes-seconds, or seconds.

5.6.1.1 Inputs

From the “Monitor Data Items” menu, select 0 to display all the inputs available in the Nanoline, where they reside and their status.

```

INPUT CPU I00 ON
CPU I01 f OFF
CPU I02 OFF
CPU I03 ON
CPU I04 f OFF
CPU I05 OFF
E100 I06 OFF
E101 I07 OFF

```

Figure 5-16 Input List

A list of the physical inputs appears. If more than 8 inputs are available, use the ▲ or ▼ key to scroll through the list.

- The first column shows the physical location of the input channel. For example, Figure 5-16 shows inputs I0 through I5 are in the Nanoline base (CPU), and inputs I06 and I07 are on the first expansion module (E1--).

- The second column displays the input channel number.
- The “f” indication means the input is forced to a state of ON or OFF.
- The third column indicates the current status of the input (OFF or ON).

To aid in debugging, inputs can be forced ON or OFF.

To force an input, use the ▲ or ▼ key to highlight the desired input. Press the <OK> key to display the available force options.

```

rSelect          I00
0 Unforce
1 Force ON
2 Force OFF

```

Figure 5-17 Force input options

Press the number key that corresponds to Unforce, Force ON, or Force OFF to select the desired state.



Only the available options in the current state are displayed. For example, if the input state is Force ON, only Unforce and Force OFF are displayed when the input force screen is accessed again.



When a force is removed, the status remains in the forced state unless changed by a physical input.

5.6.1.2 Outputs

From the “Monitor Data Items” menu, select 1 to display all the outputs available in the Nanoline, where they reside and their status.

```

OUT  CPU  Q00  ON
      CPU  Q01r f OFF
      CPU  Q02r  OFF
      CPU  Q03r  ON
      E100 Q04r  OFF
      E101 Q05  f OFF
      E102 Q06  f OFF
      E103 Q07  OFF

```

Figure 5-18 Output List

A list of physical outputs appears. If more than 8 outputs are available, use the ▲ or ▼ key to scroll through the list.



Outputs are signified as Q to differentiate them from 0 (zero).

- The first column shows the physical location of the output channel. For example, Figure 5-18 shows outputs Q0 through Q3 are in the Nanoline base (CPU) and outputs Q4 through Q7 are on the first expansion module (E1--).
- The second column displays the output channel number.
- The “r” indication means the output is retentive (saved when power to the Nanoline is removed).
- The “f” indication means the output is forced to a state of ON or OFF.
- The third column indicates the current status of the output (OFF or ON).

To aid in debugging, outputs can be forced ON or OFF.

Use the ▲ or ▼ key to highlight the desired output. Press the <OK> key to display the available force options.

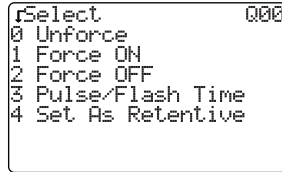

Figure 5-19 Force output options

Press the number key that corresponds to Unforce, Force ON, or Force OFF to select the desired state.



Only the available options in the current state are displayed. For example, if the output state is Force OFF, only Unforce and Force ON are displayed when the output force screen is accessed again.



When a force is removed, the status remains in the forced state unless changed by the control application logic.

Two additional options are available for configuration from the force output screen.

Pulse/Flash Time - An existing pulse or flash time can be modified for a specified output. A pulse allows an output to be ON for a specified time and then returns to OFF. A flash time cycles the output ON and OFF at the specified frequency.



The pulse/flash time may be configured for the data item. However, the control must call the pulse/flash for it to be visible. For example, an output may cause a light to flash under one condition and illuminate steady-state under another condition. In this case, the data item has a flash time defined, but it is only called under one condition.

The format of the output value defaults to the value previously selected in nanoNavigator in the format. The format possibilities are:

HH:MM:SS	xx:xx:xx
Seconds	x.xxx

Press 3 to enter an Output/Flash value, and press the <OK> key.



Figure 5-20 Entering an Output/Flash Time

Set as Retentive – When an output is set as retentive, it stores the current state in memory in the event of a power failure. When power is restored, the stored state is recalled and the output placed in that state.

To set the output as a retentive item, from the output list screen, use the ▲ or ▼ key to highlight the desired output. Press the <OK> key, and then press the <4> key to set the output as retentive.

```

rSelect          000
0 Unforce
1 Force ON
2 Force OFF
3 Pulse/Flash Time
4 Set As Retentive

```

Figure 5-21 Setting an output as retentive

To set the output as non-retentive, from the output list screen, use the ▲ or ▼ key to highlight the desired output. Press the <OK> key, and then press the <4> key to set the output as non-retentive.

```

rSelect          000
0 Unforce
1 Force ON
2 Force OFF
3 Pulse/Flash Time
4 Remove Retentive

```

Figure 5-22 Removing the retentive setting

5.6.1.3 Flags

From the “Monitor Data Items” menu, select 2 to display all the flags available in the Nanoline and the status of each one.

```

FLAG  F000r  ON
      F001r f  ON
      F002r  OFF
      F003r  ON
      F004r f  ON
      F005 f  OFF
      F006  OFF
      F007  OFF

```

Figure 5-23 Flag List

A list of flags appears. Use the ▲ or ▼ key to scroll through the list.

- The first column indicates the number of each flag.
- The “r” indication means the flag is retentive (saved when power to the Nanoline is removed).
- The “f” indication means the flag is forced to a state of ON or OFF.
- The third column indicates the current status of the flag (OFF or ON).

To aid in debugging, flags can be forced ON or OFF.

Use the ▲ or ▼ key to highlight the desired flag. Press the <OK> key to display the available force options.

```
rSelect          F000
0 Unforce
1 Force ON
2 Force OFF

4 Set As Retentive
```

Figure 5-24 Force flag options

Press the number key that corresponds to Unforce, Force ON, or Force OFF to select the desired state.



Only the available options in the current state are displayed. For example, if the flag state is Force OFF, only Unforce and Force ON are displayed when the flag force screen is accessed again.



When a force is removed, the status remains in the forced state unless changed by the control application logic.

In addition to being able to be forced, flags can be configured as retentive.

Set as Retentive – When a flag is set as retentive, it stores the current state in memory in the event of a power failure. When power is restored, the stored state is recalled, and the flag is placed in that state.

To set the flag as retentive, from the flag list screen, use the ▲ or ▼ key to highlight the desired flag. Press the <OK> key, and then press the <4> key to set the flag as retentive.

```
rSelect          F000
0 Unforce
1 Force ON
2 Force OFF

4 Set As Retentive
```

Figure 5-25 Setting a flag as retentive

To set the flag as non-retentive, from the flag list screen, use the ▲ or ▼ key to highlight the desired flag. Press the <OK> key, and then press the <4> key to set the flag as non-retentive.

```
rSelect          F000
0 Unforce
1 Force ON
2 Force OFF

4 Remove Retentive
```

Figure 5-26 Removing the retentive setting

5.6.1.4 Timers and counters

From the “Monitor Data Items” menu, select 3 to display all the timers available in the Nanoline and the status of each one.

```
TMR/ TC00r C 78.000
CNTR P 999.000
      TC01r C 0000.000
      P 100.000
      TC02r C 00000000
      P 00000000
      TC03r C 00:00:00
      P 00:00:00
```

Figure 5-27 Timer/counter list

A list of timer/counters appears. Use the ▲ or ▼ key to scroll through the list.

- The first column shows the number of each timer/counter. Each timer/counter uses two rows to display the information.
- The “r” indication means the timer/counter is retentive (saved when power to the Nanoline is removed).
- The second column indicates the row is displaying a current (C) value or a preset (P) value.
- The third column indicates the value of either the current or preset value.

Two options are available for modifying a Timer/Counter.

Modifying the preset value – Use the ▲ or ▼ key to highlight the desired timer/counter. Press the <OK> key to display the available options.

```
rSelect TC00
3 Modify Preset Value
4 Remove Retentive
```

Figure 5-28 Timer/counter modification options

Press the <3> key to access the preset value modification field.

Use the ▲ or ▼ key to highlight the desired timer/counter, and then press the <OK> key.

```
MODIFY TC00
Enter New Value:
----.---
OK ?
```

Figure 5-29 Entering a timer/counter preset value

The format of the timer/counter value defaults to the value previously selected in nanoNavigator. The format possibilities are:

Counter	xxxxxx
HH:MM:SS	xx:xx:xx
Seconds	x.xxx

Set as Retentive – When a timer/counter is set as retentive, it stores the current (C) value of the counter in memory in the event of a power failure. When power is restored, the stored value is recalled, and the counter begins from that value.

To set the timer/counter as retentive, from the timer/counter list screen, use the ▲ or ▼ key to highlight the desired timer/counter. Press the <OK> key, and then press the <4> key to set the timer/counter as retentive.

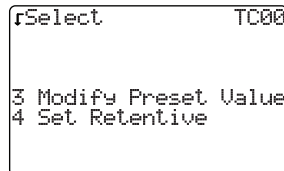

Figure 5-30 Setting a timer/counter as retentive

To set the timer/counter as non-retentive, from the timer/counter list screen, use the ▲ or ▼ key to highlight the desired timer/counter. Press the <OK> key, and then press the <4> key to set the timer/counter as non-retentive.

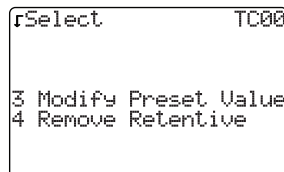

Figure 5-31 Removing the retentive setting

5.6.1.5 Register

From the “Monitor Data Items” menu, select 4 to display all the registers available in the Nanoline and the status of each.

REGS	Register	Value
	R00r	18000000
	R01	00000000
	R02r	00:00:00
	R03r	0000.000
	R04	00/00/00
	R05	00000000
	R06r	MON
	R07	35000

Figure 5-32 Register List

A list of registers appears. Use the ▲ or ▼ key to scroll through the list.

- The first column displays the number of the register number.
- The “r” indication means the register is retentive (saved when power to the Nanoline is removed).
- The second column indicates the current value stored in the register.

Registers allow data to be stored in the following formats:

Integer	xxx
Date	xx/xx/xx
Time of Day	xx:xx:xx
Day of Week	MON, TUE, etc.
Hours, Minutes, Seconds	xx:xx:xx
Seconds	x.xxx

To modify a register value, use the ▲ or ▼ key to highlight the desired register and press the <OK> key. Press the <3> key to access the modification screen.



Figure 5-33 Entering a register value

When set as retentive, the register value is stored in memory in the event of a power failure. When power is restored, the stored value is recalled, and the control application uses the stored value.

To set a register as retentive, from the register list screen, use the ▲ or ▼ key to highlight the desired register. Press the <OK> key, and then press the <4> key to set the register as retentive.

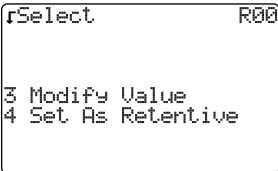

Figure 5-34 Setting a register as retentive

To set the register as non-retentive, from the register list screen, use the ▲ or ▼ key to highlight the desired register. Press the <OK> key, and then press the <4> key to set the register as non-retentive.

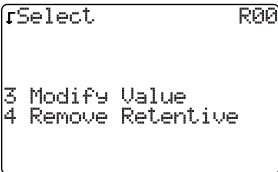

Figure 5-35 Removing the retentive setting

5.6.2 Run/Stop menu

Normally, a control program begins operating as soon as power is applied to the Nanoline or a program is transferred from nanoNavigator or a memory module. Controlling execution of the program can be accomplished using the Operator Panel.



WARNING:

Ensure all personnel in the operating area are clear of any machinery controlled by the Nanoline before starting and stopping program execution.

5.6.2.1 Stopping execution

From the System menu, press the <1> key to stop the control program from executing the program. From the screen that appears, press the <0> key to stop execution. The program will stop running and all flow charts will be turned off.



Figure 5-36 Stopping program execution

If choosing not to stop the program, press the <Shift> and ▲ keys to return to the System menu.

5.6.2.2 Starting the program

From the System menu, press the <1> key. The control program will immediately begin executing commands from the operating block at which it was stopped.



WARNING:

Execution begins immediately. Unlike stopping execution, no additional screens are provided.

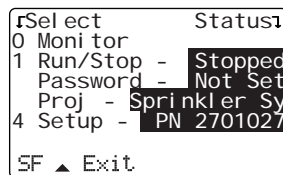

Figure 5-37 Press 1 to start program execution

5.6.3 Password

To prevent changes to the System menu, a password can be configured for the control program. Password configuration can only be configured using nanoNavigator, the programming software. Refer to the “nanoNavigator User Manual” or Help system for additional information.

If a password is not configured, changes to the System menu are always possible when pressing the <Shift> and <OK> keys. From the System menu, the status of the password is displayed as “Not Set.”

```

rSelect      Status1
0 Monitor
1 Run/Stop - Running
Password - Not Set
Proj - Sprinkler Sy
4 Setup - PN 2701027
SF ▲ Exit

```

Figure 5-38 Password Not Set

If a password is configured, the System menus can be viewed by pressing the <Shift> and <OK> keys. However, parameters cannot be modified.

5.6.4 Project name

The System menu displays the project name as configured by the programmer in nanoNavigator. The project name can have up to 256 characters but only the first 12 characters are displayed on the Operator Panel.

```

rSelect      Status1
0 Monitor
1 Run/Stop - Running
Password - Not Set
Proj - Sprinkler Sy
4 Setup - PN 2701027
SF ▲ Exit

```

Figure 5-39 Project name

The Nanoline stores one project at a time. For information on downloading and uploading projects, refer to “Communication” on page 35.

5.6.5 Setup

The Setup screens provide information on operating parameters. The available parameters are dependent upon which modules are installed. For instance, the time and date are only available when the RTC option module is installed.

When a project is loaded, the System menu status field displays the part number of the base unit, i.e., PN 2701027. If no project is loaded, the status fields are blank.

From the System menu, press the <4> key to access setup parameters.

```

rSelect      Status1
0 Monitor
1 Run/Stop - Running
  Password - Not Set
  Proj - Spinkier Su
4 Setup - PN 2701027
SF ▲ Exit
    
```

Figure 5-40 Setup menu

```

rSelect
0 System Info
1 Set Date
2 Set Time
SF ▲ Back
    
```

Figure 5-41 Setup screen

5.6.5.1 System information

From the Setup screen, press the <0> key to access the system information for the Nanoline components installed.

```

Base Firmware V0100
Digital In 6 Out 4

I/O Expansion
#1 Dis In 6 Out 4

SF ▲ Back
    
```

Figure 5-42 System information screen

The first line lists the firmware installed in the base unit.



For information on updating the firmware, refer to the nanoNavigator User Manual.

The second and third lines list the type and quantity of digital channels on the base unit.

The fourth line is a header for I/O expansion modules installed.

Beginning on the fifth line are the type and quantity of digital channels on each I/O expansion module. A line only appears when a module is connected.

5.6.5.2 Set Date

From the Setup screen, press the <1> key to access the date screen. This screen is only applicable if the RTC option module is installed in Slot 2 of the base unit.



Figure 5-43 Set Date screen

To enter a date, use the keys on the Operator Panel to enter the current date. Press the <OK> button when finished. Press the ◀ or ▶ key to move to the next or previous fields. A battery is located in the RTC option module to allow retention of the date information.

5.6.5.3 Set Time

From the Setup screen, press the <2> key to access the time screen. This screen is only applicable if the RTC option module is installed in Slot 2 of the base unit.



Figure 5-44 Set Time screen

To enter a time, use the keys on the Operator Panel to enter the current time. Press the ◀ or ▶ key to move to the next or previous fields. Press the <OK> button when finished. The time information is stored in the base unit, even if power is removed from the unit. A battery is located in the RTC option module to allow retention of the time information.

5.6.6 Memory module

The MemMod screen provides access to the contents of the optional memory module installed in the base unit.

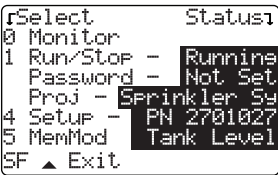

Figure 5-45 Memory module "Present"

When a project is loaded, the System menu indicates if a memory module is installed by displaying the project name on line 5. If not present, line 5 is not displayed. If a memory option module is present, from the System menu press the <5> key to access MemMod menu. The MemMod menu allows the user to:

- Upload the control project to the memory module
- Download the control project to the Nanoline
- Clear (delete) the program stored in the memory module

```
Memory Module
Proj - nanoLCTest
rSelect
0 Upload to Mem Mod
  nLC Running
2 Clear Mem Mod
SF ▲ Back
```

Figure 5-46 Memory Module menu with project running

From the Memory Module menu, press the corresponding key for the desired function.



The transfer or clearing of data to or from the module occurs very quickly. Although the transfer process is indicated by the LED on the module flashing, it rarely flashes more than once.

If the project is running, option 1 is not available until the project is stopped.

```
Memory Module
Proj - nanoLCTest
rSelect
0 Upload to Mem Mod
1 Download Mem Mod
2 Clear Mem Mod
SF ▲ Back
```

Figure 5-47 Memory Module menu with project stopped

For more information on how the optional memory module works, refer to “Memory Module” on page 37.

A Technical appendix

A 1 Modbus[®] holding registers



These registers are valid only for the Ethernet module, and may be different on other communication modules.

Holding register 0x0101: Base CPU commands (ModScan32 address: 40257)

15	14	13	12	11	10	9	8
Reserved	Reserved	Reserved	Reserved	Reserved	SR	BFU	UCS
0	0	0	0	0	0	0	0
7	6	5	4	3	2	1	0
Reserved	RFD	WAE	BOOTP	DHCP	PD	RRW	RO
0	0	0	0	1	0	0	0

where:

- RO: Read Only:
 - ON = Disable Write data (Read Only System)
 - OFF = System Reads and Writes to all data is allowed
- RRW: Restricted Read/Write
 - ON = Enable Restricted Read/Write
 - OFF = Disable Restricted Read/Write
- PD: Port Disable
 - ON = Turn off the port
 - OFF = Port on and accessible
- DHCP: DHCP
 - ON = DHCP Enable
 - OFF = DHCP Disable
- BOOTP: BOOTP
 - ON = BOOTP Enable
 - OFF = BOOTP Disable
- WAE: Web accesses enable
 - ON = Web access is enabled
 - OFF = Web access is disabled
- RFD: Reset to factory default
 - ON = Reset to factory default
 - OFF = Continue with current settings
- UCS: Update Configuration and Settings
 - ON = Update and apply the new configuration and settings from base module
 - OFF = Continue with the current settings

- BFU: Base Firmware Update
 ON = Base module wants to update firmware
 OFF = Normal operation.
- SR: Soft Reset
 ON = Reset the Ethernet Expansion Module (new application download)
 OFF = Normal Operation

DHCP	BOOTP	
1	X	IP Address settings by DHCP
0	1	IP Address settings by BOOTP
0	0	IP Address from nanoNavigator

Holding register 0x0102 for Ethernet module status (ModScan32 address: 40258)

15	14	13	12	11	10	9	8
Reserve d	Reserve d	Reserve d	Reserve d	Reserve d	Reserve d	Reserve d	Reserve d
7	6	5	4	3	2	1	0
Reserve d	Reserve d	IP- Conflict	BOOTP- Failed	DHCP- Failed	WDW	CC	MOK

where:

- MOK: "Module OK" (bit): Module is powered up, operational (no watchdog) and communicating with CPU.
 ON = OK
 OFF = Not present or not communicating
- CC: "Communications Connection" (bit): At least 1 active Modbus TCP connection exists.
 ON = 1 - 4 Connections (read or write) exist
 OFF = No communications connections exist
- WDW: "Write Data Watchdog" (bit): If the watchdog times out, the status bit turns on (transition of watchdog 0 > 1) When a connection is re-established (connection status transition 0 > 1), the bit is turned off.
 ON = Communications watchdog timed out (no write data)
 OFF = No Timeout
- DHCP-FAILED: "DHCP status bit" (valid only if DHCP bit in Base CPU Commands register is 1).
 ON = DHCP failed (unable to connect DHCP server)
 OFF = DHCP success
- BOOTP-FAILED: "BOOTP status bit" (valid only if BOOTP bit in Base CPU Commands register is 1).
 ON = BOOTP failed (unable to connect BOOTP server)
 OFF = BOOTP success
- IP-CONFLICT: This is valid only when default address is applied to the unit.
 ON = IP Address applied to the communication expansion module is duplicated on the network (expansion module will not work correctly)
 OFF = IP Address applied to the communication expansion module is unique in the network

Holding register 0x0103: IP Address 1 (ModScan32 address: 40259)

15	14	13	12	11	10	9	8
IP Address 1							
7	6	5	4	3	2	1	0
IP Address 2							

Holding register 0x0104: IP Address 2 (ModScan32 address: 40260)

15	14	13	12	11	10	9	8
IP Address 3							
7	6	5	4	3	2	1	0
IP Address 4							

Holding register 0x0105: Subnet mask 1 (ModScan32 address: 40261)

15	14	13	12	11	10	9	8
Subnet mask 1							
7	6	5	4	3	2	1	0
Subnet mask 2							

Holding register 0x0106: Subnet mask 2 (ModScan32 address: 40262)

15	14	13	12	11	10	9	8
Subnet mask 3							
7	6	5	4	3	2	1	0
Subnet mask 4							

Holding register 0x0107: Default gateway 1 (ModScan32 address: 40263)

15	14	13	12	11	10	9	8
Default Gateway 1							
7	6	5	4	3	2	1	0
Default Gateway 2							

Holding register 0x0108: Default gateway 2 (ModScan32 address: 40264)

15	14	13	12	11	10	9	8
Default Gateway 3							
7	6	5	4	3	2	1	0
Default Gateway 4							

Holding register 0x0109: Communications watchdog timer (ModScan32 address: 40265)

0 to 999.9 seconds in BDC format. For example, a register value of 0x0150 provides a watchdog time of 15.00 seconds

15	14	13	12	11	10	9	8

7	6	5	4	3	2	1	0

Holding register 0x010A: Response timeout count (ModScan32 address: 40266)

This register specifies the SPI Response Timeout in milliseconds

15	14	13	12	11	10	9	8

7	6	5	4	3	2	1	0

A 2 Modbus/Nanoline communication

Table A-1 Modbus function codes

Modbus reference type	Modbus commands allowed	Function code	Access
Coils	Read Coil Status	01	Bit
	Write Single Coil*	05	Bit
	Write Multiple Coils*	15	Bit
Discrete inputs	Read Discrete Inputs	02	Bit
Input registers	Read Input Register	04	Word
Holding registers	Read Holding Registers	03	Word
	Write Single Register*	06	Word
	Write Multiple Registers*	16	Word
	Read/Write Multiple Registers*	23	Word

* These commands will not function if the serial port configuration for Modbus RTU or the COM interface configuration for Modbus TCP are set to Read Only in nanoNavigator.

The ModScan32 request address range is shown in decimal only. The ModScan32 software does not start its addressing at 0 so all decimal ranges shown are offset by a factor of one, i.e. hexadecimal 0x1000 is the equivalent of decimal 4096, but because of ModScan32 addressing, the starting address is actually 4097. If using ModScan32 in the hexadecimal format, then hexadecimal 0x1000 actually equals 0x1001.

A 2.1 NLC-050... Modbus map

Table A-2 Coils 0-9999; Function codes 01, 05, 15

Nanoline variable type	Nanoline range	Modbus address range		ModScan32-only address range (decimal)
		Hexadecimal	Decimal	
Outputs	0-31	0x0000-0x001F	0000-0031	0001-0032
Flags	0-63	0x1000-0x103F	4096-4159	4097-4160
System Status Flags	64-71	0x1040-0x1047	4160-4167	4161-4168
Ethernet Command/Status Flags	72-103	0x1048-0x1067	4168-4199	4169-4200

Table A-3 Discrete inputs 10000-19999; Function code 02

Nanoline variable type	Nanoline range	Modbus address range		ModScan32-only address range (decimal)
		Hexadecimal	Decimal	
Inputs	0-31	0x0000-0x001F	0000-0031	0001-0032

Table A-4 Input register 30000-39999; Function code 04

Nanoline variable type	Nanoline range	Modbus address range		ModScan32-only address range (decimal)
		Hexadecimal	Decimal	
Analog Inputs	0-7	0x0000-0x0007	0000-0007	0001-0008

Table A-5 Holding registers 40000-49999; Function codes 03, 06, 16, 23

Nanoline variable type [*]	Nanoline range	Modbus address range		ModScan32-only address range (decimal)
		Hexadecimal	Decimal	
Register [†]	0-31	0x0000-0x003F	0000-0063	0001-0064
Timer/Counter Preset [†]	0-31	0x2000-0x203F	8192-8255	8193-8256
Output Time Preset [†]	0-31	0x3000-0x303F	12288-12351	12289-12352
Timer/Counter Accum [†]	0-31	0x5000-0x503F	20480-20543	20481-20544
Output Time Accum	0-31	0x6000-0x603F	24576-24639	24577-24640

* These variable types are 32-bit values in the Nanoline and, therefore, occupy two Modbus register addresses. The byte order is Little-endian, first byte contains LSB (i.e., the low-order 16-bits of Nanoline Timer/Counter Preset 0 would occupy Modbus Request Address 0x2000 and the high-order 16-bits of Nanoline Timer/Counter Preset 0 would occupy Modbus Request Address 0x2001. Nanoline Timer/Counter Preset 1 would occupy Modbus Request Addresses 0x2002 and 0x2003)

† Multiple Modbus commands may be required to view the entire Modbus range.

A 2.2 NLC-055... Modbus map

Table A-6 Coils 0-9999; Function codes 01, 05, 15 (NLC-055... units)

Nanoline variable type	Nanoline range	Modbus address range		ModScan32-only address range (decimal)
		Hexadecimal	Decimal	
Outputs	0-63	0x0000-0x003F	0000-0063	0001-0064
Flags	0-127	0x1000-0x107F	4096-4159	4097-4224
System Status Flags	128-135	0x1081-0x1087	4225-4231	4226-4232
Ethernet Command/Status Flags	136-167	0x1089-0x10A7	4233-4263	4234-4264

Table A-7 Discrete inputs 10000-19999; Function code 02 (NLC-055... units)

Nanoline variable type	Nanoline range	Modbus address range		ModScan32-only address range (decimal)
		Hexadecimal	Decimal	
Inputs	0-63	0x0000-0x003F	00000-0063	0001-0064

Table A-8 Input register 30000-39999; Function code 04 (NLC-055... units)

Nanoline variable type	Nanoline range	Modbus address range		ModScan32-only address range (decimal)
		Hexadecimal	Decimal	
Analog Inputs	0-7	0x0000-0x0007	0000-0007	0001-0008

Table A-9 Holding registers 40000-49999; Function codes 03, 06, 16, 23 (NLC-055... units)

Nanoline variable type*	Nanoline range	Modbus address range		ModScan32-only address range (decimal)
		Hexadecimal	Decimal	
Register†	0-127	0x0000-0x00FF	0000-0255	0001-0256
Analog Output	0-7	0x1000-0x1007	4096-4103	4097-4104
Timer/Counter Preset†	0-31	0x2000-0x203F	8192-8255	8193-8256
Output Time Preset	0-63	0x3000-0x307F	12288-12415	12289-12416
High Speed Preset	0-1	0x4000-0x4003	16384-16387	16385-16388
Timer/Counter Accum†	0-31	0x5000-0x503F	20480-20543	20481-20544
Output Time Accum	0-63	0x6000-0x607F	24576-24703	24577-24704
High Speed Accum	0-1	0x7000-0x7003	28672-28675	28673-28676

* These variable types are 32-bit values in the Nanoline and, therefore, occupy two Modbus register addresses. The byte order is Little-endian, first byte contains LSB (i.e., the low-order 16-bits of Nanoline Timer/Counter Preset 0 would occupy Modbus Request Address 0x2000 and the high-order 16-bits of Nanoline Timer/Counter Preset 0 would occupy Modbus Request Address 0x2001. Nanoline Timer/Counter Preset 1 would occupy Modbus Request Addresses 0x2002 and 0x2003)

† Multiple Modbus commands may be required to view the entire Modbus range.

A 3 Special formats

There are a few data item types that require special handling when using Modbus commands. These involve special formatting in either an HH:MM:SS (Time) or MM:DD:YY (Date).

Within the nanoLC controller, the formatting for these data item types is stored in a 32-bit format that is divided into four bytes using a binary number system. Each field corresponds to a byte.

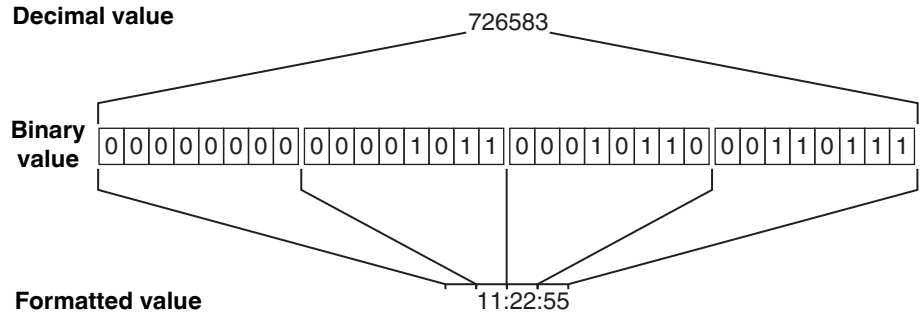

Figure A-1 Time-formatted data item type using binary format

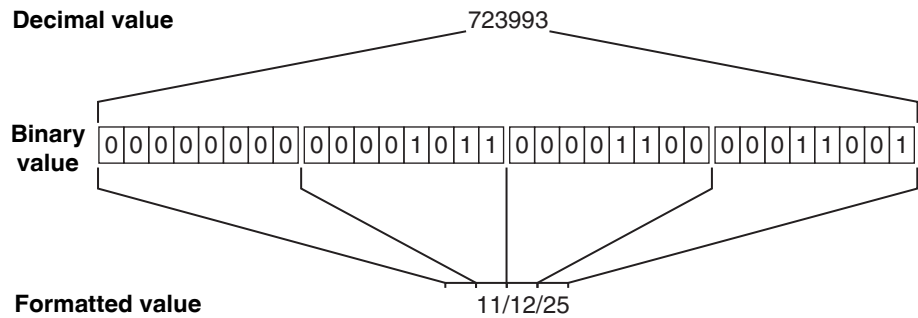

Figure A-2 Date-formatted data item type using binary format

Convert the decimal value to a hex format using Microsoft® Calculator or equivalent. Each pair of hex digits are individually converted to decimal format.

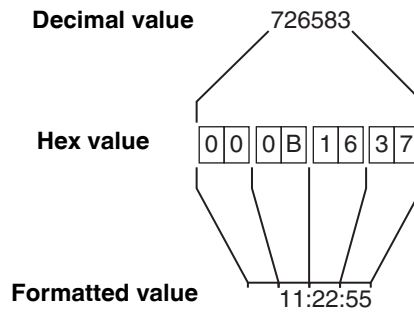

Figure A-3 Time-formatted data item type conversion using hex format

B Technical appendix – Status/command flags

nanoLC has predefined system flags that provide status information during project execution. These flags are available through nanoNavigator.

Flags that appear in the Data Item Editor depend on the product and configuration options specified. For instance, the NLC-050... does not have math capability and the NLC-055... does. Therefore, flags associated with math functions are not valid for NLC-050... systems.



Not all flags are present with all configurations. Only flags that applicable for the hardware installed appear.



Refer to the GSM manual for flags related to the GSM module.

B 1 NLC-050... flags

These flags only apply to systems that use NLC-050... base units.

The base unit status flags are read-only.

Table B-1 Base unit status flags

Flag	Name	Description
F-64	No Real-Time Clock	On if RTC is missing at startup, or missing at one hour check
F-65	Real-Time Clock Battery Low	On if RTC is present and battery is low
F-66	No Operator Panel	On if an Operator Panel is configured in nanoNavigator but it is not connected or functioning
F-67	No Communications Module	On if a Communications module is configured in nanoNavigator but it is not connected or running
F-68	Serial Modbus RTU Timeout	On if Modbus RTU Timeout Value != 0; and A Modbus RTU Command has been received since startup; and The timeout value was exceeded between Modbus commands
F-69	Reserved 1	Reserved for future use
F-70	Reserved 2	Reserved for future use
F-71	nanoLC Stopped	On if the project has stopped running

Ethernet command flags provide a way to configure the Ethernet module, when installed. Some commands are specific to the Nanoline and others allow control from a remote device via the Ethernet connection.

- Ethernet flags represent the bits of Modbus Holding Registers 0x0101 (Command register) and 0x0102 (Status register).
- Flags 72-87 are commands (see Table B-2) and may be turned on or off.

- Flags 88-103 are status flags (see Table B-3) and are read only.



If the NLC-COM-GSM module is installed, some flags may be used for other purposes. Refer to the NLC-COM-GSM user manual for GSM flags.

Table B-2 Ethernet command flags

Flag	Name	Description
F-72	ETH Set Read-Only Mode	On sets all data items to be read-only when accessed through the Ethernet port
F-73	ETH Command 01 (Reserved)	Reserved for future use
F-74	ETH Disable Port	On disables the Ethernet port from remote access from outside network sources
F-75	ETH Request DHCP	On requests the Ethernet module to enter a mode asking for an IP Address from a DHCP server
F-76	ETH Request BOOTP	On requests the Ethernet module to enter a mode asking for an IP Address from a BOOTP server
F-77	ETH Enable Web Access	On allows the Ethernet module's web server to be accessed from a network connection
F-78	ETH Reset to Factory Default	On resets the Ethernet module's configuration data to the factory default settings; the IP Address is also reset to 0.0.0.0
F-79	ETH Command 07 (Reserved)	Reserved for future use
F-80	ETH Command 08 (Reserved)	Reserved for future use
F-81	ETH Request Boot	On requests the Ethernet module to stop communicating to the base to allow the base module to enter bootloader mode.
F-82	ETH Request Reset	On requests the Ethernet module reset itself to the stored settings
F-83	ETH Command 11 (Reserved)	Reserved for future use
F-84	ETH Command 12 (Reserved)	Reserved for future use
F-85	ETH Command 13 (Reserved)	Reserved for future use
F-86	ETH Command 14 (Reserved)	Reserved for future use
F-87	ETH Command 15 (Reserved)	Reserved for future use

Ethernet status flags provide the current status of the Ethernet module and connection. They are read-only.

Table B-3 Ethernet status flags

Flag	Name	Description
F-88	ETH Module OK	On if the Ethernet module is operating properly
F-89	ETH Connection Established	On if the Modbus/TCP Ethernet connection has been established from a host computer
F-90	ETH Write Data Watchdog	On if the Watchdog timer has expired without receiving a Write command from any connected Modbus/TCP host computer
F-91	ETH DHCP Failed	On if the Ethernet module is configured to obtain its address from a DHCP server, but either the assignment failed or a DHCP server is not present on the network
F-92	ETH BOOTP Failed	On if the Ethernet module is configured to obtain its address from a BOOTP server, but either the assignment failed or a BOOTP server is not present on the network
F-93	ETH IP Conflict	On if another device on the network has the same IP address as this Ethernet module
F-94	ETH Status 06 (Reserved)	Reserved for future use
F-95	ETH Status 07 (Reserved)	Reserved for future use
F-96	ETH Status 08 (Reserved)	Reserved for future use
F-97	ETH Status 09 (Reserved)	Reserved for future use
F-98	ETH Status 10 (Reserved)	Reserved for future use
F-99	ETH Status 11 (Reserved)	Reserved for future use
F-100	ETH Status 12 (Reserved)	Reserved for future use
F-101	ETH Status 13 (Reserved)	Reserved for future use
F-102	ETH Status 14 (Reserved)	Reserved for future use
F-103	ETH Status 15 (Reserved)	Reserved for future use

B 2 NLC-055... flags

These flags only apply to systems that use NLC-055... base units.

The base unit status flags are read-only.

Table B-4 Base unit status flags

Flag	Name	Description
F-128	Invalid RTC Date/Time	On if the internal clock is not set
F-129	Reserved 1	Reserved for future use
F-130	No Operator Panel	On if an Operator Panel is configured in nanoNavigator but it is not connected or functioning
F-131	No Communication Module	On if a Communications module is configured in nanoNavigator but it is not connected or running
F-132	Serial Modbus RTU Timeout	On if Modbus RTU communications has timed out
F-133	Overflow	On if the result of a math operation exceeds the minimum or maximum allowable values
F-134	Divide By Zero	On if an illegal math operation is entered, such as dividing by 0. This flag is reset to off for the next math block.
F-135	nanoLC Stopped	On if the project has stopped running

Ethernet command flags provide a way to configure the Ethernet module, when installed. Some commands are specific to the Nanoline and others allow control from a remote device via the Ethernet connection.

- Ethernet flags represent the bits of Modbus holding registers 0x0101 (Command register) and 0x0102 (Status register).
- Flags 136-151 are commands (see Table B-5) and may be turned on or off.
- Flags 152-167 are status flags (see Table B-6) and are read only.



If the NLC-COM-GSM or NLC-COM-CELLULAR-CDMA module is installed, some flags may be used for other purposes. Refer to the NLC-COM-GSM user manual for GSM flags.

Table B-5 Ethernet command Flags

Flag	Name	Description
F-136	ETH Set Read Only Mode	On sets all data items to be read-only when accessed through the Ethernet port
F-137	ETH Command 01	Reserved for future use
F-138	ETH Disable Port	On disables the Ethernet port from remote access from outside network sources
F-139	ETH Request DHCP	On requests the Ethernet module to enter a mode asking for IP Address from DHCP server
F-140	ETH Request BOOTP	On requests the Ethernet module to enter a mode asking for an IP Address from a BOOTP server
F-141	ETH Enable Web Access	On allows the Ethernet module's web server to be accessed from a network connection
F-142	ETH Reset to Factory Default	On resets the Ethernet modules configuration data to the factory default settings. The IP Address is also reset to 0.0.0.0
F-143	ETH Command 07	Reserved for future use
F-144	ETH Command 08	Reserved for future use
F-145	ETH Request Boot	On requests the Ethernet module to stop communicating to the base to allow the base module to enter boot loader mode.
F-146	ETH Request Reset	On requests the Ethernet module to reset itself to the stored settings
F-147	ETH Command 11	Reserved for future use
F-148	ETH Command 12	Reserved for future use
F-149	ETH Command 13	Reserved for future use
F-150	ETH Command 14	Reserved for future use
F-151	ETH Command 15	Reserved for future use

Table B-6 Ethernet status flags

Flag	Name	Description
F-152	ETH Module OK	On if the Ethernet module is operating properly
F-153	ETH Communications Connection Established	On if a Modbus/TCP Ethernet connection has been established from a host computer
F-154	ETH Write Data Watchdog Status	On if the Watchdog timer has expired without receiving a Write command from any connected Modbus/TCP host computer.
F-155	ETH DHCP Failed	On if the Ethernet module is configured to obtain its address from a DHCP server, but either the assignment failed or a DHCP server is not present on the network
F-156	ETH BOOTP Failed	On if the Ethernet module is configured to obtain its address from a BOOTP server, but either the assignment failed or a BOOTP server is not present on the network
F-157	ETH IP Conflict	On if another device on the network has the same IP address as this Ethernet module
F-158	ETH Status 06	Reserved for future use
F-159	ETH Status 07	Reserved for future use
F-160	ETH Status 08	Reserved for future use
F-161	ETH Status 09	Reserved for future use
F-162	ETH Status 10	Reserved for future use
F-163	ETH Status 11	Reserved for future use
F-164	ETH Status 12	Reserved for future use
F-165	ETH Status 13	Reserved for future use
F-166	ETH Status 14	Reserved for future use
F-167	ETH Status 15	Reserved for future use

C Technical appendix – Commissioning

Commissioning is the process of installing and verifying operation of a device. This appendix provides information to aid in installation and troubleshooting of the Nanoline product family.

C 1 Hot-swappable modules

Some Nanoline modules allow plugging and unplugging without removing power (hot-swappable).

They are:

Table C-1 Hot-swappable components

Component	Name	Hot-swappable
RS-232 option module	NLC-MOD-RS232	No
RS-485 option module	NLC-MOD-RS485	No
USB option module	NLC-MOD-USB	No
Memory module	NLC-MOD-MEM 032K	No
Real-time clock	NLC-MOD-RTC	No
Operator Panel	NLC-OP1-LCD-032-4X20	Yes
Ethernet module	NLC-COM-ENET-MB1	No
GSM module	NLC-COM-GSM	No
CDMA module	NLC-COM-CELLULAR-CDMA	No
I/O expansion modules		No

C 2 Commissioning checklist

As an aid to commissioning a Nanoline, the following tables are provided. These should be used as a guide to follow during the commissioning process, and to record various setup and connection data. When completed, the checklists can be kept in the job file. The checklist will be valuable if changes are required to the system, or for troubleshooting.

For each item, place an X in the Status column, along with your initials and the date completed. If further work is required, enter that information in the Action column. If desired, comments can be added for further clarity, such as issues that were fixed or work-arounds.

Table C-2 Suggested pre-commissioning checklist

Checklist Item	Status*	Action	Initials	Completion Date	Comments
Controller mounting (According to this document Chapter 2)					
Installation of field equipment According to manufacturer's specification					
Labeling All wires labeled as listed in documentation					
Power wiring Follow local, state and country regulations					
End-to-end checks Voltages, continuity, polarity & destination					
Field wiring All devices checked, all devices switched off					
Power availability Ensure proper line voltage					
Visual inspection of controller wiring					
Check for AC voltages Use meter					
Check for DC voltages Use meter					
Check for short circuits to earth ground Use meter					
Check for short circuits between terminals Use meter					

* Suggested status codes; X - Completed; NA - Not applicable

Table C-3 Power up and functionality checklist

Checklist item	Status*	Action	Initials	Completion date	Comments
Turn power ON Apply power to the nanoLC					
Operator Panel Illuminates with information on screen					
Connecting to a PC Use RS-232, RS-485 or USB cable					
Starting the nanoLC controller Opens to project created screen or Select Menu					
Loading the program into the nanoLC Download using nanoNavigator					
Addressing the inputs Check physical inputs to programmed inputs					
Addressing the outputs Check physical outputs to programmed outputs					
Memory addresses Check registers and flags					
Checking the analog field points Check any analog inputs					
Control strategy Check programmed control logic manually					
Ethernet installation checks Check Ethernet operations					
Ethernet wiring and hardware checks Check Ethernet wiring					
Ethernet data transmission Check communications using Modscan32 software					

* Suggested status codes; X - Completed; NA - Not applicable

C 3 Points chart

The points chart records each configured input and output point. This can be provided to the installer for connection information and stored in the job folder for use in maintenance and troubleshooting. Note that the Label can be edited in nanoNavigator but is not visible when using the Operator Panel.

The type of input or output is dependent on the base unit or expansion module installed. In addition, different base units and expansion modules have different amounts of inputs and outputs, so it is recommended to list which module has the physical connection.

Table C-4 Output points list

Module	Hardware ID	Software ID	Type	Label	Comments
Base	Q0	Q-00			
Base	Q1	Q-01			
Base	Q2	Q-02			
Base	Q3	Q-03			
		Q-04			
		Q-05			
		Q-06			
		Q-07			
		Q-08			
		Q-09			
		Q-10			
		Q-11			
		Q-12			
		Q-13			
		Q-14			
		Q-15			

Table C-5 Input points list

Module	Hardware ID	Software ID	Type	Label	Comments
Base	I0	I-00			
Base	I1	I-01			
Base	I2	I-02			
Base	I3	I-03			
Base	I4	I-04			
Base	I5	I-05			
		I-06			
		I-07			
		I-08			
		I-09			
		I-10			
		I-11			
		I-12			
		I-13			
		I-14			
		I-15			
		I-16			
		I-17			
		I-18			
		I-19			
		I-20			
		I-21			
		I-22			
		I-23			

Table C-6 Analog points list

Module	Hardware ID	Software ID	Type	Label	Comments
		AQ-00			
		AQ-01			
		AQ-02			
		AQ-03			
		AQ-04			
		AQ-05			
		AQ-06			
		AQ-07			
		AQ-08			
		AI-01			
		AI-02			
		AI-03			
		AI-04			
		AI-05			
		AI-06			
		AI-07			
		AI-08			

D Technical Appendix – Technical data

D 1 Ordering data

Products

Description	Type	Order No.	Pcs./Pkt.
Nanoline base unit controller , 24 V DC input power, 6 digital inputs, 4 PNP transistor outputs	NLC-050-024D-06I-04QTP-00A	2701027	1
Nanoline base unit controller , 24 V DC input power, 6 digital inputs, 4 NPN transistor outputs	NLC-050-024D-06I-04QTN-00A	2701030	1
Nanoline base unit controller , 24 V DC input power, 6 digital inputs, 4 relay outputs	NLC-050-024D-06I-04QRD-05A	2701043	1
Nanoline base unit controller , 24 V AC/DC input power, 8 digital inputs, 4 relay outputs	NLC-050-024X-08I-04QRX-05A	2701056	1
Nanoline base unit controller , 100 to 240 V AC input power, 8 digital inputs, 4 relay outputs	NLC-050-100A-08I-04QRA-05A	2701069	1
Nanoline base unit controller , 24 V DC input power, 2 analog inputs, 8 digital inputs, 4 PNP transistor outputs, 2 high-speed counters, RTC	NLC-055-024D-08I-04QTP-00A	2700453	1
Nanoline base unit controller , 24 V DC input power, 2 analog inputs, 8 digital inputs, 4 relay outputs, 2 high-speed counters, RTC	NLC-055-024D-08I-04QRD-05A	2700464	1
Nanoline base unit controller , 12 V DC input power, 2 analog inputs, 8 digital inputs, 4 NPN transistor outputs, 2 high-speed counters, RTC	NLC-055-012D-08I-04QRD-05A	2700486	1
Nanoline base unit controller , 100 to 240 V AC input power, 8 digital inputs, 4 relay outputs, RTC	NLC-055-100A-08I-04QRA-05A	2700487	1
Nanoline base unit controller , 24 V DC input power, 4 digital inputs, 2 relay outputs, RTC	NLC-035-024D-04I-02QRD-05A	2702031	1
Nanoline base unit controller , 24 V DC input power, 4 digital inputs, 2 relay outputs, RTC	NLC-040-024D-04I-02QRD-05A	2400079	1
Nanoline I/O expansion module , 24 V DC, 6 digital inputs, 4 PNP transistor outputs	NLC-IO-06I-04QTP-01A	2701072	1
Nanoline I/O expansion module , 24 V DC, 6 digital inputs, 4 NPN transistor outputs	NLC-IO-06I-04QTN-01A	2701085	1
Nanoline I/O expansion module , 24 V DC, 3 digital inputs, 4 DC relay outputs	NLC-IO-03I-04QRD-01A	2701328	1
Nanoline I/O expansion module , 24 V DC, 3 digital inputs, 4 DC relay outputs	NLC-IO-03I-04QRA-05A	2701960	1
Nanoline I/O expansion module , 4 analog inputs	NLC-IO-4AI	2701098	1
Nanoline I/O expansion module , 2 analog inputs, 2 analog outputs	NLC-IO-2AI2AO	2701040	1
Nanoline I/O expansion module , 2 temperature inputs, 4 PNP transistor outputs	NLC-IO-2RTD/UTH-4QTP-01A	2701671	1
Nanoline I/O expansion module , 4 PNP inputs, 2 relay outputs, for use with NLC-035... and NLC-040...	NLC-IOX-04I-02QRD-05A	2702032	1
Nanoline Ethernet communications module , 10/100 kbaud, Modbus TCP server	NLC-COM-ENET-MB1	2701124	1
Nanoline GSM communications module , 12 to 24 V DC input power, modem	NLC-COM-GSM	2701344	1
Nanoline CDMA communications module , 12 to 24 V DC input power, modem, operates on a Verizon CDMA network	NLC-COM-CELLULAR-CDMA	2400428	1
Nanoline Operator Panel , LCD display, 15 programmable buttons	NLC-OP1-LCD-032-4X20	2701137	1
Nanoline Operator Panel , LCD display, 15 programmable buttons	NLC-OP2-LCD-076-4X20	2701945	1
Remote mounting kit , to mount Operator Panel in an enclosure, includes 60 cm cable	NLC-OP1-MKT	2701140	1
Operator Panel cable , RJ45 to RJ45, 60 cm, for remote display	NLC-OP1-MKT-CBL	2701438	1
Operator Panel cable , RJ45 to DSUB 9, 290 cm, for NLC-OP2-LCD-076-4X20 and NLC-OP1-MKT	NLC-OP2-RJ45-CBL	2400195	1
Operator Panel cable , RJ12 to DSUB 9, 290 cm, for NLC-OP2-LCD-076-4X20 and NLC-035-024D-04I-02QRD-05A	NLC-OP2-RJ11-CBL	2400196	1

Nanoline

Products

Description	Type	Order No.	Pcs./Pkt.
USB communication module , connects to PC using USB port	NLC-MOD-USB	2701195	1
RS-232 communication module , connects to PC using RS-232 port	NLC-MOD-RS232	2701179	1
RS-485 communication module , connects to PC using RS-485 port	NLC-MOD-RS485	2701182	1
Serial cable , D-SUB 9 to RJ11/12	NLC-PC/SERIAL-CBL 1M	2701234	1
Serial cable , USB Type A to Type B	NLC-PC/USB-CBL 2M	2701247	1
Serial cable , RJ11 to open, 5 m	NLC-RS485-CBL 5M	2701073	1
Serial cable , USB to RJ11, 2 m	NLC-USB to SERIAL-CBL 2M	2400111	1
Real-time clock module , provides time storage in off-power situations	NLC-MOD-RTC	2701153	1
nanoNavigator configuration software	NLC-NAV-01	2701221	1

D 2 Technical specifications

D 2.1 NLC-050... base unit

General					
	2701027	2701030	2701043	2701056	2701069
Dimensions (H x W x D)	103 x 80 x 60 mm				
Weight	240 g		260 g	248 g	268 g
Degree of protection	IP20				
Class of protection	Class III, EN 61131-2, IEC 61131-2				
Connection method	Screw terminal, 0.2 - 2.5 mm ² , 12-24 AWG, 0.5-0.6 Nm				
Operating temperature range *	-25...60°C			-25...55°C	
Storage temperature range	-25...85°C				
Humidity (maximum) @ 25°C	90%				

* Temperature range of 0... 50°C with Operator Panel installed

System data					
	2701027	2701030	2701043	2701056	2701069
Number of expansion modules	3				
Number of communication expansion modules	1				
Number of base unit option modules	2				

Supply voltages					
	2701027	2701030	2701043	2701056	2701069
Base power (nominal)	24 V DC			24 V AC/DC	100... 240 V AC
Base power permissible range (ripple included)	19.2...30 V DC			19...30 V DC 19...26 V AC	100... 240 V AC
Typical current consumption	92 mA		150 mA	150 mA @ 24 DC	70 mA @ 230 V AC
Maximum current consumption	250 mA				-
Protection	Reverse polarity				

Digital inputs					
	2701027	2701030	2701043	2701056	2701069
Number	6		8		
Connection method	Screw terminal, 0.2 - 2.5 mm ² , 12-24 AWG, 0.5-0.6 Nm				
Input design	EN 61131-2 Type 1 (NPN or PNP)				
Nominal input voltage	24 V DC		24 V AC/DC		115/230 V AC
Input voltage range "0" signal	0...5 V			0...25 V	
Input voltage range "1" signal	15...30 V			80...250 V	
Nominal input current ON	5 mA DC			0.17 mA AC	
Nominal input current OFF	1 mA		-		
Response time ON	60 μs		20 ms		
Response time OFF	70 μs		-		
Protection	Polarity reversal				
Permissible cable length to sensor	100 m				
High speed counter, square wave (minimum pulse width of 60 μs)	-				

Digital outputs					
	2701027	2701030	2701043	2701056	2701069
Output type	PNP transistor	NPN transistor	AC/DC relay		
Number			4		
Nominal power supply V _N	24 V DC		-		
Connection method	Screw terminal, 0.2 - 2.5 mm ² , 12-24 AWG, 0.5-0.6 Nm				
Maximum switching voltage @ V _N	23 V DC	23 V DC	-		
Minimum switching voltage @ V _N	0.8 V DC	1 V DC	-		
Maximum switching voltage	-		30 V DC/250 V AC		
Maximum switching current	-		5 A @ 30 V DC/5 A @ 120...250 V AC		
Maximum current per channel	0.5 A		5 A		
Maximum current per module	2.0 A		20 A		
Differential voltage	1 V DC	1 V DC	-		
Nominal load					
Ohmic	12 W		600 W @ 24 Ω		
Lamp	12 W		-		
Inductive	12 VA (1.2 H)		-		
Motor inrush current	-		5 A @ 120 V AC / 5 A @ 240 V AC		
Motor full load current	-		1.5 @ 120 V AC / 0.9 @ 240 V AC		
Signal delay @ 20°C (excluding bounce)	-		10 ms		
Release time @ 20°C (excluding bounce)	-		4 ms		
Mechanical service life	-		10 x 10 ⁶ cycles		
Electrical service life (see Figure D-1)	-		100,000 cycles		
Operating frequency					
No load	100 Hz		300 operations per minute		
Rated load	100 Hz		30 operations per minute		
Overload response	Restart after removal of overload		External protection required.		
Protection	Thermal fuse		External protection required.		

D 2.2 NLC-055... base unit

General				
	2700453	2700464	2700486	2700487
Dimensions (H x W x D)	103 x 80 x 60 mm			
Weight	178 g	262 g	248 g	150 g
Degree of protection	IP20			
Class of protection	Class III, EN 61131-2, IEC 61131-2			
Connection method	Screw terminal, 0.2 - 2.5 mm ² , 12-24 AWG, 0.5-0.6 Nm			
Operating temperature range *	-25...60°C		-25...60°C	
Storage temperature range	-25...85°C			
Humidity (maximum) @ 25°C	90%			

* Temperature range of 0... 50°C with Operator Panel installed

System data				
	2700453	2700464	2700486	2700487
Number of expansion modules				3
Number of communication expansion modules				1
Number of base unit option modules				2

Supply voltages				
	2700453	2700464	2700486	2700487
Base power (nominal)	24 V DC		12 V DC	100... 240 V AC
Base power permissible range (ripple included)	19.2...30 V DC		9...15 V DC	100... 240 V AC
Typical current consumption	100 mA	150 mA	250 mA	50 mA @ 230 V AC
Maximum current consumption	250 mA	250 mA	400 mA	70 mA @ 110 V AC
Protection	Reverse polarity			

Digital inputs				
	2700453	2700464	2700486	2700487
Number	8			
Connection method	Screw terminal, 0.2 - 2.5 mm ² , 12-24 AWG, 0.5-0.6 Nm			
Input design	EN 61131-2 Type 1 (NPN or PNP)			
Nominal input voltage	24 V DC		12 V DC	115/230 V AC
Input voltage range "0" signal	0...5 V		0...5 V	0...25 V
Input voltage range "1" signal	15...30 V		10.2...14.4 V	80...250 V
Nominal input current ON	5 mA DC		3 mA @ 12 V DC	0.4 mA @ 120 V AC 0.80 mA @ 240 V AC
Nominal input current OFF	1 mA		1 mA	-
Response time ON	60 μs		60 μs	20 ms
Response time OFF	70 μs		40 μs	-
Protection	Polarity reversal			
Permissible cable length to sensor	100 m			
High speed counter, square wave (minimum pulse width of 60 μs)	6 kHz		-	

* Input current draw does not meet IEC 61131-2 requirements

Digital outputs				
	2700453	2700464	2700486	2700487
Output type	PNP transistor	AC/DC relay		
Number	4			
Nominal power supply V _N	24 V DC		12 V DC	100-240 V AC
Connection method	Screw terminal, 0.2 - 2.5 mm ² , 12-24 AWG, 0.5-0.6 Nm			
Maximum switching voltage @ V _N	23 V DC		-	
Minimum switching voltage @ V _N	0.8 V DC		-	
Maximum switching voltage	-	30 V DC/250 V AC		
Maximum switching current	-	5 A @ 30 V DC/5 A @ 120...250 V AC		
Maximum current per channel	0.5 A	5 A		
Maximum current per module	2.0 A	20 A		
Differential voltage	1 V DC	-		
Nominal load				
Ohmic	12 W		600 W @ 24 Ω	
Lamp	12 W		-	
Inductive	12 VA (1.2 H)		-	
Motor inrush current	-		5 A @ 120 V AC / 5 A @ 240 V AC	
Motor full load current	-		1.5 @ 120 V AC / 0.9 @ 240 V AC	
Signal delay @ 20°C (excluding bounce)	-	10 ms		
Release time @ 20°C (excluding bounce)	-	4 ms		
Mechanical service life	-	10 x 10 ⁶ cycles		
Electrical service life (see Figure D-1)	-	100,000 cycles		

Digital outputs (continued)		
Operating frequency		
No load	100 Hz	300 operations per minute
Rated load	100 Hz	30 operations per minute
Overload response	Restart after removal of overload	External protection required.
Protection	Thermal fuse	External protection required.

Analog inputs				
	2700453	2700464	2700486	2700487
Number		2		0
Connection method	Screw terminal, 0.2 - 2.5 mm ² , 12-24 AWG, 0.5-0.6 Nm			-
Nominal input consumption		500 µA		-
Maximum input consumption		900 µA		-
Signal input voltage		0...10 V DC		-
Input type	Single ended, common ground			-
Maximum permanent overload		10 V DC		-
Input resistance of voltage input		20 kΩ		-
Least significant bit		2.44 mV		-
Resolution		12 bit monotonic		-
Cut-off frequency (3 dB)		1 Hz		-
Basic error limit, full scale		2.00 %		-
Input filter		Digital		-
Conversion method	Successive approximation			-
Protection	Transient voltage suppression			-

D 2.3 NLC-035... and NLC-040 base units

General		
	2702031	2400079
Dimensions (H x W x D)	103 x 40 x 43 mm	
Weight	106 g	
Degree of protection	IP20	
Class of protection	Class III, EN 61131-2, IEC 61131-2	
Connection method	Screw terminal, 0.2 - 2.5 mm ² , 12-24 AWG, 0.5-0.6 Nm	
Operating temperature range	-25...70°C	
Storage temperature range	-25...85°C	
Humidity (maximum) @ 25°C	90%	
System data		
	2702031	2400079
Number of expansion modules	1	
Number of communication expansion modules	1	
Number of base unit option modules	0	

Supply voltages		
	2702031	2400079
Base power (nominal)	24 V DC	
Base power permissible range (ripple included)	19.2...30 V DC	
Typical current consumption	74 mA	
Maximum current consumption	81 mA	
Protection	Reverse polarity	

Digital inputs		
	2702031	2400079
Number	4	
Connection method	Screw terminal, 0.2 - 2.5 mm ² , 12-24 AWG, 0.5-0.6 Nm	
Input design	EN 61131-2 Type 1 (PNP)	
Nominal input voltage	24 V DC	
Input voltage range "0" signal	0...5 V	
Input voltage range "1" signal	11...30 V	
Nominal input current ON	1.2 mA DC (channel 1 and 2) 0.13 mA (channel 3 and 4)	
Nominal input current OFF	1 mA	
Response time	10 μs (channel 1 and 2) 2 ms (channel 3 and 4)	
Protection	Polarity reversal	
Permissible cable length to sensor	100 m	
Number of high-speed counters	2 (channel I0 and I1)	
High-speed counter, square wave (minimum pulse width of 60 μs)	10 kHz	

Relay outputs	
	Relay
Output type	Relay
Number	2
Nominal power supply V_N	24 V DC
Connection method	Screw terminal, 0.2 - 2.5 mm ² , 12-24 AWG, 0.5-0.6 Nm
Maximum switching voltage	30 V DC/250 V AC
Maximum switching current	5 A @ 30 V DC/5 A @ 120...250 V AC
Maximum current per channel	5 A
Maximum current per module	10 A
Differential voltage	1 V
Nominal load	
Ohmic	7.2 W (80 Ω)
Lamp	7.2 W
Inductive	7.2 VA (1.2 H, 80 Ω)
Operating frequency	
No load	100 Hz
Rated load	100 Hz
Overload response	Restart after removal of overload
Protection	External protection required

D 2.4 Digital I/O expansion module

General				
	2701072	2701085	2701328	2701960
Dimensions (H x W x D)	103 x 40 x 43 mm			
Weight	88 g	92 g	136 g	140 g
Degree of protection	IP20			
Connection method	D-SUB 9			
Operating temperature range	-25...60°C		-25...55°C	
Storage temperature range	-25...85°C			
Humidity (maximum) @25°C	90%			

Digital inputs				
	2701072	2701085	2701328	2701960
Number	6	6	3	3
Connection method	Screw terminal, 0.2 - 2.5 mm ² , 12-24 AWG, 0.5-0.6 Nm			
Input design	EN 61131-2 Type 1			
Nominal input voltage	24 V DC		24 V AC/DC	240 V AC
Input voltage range "0" signal	0...5 V DC		0...5 V AC/DC	0...80 V AC
Input voltage range "1" signal	15...30 V DC		10.2...30 V AC/DC	100...240 V AC
Nominal input current ON		5 mA		1.38 mA
Nominal input current OFF		1 mA		0.2 mA
Response time ON	60 μs		600 μs	850 μs
Response time OFF	70 μs		700 μs	960 μs
Protection	Polarity reversal		-	
Permissible cable length to sensor			100 m	

Outputs				
	2701072	2701085	2701328	2701960
Output type	PNP	NPN	AC/DC Relay	AC/DC Relay
Number	4			
Nominal power supply V_N	24 V DC		12 V DC 24 V AC/DC	120 V AC 240 V AC
Connection method	Screw terminal, 0.2 - 2.5 mm ² , 12-24 AWG, 0.5-0.6 Nm			
Maximum switching voltage @ V_N	23 V DC	22 V DC	-	
Minimum switching voltage @ V_N	0.8 V DC	1 V DC	-	
Maximum switching current	-		5 A @ 30 V DC / 5 A @ 250 V AC	
Maximum current per channel	0.5 A		5 A	
Maximum current per module	2.0 A		20 A	
Differential voltage	1 V DC		-	
Nominal load				
Ohmic	12 W		600 W @ 24 Ω	
Lamp	12 W		-	
Inductive	12 VA (1.2 H)		-	
Motor inrush current			5 A @ 120 V AC / 5 A @ 240 V AC	
Motor full load current			1.5 @ 120 V AC / 0.9 @ 240 V AC	
Signal delay @ 20°C (excluding bounce)	-		10 ms	
Release time @ 20°C (excluding bounce)	-		4 ms	
Mechanical service life	-		10 x 10 ⁶ cycles	
Electrical service life (see Figure D-1)	-		100,000 cycles	
Operating frequency				
No load	100 Hz		300 operations per minute	
Rated load	100 Hz		30 operations per minute	
Overload response	Restart after removal of overload		Requires external protection	
Protection	Thermal fuse		Requires external protection	

D 2.5 Analog expansion module (Order No. 2701098)

General

Dimensions (H x W x D)	103 x 40 x 43 mm
Weight	98 g
Degree of protection	IP20
Connection method	D-SUB 9
Operating temperature range	-25...60°C
Storage temperature range	-25...85°C
Humidity (maximum) @25°C	90%

Analog inputs

Number	4
Connection method	Screw terminal, 0.2 - 2.5 mm ² , 12-24 AWG, 0.5-0.6 Nm
Nominal input voltage	24 V DC
Nominal input consumption	50 µA
Maximum input consumption	90 µA

Voltage input

Signal input voltage	0...10 V DC / -10...+10 V DC
Input resistance of voltage input	200 kΩ
Resolution	12 bit
Basic error limit	1.00%
Cut-off frequency (3 dB)	5 Hz

Current input

Signal input	0...20 mA / 4...20 mA
Input resistance of current input	120 Ω
Basic error limit	1.00%
Cut-off frequency (3 dB)	5 Hz

D 2.6 Analog expansion module (Order No. 2701040)

General

Dimensions (H x W x D)	103 x 40 x 43 mm
Weight	122 g
Degree of protection	IP20
Connection method	D-SUB 9
Nominal input voltage	24 V DC
Nominal input consumption	100 mA
Operating temperature range	-25...60°C
Storage temperature range	-25...85°C
Humidity (maximum) @25°C	90%

Analog inputs

Number	2
Connection method	Screw terminal, 0.2 - 2.5 mm ² , 12-24 AWG, 0.5-0.6 Nm

Voltage input

Signal input voltage	-10...+10 V DC
Input resistance of voltage input	200 kΩ
Resolution	12 bit
Basic error limit	1.00%
Cut-off frequency (3 dB)	5 Hz

Current input

Signal input	0...20 mA / 4...20 mA
Input resistance of current input	120 Ω
Basic error limit	1.00%
Cut-off frequency (3 dB)	5 Hz

Analog outputs

Number	2
Connection method	Screw terminal, 0.2 - 2.5 mm ² , 12-24 AWG, 0.5-0.6 Nm

Voltage output

Signal output voltage	0...10 V DC
Input resistance of voltage input	1000 Ω
Resolution	12 bit
Basic error limit	1.00%

Current output

Signal output	0...20 mA / 4...20 mA
Input resistance of current input	500 Ω
Basic error limit	1.00%

D 2.7 Temperature expansion module (Order No. 2701671)

General

Dimensions (H x W x D)	103 x 40 x 43 mm
Weight	110 g
Degree of protection	IP20
Connection method	D-SUB 9
Operating temperature range	0...60°C
Storage temperature range	-25...85°C
Humidity (maximum) @25°C	90%

Temperature inputs

Number	2
Connection method	Screw terminal, 0.2 - 2.5 mm ² , 12-24 AWG, 0.5-0.6 Nm
Design	Pt 100 DIN (alpha = 0.00385) Pt 100 SAMA (alpha = 0.00392) Pt 1000 (alpha = 0.00385)
Connection	2- or 3-wire
Input resistance	1 MΩ
Accuracy @ 25°C ambient (3-wire connection)	1% full scale
Thermocouple	
Sensor type	B, E, J, K, N, R, S, T
Connection	2-wire, shield
Accuracy	1.5% +1°C (CJC error)

Sensor types and accuracy

Sensor type	Minimum temperature	Maximum temperature	Accuracy
PT100 DIN	-200°C	850°C	±1% full scale
PT100 SAMA	-100°C	457°C	±1% full scale
PT1000	-200°C	850°C	±1% full scale
B	600°C	1800°C	±1.5% full scale +1°C (CJC error)
E	-100°C	1000°C	±1% full scale +1°C (CJC error)
J	-200°C	1200°C	±1% full scale +1°C (CJC error)
K	-100°C	1373°C	±1% full scale +1°C (CJC error)
N	-100°C	1300°C	±1% full scale +1°C (CJC error)
R	-50°C	1769°C	±1.5% full scale +1°C (CJC error)
S	-50°C	1769°C	±1.5% full scale +1°C (CJC error)
T	-100°C	400°C	±1.5% full scale +1°C (CJC error)

Outputs	
Output type	PNP
Number	4
Nominal power supply V_N	24 V DC
Connection method	Screw terminal, 0.2 - 2.5 mm ² , 12-24 AWG, 0.5-0.6 Nm
Maximum switching voltage @ V_N	24 V DC
Minimum switching voltage @ V_N	0.8 V DC
Maximum current per channel	0.5 A
Maximum current per module	2.0 A
Differential voltage	1 V DC
Nominal load	
Ohmic	7.2 W (80 Ω)
Lamp	7.2 W
Inductive	7.2 VA (1.2 H, 80 Ω)
Operating frequency	
No load	100 Hz
Rated load	100 Hz
Overload response	Restart after removal of overload
Protection	Thermal fuse

D 2.8 Operator Panel (Order No. 2701137)

General	
Dimensions (H x W x D)	46 x 76 x 31.5 mm
Weight	
Operator Panel	78 g
Mounting kit	112 g
Degree of protection	IP20
Connection method	Installs in base unit or can be remote mounted using optional mounting kit
Operating temperature range	-0...50°C
Storage temperature range	-0...60°C
Humidity (maximum) @ 50°C	90%

Supply voltages	
Typical current consumption	32 mA
Maximum current consumption	50 mA
Connection	Supplied by base via connector

Interface	
Communication method	Serial link
Connector type	2.54 mm socket or custom RJ45 cable

D 2.9 Operator Panel (Order No. 2701945)

General

Dimensions (H x W x D)	102 x 128 x 44.5 mm
Weight	228 g
Degree of protection	IP20
Mounting	Panel mount
Communication signal	RS-232
Connection	3-pin removable COMBICON
Operating temperature range	-0...50°C
Storage temperature range	-0...60°C
Humidity (maximum) @ 50°C	90%

Supply voltage

Typical current consumption	38 mA (24 V DC)
	71 mA (12 V DC)
Maximum current consumption	40 mA (24 V DC)
	75 mA (12 V DC)
Connection	3-pin removable COMBICON

D 2.10 Ethernet module (Order No. 2701124)

Interface

Communication method	Serial link
Connector type	2.54 mm socket or custom RJ45 cable

General

Dimensions (H x W x D)	103 x 40 x 43 mm
Weight	88 g
Degree of protection	IP20
Operating temperature range	-25...60°C
Storage temperature range	-25...85°C
Humidity (maximum) @ 25°C	90%

Interface

Communication method	Modbus Ethernet
Communication rate	10/100 Mbps
Number of simultaneous connections	6
Connection method	RJ45

D 2.11 GSM modem module (Order No. 2701344)

General

Dimensions (H x W x D)	103 x 80 x 60 mm
Weight	178 g
Degree of protection	IP20
Operating temperature range	-25...55°C
Storage temperature range	-25...85°C
Humidity (maximum) @ 25°C	90%

Supply voltages

Power supply (nominal)	12...24 V DC
Power permissible range (ripple included)	9.6...28.8 V DC
Current consumption - transmitting (typical)	
12 V	223 mA
24 V	120 mA
Current consumption - registered idle (typical)	
12 V	80 mA
24 V	50 mA
Connection	Screw terminal, 0.2 - 2.5 mm ² , 12-24 AWG, 0.5-0.6 Nm

Transmit data

Frequency	Quad band EGSM 850, 900, 1800, 1900 MHz
Power output	
850, 900 MHz	2 W
1800, 1900 MHz	1 W

Interface

SIM Card	6 pin, 3 V
Communication method	GSM
Antenna connection	SMA-F
Antenna requirements	
Power	>2 W
Gain	<3 dBi
Impedance	50 Ω
Recommended VSWR	≤2:1
Required VSWR	≤10:1

D 2.12 CDMA modem module (Order No. 2400428)

General

Dimensions (H x W x D)	103 x 80 x 60 mm
Weight	152 g
Degree of protection	IP20
Operating temperature range	-30...70°C
Storage temperature range	-30...85°C
Humidity (maximum) @ 25°C	90%

Supply voltages

Power supply (nominal)	12...24 V DC
Power permissible range (ripple included)	9.6...28.8 V DC
Current consumption - transmitting (typical)	
12 V	400 mA
24 V	210 mA
Current consumption - registered idle (typical)	
12 V	70 mA
24 V	30 mA
Connection	Screw terminal, 0.2 - 2.5 mm ² , 12-24 AWG, 0.5-0.6 Nm

Transmit data

Frequency	800/1900 MHz CDMA 1x RTT/1x EV-DO Rev. A
Power output	0.25 W

Interface

Communication method	CDMA
Antenna connection	SMA-F
Antenna requirements	
Power	>0.25 W
Gain	<5.12 dBi
Impedance	50 Ω
Recommended VSWR	≤2:1
Required VSWR	≤5:1

D 2.13 Base unit option module

General			
	2701179	2701182	2701195
Dimensions (H x W x D)	24.5 x 25.5 x 49 mm		
Weight	14 g	12 g	16 g
Degree of protection	IP20		
Operating temperature range	-25...60°C		
Storage temperature range	-25...85°C		
Humidity (maximum) @ 25°C	90%		
Interface			
	2701179	2701182	2701195
Communication method	Modbus RTU Serial RS-232	Modbus RTU Serial RS-485	USB with nanoNavigator driver
Communication rate	115 kbps		12 Mbps
Connection method	Slot #1		
Connector type	RJ12		USB
Recommended cable (Phoenix Contact Order No.)	2701234	2701073	2701247

D 2.14 RTC technical specifications (Order No. 2701153)

General	
Dimensions (H x W x D)	24.5 x 25.5 x 49 mm
Weight	12 g
Degree of protection	IP20
Operating temperature range	-25...60°C
Storage temperature range	-25...85°C
Humidity (maximum) @ 25°C	90%
Interface	
Communication method	Serial link
Connector type	Slot #2, 2.54 mm socket
Clock	
Type	Battery backed
Battery type	Lithium CR1225
Battery life	5 yr
Accuracy	2 s/day at 25°C 4.5 s/day at 60°C



The RTC module is required for proper operation of retentive memory with NLC-050... base units.

D 3 Conformance/approvals

Mechanical requirements

Vibration resistance according to IEC/EN 60068-2-6

5-10 Hz @ 3.55 mm, 10-150 Hz @ 2g

Shock resistance according to IEC/EN 60068-2-7

15g @ 11 ms all axis

EMC conformity according to 61000-6-2

ESD according to IEC/EN 61000-4-2

Criterion B
4 kV contact discharge
8 kV air discharge

Electromagnetic fields according to IEC/EN 61000-4-3

Criterion A
Field strength 10 V/M

Fast transient according to IEC/EN 61000-4-4

Criterion A
All interfaces: 1 kV
Criterion B
All interfaces : 2 kV

Surge voltage according to IEC/EN 61000-4-5

Criterion B
0.5 kV symmetrical

Conducted Interference IEC/EN 61000-4-6

Criterion A
Test voltage 10 V

Noise emissions according to 61000-6-4

EN 55011

Class A Industrial

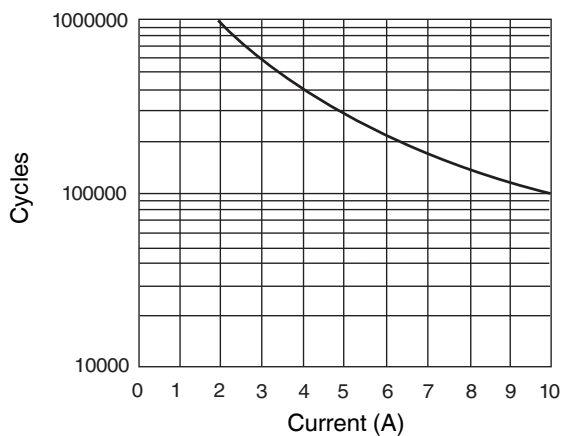

Figure D-1 Relay life expectancy @ 120 V AC

E Appendixes

E 1 List of figures

Section 1

Figure 1-1:	Typical system module layout	5
Figure 1-2:	Nanoline base unit type codes	6
Figure 1-3:	NLC-IO... expansion module type codes	7
Figure 1-4:	Nanoline Operator Panel (NLC-OP1-LCD-032-4X20)	8
Figure 1-5:	Nanoline Operator Panel (NLC-OP2-LCD-076-4X20)	9

Section 2

Figure 2-1:	Module locations	11
Figure 2-2:	Base unit release latch	12
Figure 2-3:	Rail placement	12
Figure 2-4:	Latch release for module removal	14
Figure 2-5:	Base unit slots	15
Figure 2-6:	RJ11 to D-SUB 9 cable for serial port connection	16
Figure 2-7:	RJ11 to open end for 4-wire RS-485 connections	17
Figure 2-8:	RJ-12 to open end for 2-wire RS-485 connection	17
Figure 2-9:	USB Type A to USB Type B cable for serial port connection	18
Figure 2-10:	Operator Panel location on the base unit	19
Figure 2-11:	Receptor Panel, display cable and remote Operator Panel	20
Figure 2-12:	Cutout dimensions for panel mounting	21
Figure 2-13:	Remote Operator Panel installation	21
Figure 2-14:	RJ12 to D-SUB 9 cable	22
Figure 2-15:	RJ45 to D-SUB 9 cable	23
Figure 2-16:	Remote Operator Panel installation	23
Figure 2-17:	Remote Operator Panel installation	24
Figure 2-18:	Power connections	25
Figure 2-19:	AC-type input connections (base unit shown)	26
Figure 2-20:	PNP-type input connection (base unit shown)	26
Figure 2-21:	NPN-type input connection (base unit shown)	26
Figure 2-22:	Digital NPN output connection (base unit shown)	27
Figure 2-23:	Digital PNP output connection (base unit shown)	27
Figure 2-24:	Analog input connection	28

Figure 2-25:	Analog output connection	28
Figure 2-26:	Relay output connection (base unit shown)	29
Figure 2-27:	Contact protective circuit (A), load protective circuit (B)	29
Figure 2-28:	PT100/PT1000 connection	32
Figure 2-29:	Thermocouple connection	32

Section 3

Figure 3-1:	Serial communication with PC (NLC-PC/SERIAL-CBL 1M cable shown)	36
Figure 3-2:	NLC-COM-ENET-MB1 communication expansion module	39
Figure 3-3:	“Display Definition” dialog box	42
Figure 3-4:	“Connection Details” dialog box with remote Modbus parameters	42
Figure 3-5:	“Connection Details” dialog box with direct connection parameters	43
Figure 3-6:	ModScan32 status window	44
Figure 3-7:	“Write Register” dialog box	44
Figure 3-8:	“Write Coil” dialog box	44
Figure 3-9:	RS-232 cable	45
Figure 3-10:	RS-485 cable	46
Figure 3-11:	“Serial port” dialog box for Nanoline to Nanoline communication	46
Figure 3-12:	“Configure RTC” dialog box	48

Section 4

Figure 4-1:	nanoNavigator 2 “Nanoline Configuration” dialog box showing configuration of NLC-050... system	57
Figure 4-2:	nanoNavigator 3 “Nanoline Configuration” dialog box showing configuration of NLC-055... system	58

Section 5

Figure 5-1:	<Shift> and <OK> keys	64
Figure 5-2:	<Shift> and p keys	64
Figure 5-3:	NLC-OP2-LCD-076-4X20	65
Figure 5-4:	Background color	65
Figure 5-5:	Timeout settings	66
Figure 5-6:	Serial port settings	66
Figure 5-7:	Opening screen in Run mode	67
Figure 5-8:	Project running, no display, and no expansion modules	67
Figure 5-9:	Project running, no display, and one expansion module	67

Figure 5-10:	Project running, no display, and three expansion modules	68
Figure 5-11:	Project stopped	68
Figure 5-12:	Project not running, no display	68
Figure 5-13:	System menu without application loaded	69
Figure 5-14:	System menu with application loaded	69
Figure 5-15:	“Monitor Data Items” menu	70
Figure 5-16:	Input List	70
Figure 5-17:	Force input options	71
Figure 5-18:	Output List	71
Figure 5-19:	Force output options	72
Figure 5-20:	Entering an Output/Flash Time	72
Figure 5-21:	Setting an output as retentive	73
Figure 5-22:	Removing the retentive setting	73
Figure 5-23:	Flag List	73
Figure 5-24:	Force flag options	74
Figure 5-25:	Setting a flag as retentive	74
Figure 5-26:	Removing the retentive setting	74
Figure 5-27:	Timer/counter list	75
Figure 5-28:	Timer/counter modification options	75
Figure 5-29:	Entering a timer/counter preset value	75
Figure 5-30:	Setting a timer/counter as retentive	76
Figure 5-31:	Removing the retentive setting	76
Figure 5-32:	Register List	76
Figure 5-33:	Entering a register value	77
Figure 5-34:	Setting a register as retentive	77
Figure 5-35:	Removing the retentive setting	77
Figure 5-36:	Stopping program execution	78
Figure 5-37:	Press 1 to start program execution	78
Figure 5-38:	Password Not Set	79
Figure 5-39:	Project name	79
Figure 5-40:	Setup menu	80
Figure 5-41:	Setup screen	80
Figure 5-42:	System information screen	80
Figure 5-43:	Set Date screen	81

Figure 5-44:	Set Time screen	81
Figure 5-45:	Memory module "Present"	81
Figure 5-46:	Memory Module menu with project running	82
Figure 5-47:	Memory Module menu with project stopped	82

Appendix A

Figure A-1:	Time-formatted data item type using binary format	89
Figure A-2:	Date-formatted data item type using binary format	89
Figure A-3:	Time-formatted data item type conversion using hex format	89

Appendix D

Figure D-1:	Relay life expectancy @ 120 V AC	121
-------------	--	-----

E 2 List of tables

Section 2

Table 2-1:	Circuit versions	30
Table 2-2:	Base unit LED indication.....	33

Section 3

Table 3-1:	Memory module behavior at start-up	39
Table 3-2:	NLC-COM-ENET-MB1 LED flash rates	40
Table 3-3:	Modbus TCP and RTU configuration parameters	41
Table 3-4:	RTC Error Messages.....	49

Appendix A

Table A-1:	Modbus function codes	86
Table A-2:	Coils 0-9999; Function codes 01, 05, 15	87
Table A-3:	Discrete inputs 10000-19999; Function code 02	87
Table A-4:	Input register 30000-39999; Function code 04	87
Table A-5:	Holding registers 40000-49999; Function codes 03, 06, 16, 23.....	87
Table A-6:	Coils 0-9999; Function codes 01, 05, 15 (NLC-055... units).....	88
Table A-7:	Discrete inputs 10000-19999; Function code 02 (NLC-055... units)....	88
Table A-8:	Input register 30000-39999; Function code 04 (NLC-055... units).....	88
Table A-9:	Holding registers 40000-49999; Function codes 03, 06, 16, 23 (NLC-055... units).....	88

Appendix B

Table B-1:	Base unit status flags.....	91
Table B-2:	Ethernet command flags.....	92
Table B-3:	Ethernet status flags	93
Table B-4:	Base unit status flags.....	94
Table B-5:	Ethernet command Flags.....	95
Table B-6:	Ethernet status flags	96

Appendix C

Table C-1:	Hot-swappable components.....	97
Table C-2:	Suggested pre-commissioning checklist	98
Table C-3:	Power up and functionality checklist	99
Table C-4:	Output points list.....	100
Table C-5:	Input points list.....	101
Table C-6:	Analog points list	102

E 3 Index

A

Analog inputs	28
Analog outputs	28

B

Base unit	6
LEDs	33
Option module	7, 36, 37
Slots	15
Type codes	6

C

Commissioning	51
Communication	35
Ethernet	39
Modbus	41
nanoNavigator	35
RS-232	36
RS-485	37
Serial	35
USB	37
Communication expansion module	7, 39
Communications watchdog	40
Components	5
Base unit option modules	5
Communication expansion modules	5
I/O expansion modules	5
Operator Panel	5, 63
Connections	24
Analog inputs	28
Analog outputs	28
Digital inputs	26
Digital outputs	27
Power	25
Relay outputs	29
RS-232	36
RS-485	37
Serial	35
Temperature inputs	32
USB	37

D

Data entry	63, 65
DB-9	7
Digital inputs	26
Digital outputs	27

E

Error message	49
Ethernet	7
Ethernet network	39
Expansion module	
Communication	7
I/O	6
Type codes	7

F

Fault	49
Field equipment commissioning	56
Field wiring checks	53

I

I/O expansion module	6, 67
Input	
Analog	28
Connection	24
Digital	26
Temperature	32
Installation checks	52
Installing modules	11

L

LEDs	
Base unit	33
Ethernet module	40

M

Memory module	37
Start-up behavior	38
Modbus communication	41
Modbus holding registers	83, 86
ModScan32	41
Module installation	11
Monitor mode	69

N

nanoNavigator	10, 63
Communication	35
Operating system	10
Network	39
NS35	5

O

Operator Panel	8, 18
Data entry	63, 65
Local installation	19
Remote installation	19
Usage	63
Option module	7, 37
Slots	15
Output	
Analog	28
Connection	24
Digital	27
Relay	29

P

Password	79
PLC	5
Power	24, 25
Power connection	25
Power up and functionality checks	55
Programming software	10
Project status	67

R

Real-time clock	47
Receptor Panel	19
Relay outputs	29
Removing modules	13
RJ45	7
RS-232	36
RS-485	37
RTC Faults	49
Run mode	63, 67

S

Serial connections	35
Slots	
Base Unit	15
Special key combinations	64, 65
Start-up behavior	38

T

Temperature inputs	32
Troubleshooting	69
Ethernet	40
Opening message screen	67, 68
Type codes	
Base unit	6
Expansion module	7

U

USB	37
-----------	----