

DO NOT SCALE FROM THIS PRINT

DESIGNED & DIMENSIONED IN MILLIMETERS [INCHES]

QSFP-PF-XX-X

TERMINATION
-PF: PRESS FIT

STYLE
(LEAVE BLANK FOR STANDARD)
*-F: FLYOVER

OPTION
-01: WITHOUT HEAT SINK
-02: WITH HEAT SINK ASSEMBLED (SEE NOTE 4)
-03: WITH HEAT SINK AND CLIP PACKAGED SEPARATELY

* = NOT RELEASED

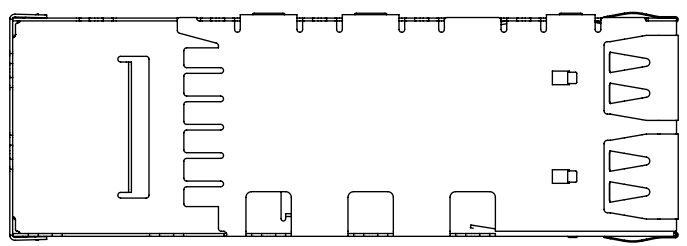
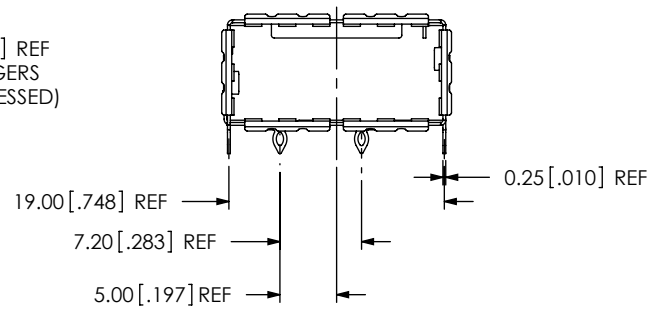
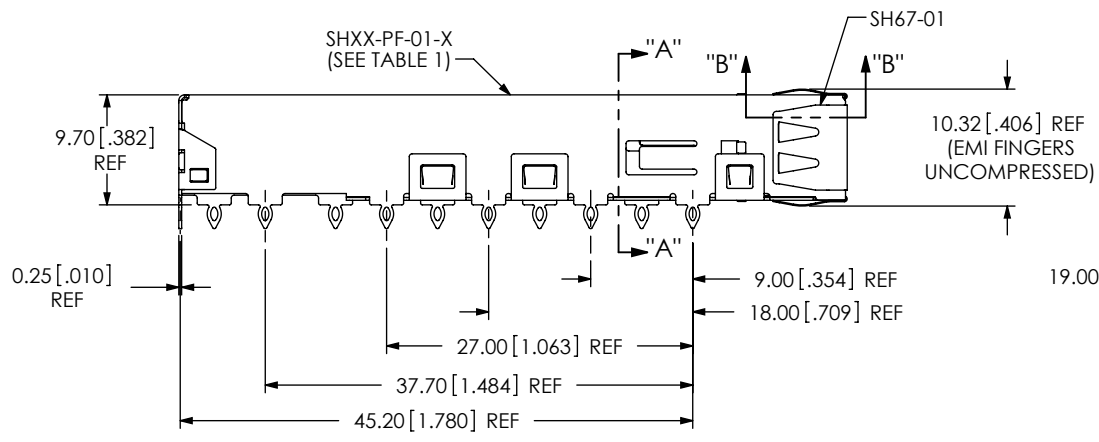
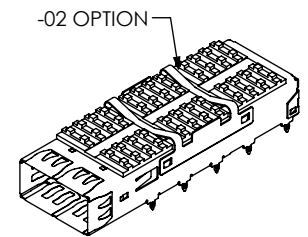
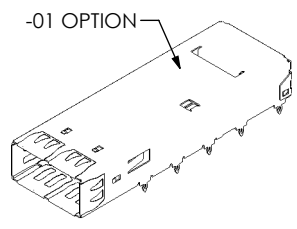
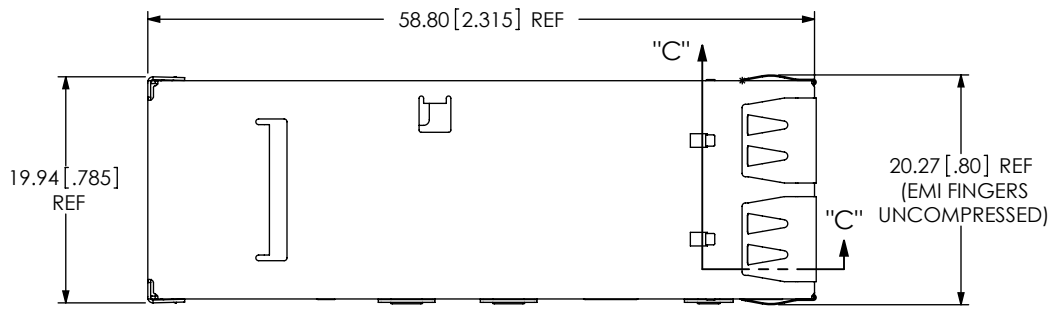

TABLE 1		
OPTION	STYLE	SHXX-PF-01-X
-01	STANDARD	SH59-PF-01-X
	*-F	SH81-PF-01-X
-02	STANDARD	SH59-PF-02-X
	*-F	SH81-PF-02-X
-03	STANDARD	SH59-PF-02-X
	*-F	SH81-PF-02-X

(* = NOT RELEASED)

FIG 1
QSFP-PF-01 SHOWN

NOTES:

1. © REPRESENTS A CRITICAL DIMENSION.
2. MINIMUM PUSHOUT FORCE: 1.11N [.25 LB]
3. ALL PARTS MUST BE PACKAGED IN TUBES.
4. HEAT SINK MUST BE REMOVED PRIOR TO TERMINATION TO PRINTED CIRCUIT BOARD.
5. SEE QSFP-PF APPLICATION FOR ADDITIONAL TERMINATION INSTRUCTIONS.
6. -F STYLE TO USE SAME TUBE & PLUG AS STANDARD.

UNLESS OTHERWISE SPECIFIED, DIMENSIONS ARE IN MILLIMETERS. TOLERANCES ARE:
DECIMALS ANGLES
X.X: ±0.3 [.01] 2°
X.XX: ±0.13 [.005]
X.XXX: ±0.051 [.0020]

PROPRIETARY NOTE
THIS DOCUMENT CONTAINS CONFIDENTIAL AND PROPRIETARY INFORMATION AND ALL DESIGN, MANUFACTURING, REPRODUCTION, USE, PATENT RIGHTS AND SALES RIGHTS ARE EXPRESSLY RESERVED BY SAMTEC, INC. THIS DOCUMENT SHALL NOT BE DISCLOSED, IN WHOLE OR PART, TO ANY UNAUTHORIZED PERSON OR ENTITY NOR REPRODUCED, TRANSFERRED OR INCORPORATED IN ANY OTHER PROJECT IN ANY MANNER WITHOUT THE EXPRESS WRITTEN CONSENT OF SAMTEC, INC.

MATERIAL: DO NOT SCALE DRAWING SHEET SCALE: 1.5:1
CAGE: COPPER ALLOY
CLIP: STAINLESS STEEL
EMI FINGERS: STAINLESS STEEL
HEAT SINK: ALUMINUM ALLOY

samtec
520 PARK EAST BLVD, NEW ALBANY, IN 47150
PHONE: 812-944-6733 FAX: 812-948-5047
e-Mail: info@SAMTEC.com code 53322

DESCRIPTION:
QSFP CAGE

DWG. NO. QSFP-PF-XX-X

BY: VICKY Z 09/07/2010 SHEET 1 OF 4

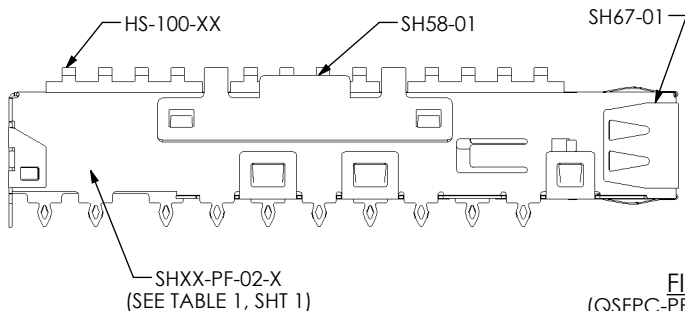
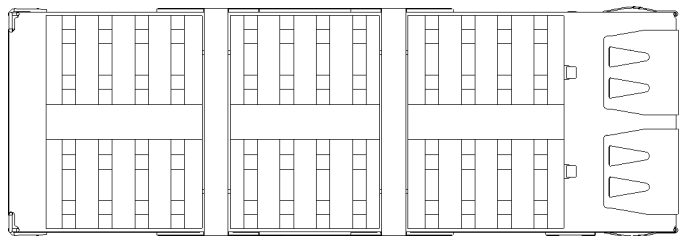
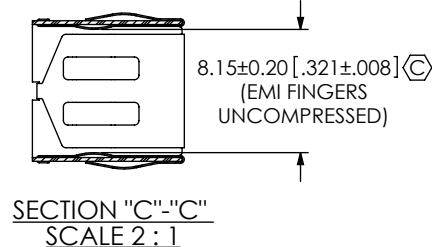
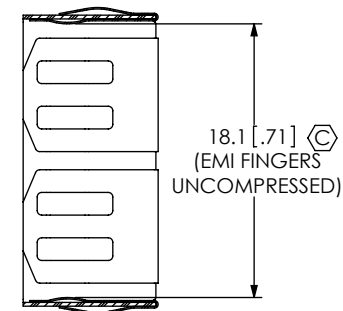
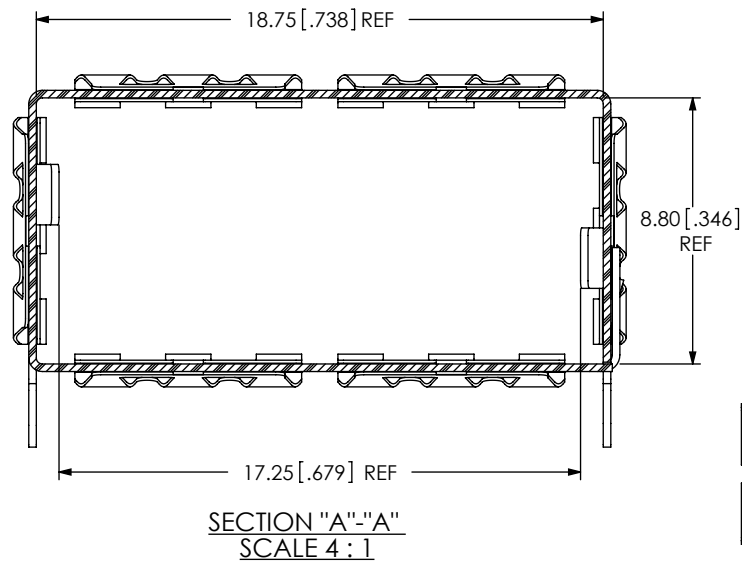
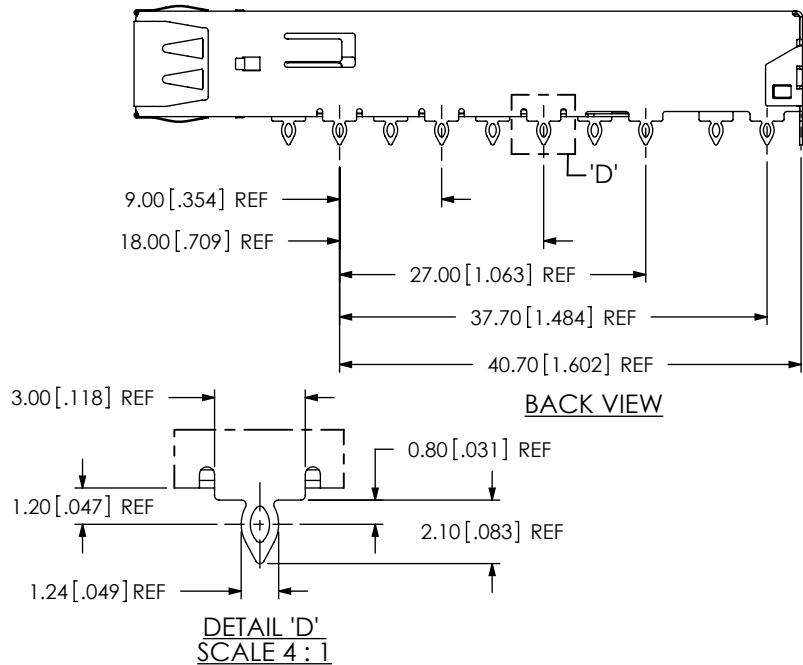
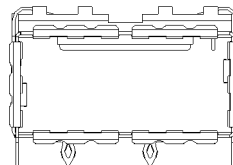

FIG 2
(QSFP-PF-02 SHOWN)
(SAME AS FIG 1, EXCEPT AS SHOWN)



PROPRIETARY NOTE
THIS DOCUMENT CONTAINS CONFIDENTIAL AND PROPRIETARY INFORMATION AND ALL DESIGN, MANUFACTURING, REPRODUCTION, USE, PATENT RIGHTS AND SALES RIGHTS ARE EXPRESSLY RESERVED BY SAMTEC, INC. THIS DOCUMENT SHALL NOT BE DISCLOSED, IN WHOLE OR PART, TO ANY UNAUTHORIZED PERSON OR ENTITY NOR REPRODUCED, TRANSFERRED OR INCORPORATED IN ANY OTHER PROJECT IN ANY MANNER WITHOUT THE EXPRESS WRITTEN CONSENT OF SAMTEC, INC.

DO NOT SCALE DRAWING

SHEET SCALE: 1.5:1

samtec

520 PARK EAST BLVD, NEW ALBANY, IN 47150
PHONE: 812-944-6733 FAX: 812-948-5047
e-Mail: info@SAMTEC.com code 55322

DESCRIPTION:
QSFP CAGE

DWG. NO.
QSFP-PF-XX-X

BY: VICKY Z 09/07/2010 SHEET 2 OF 4

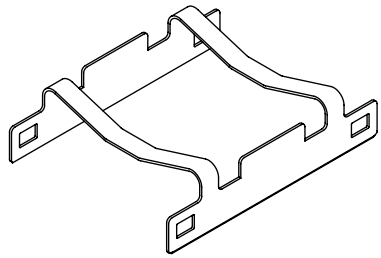

SH58-01

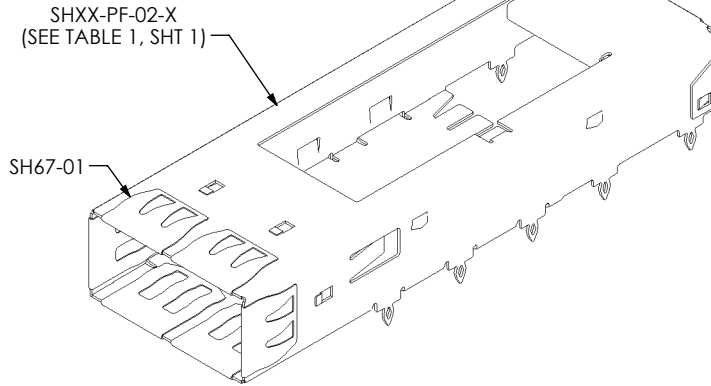

QSFP-CF-03

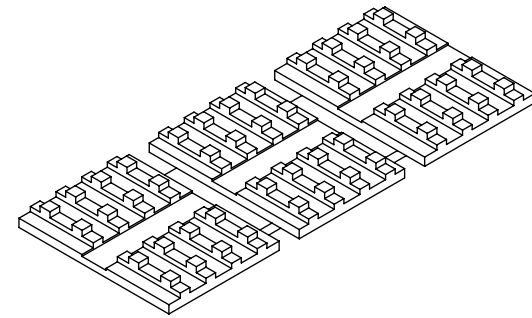

HS-100-01

FIG 3
(QSFP-CF-03 SHOWN)
(SAME AS FIG 1, EXCEPT AS SHOWN)

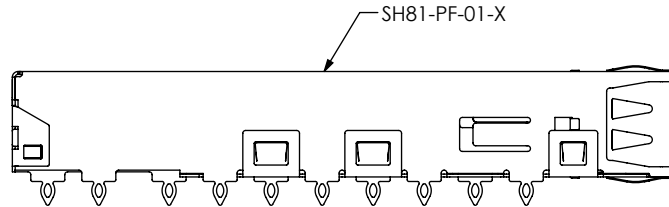
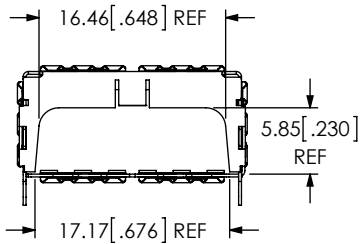
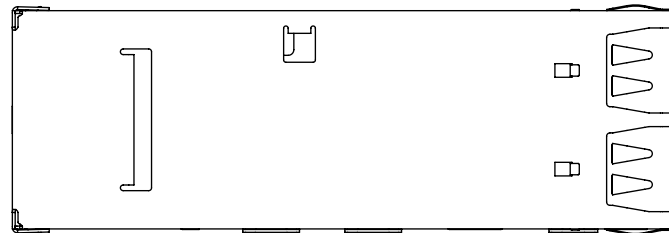

FIG 4
QSFP-CF-01-F SHOWN
(NOT RELEASED)
(SAME AS FIG 1, EXCEPT AS SHOWN)
(SEE NOTE 6)

PROPRIETARY NOTE
THIS DOCUMENT CONTAINS CONFIDENTIAL AND PROPRIETARY INFORMATION AND ALL DESIGN, MANUFACTURING, REPRODUCTION, USE, PATENT RIGHTS AND SALES RIGHTS ARE EXPRESSLY RESERVED BY SAMTEC, INC. THIS DOCUMENT SHALL NOT BE DISCLOSED, IN WHOLE OR PART, TO ANY UNAUTHORIZED PERSON OR ENTITY NOR REPRODUCED, TRANSFERRED OR INCORPORATED IN ANY OTHER PROJECT IN ANY MANNER WITHOUT THE EXPRESS WRITTEN CONSENT OF SAMTEC, INC.

DO NOT SCALE DRAWING

SHEET SCALE: 1.5:1



520 PARK EAST BLVD, NEW ALBANY, IN 47150
PHONE: 812-944-6733 FAX: 812-948-5047
e-Mail info@SAMTEC.com code 55322

DESCRIPTION:

QSFP CAGE

DWG. NO.

QSFP-CF-XX-X

BY: VICKY Z

09/07/2010

SHEET 3 OF 4

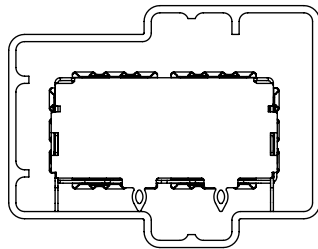

QSFPC-PF-01
(SEE NOTES 3 & 6)

TUBE: PT-RPB1001
PLUG: TP-04

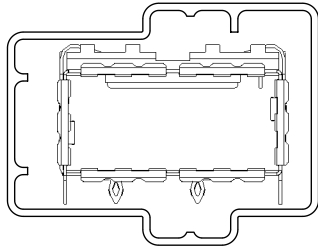

QSFPC-PF-02
(SEE NOTES 3 & 6)

TUBE: PT-RPB1001
PLUG: TP-04

PACKAGING VIEWS

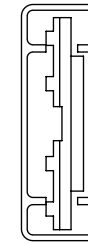

HEAT SINK
HS-100-01
(SEE NOTE 3)

TUBE: PT-1-24-14-29
PLUG: TP-03

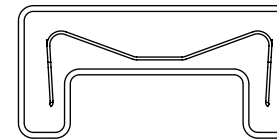

SHIELD
SH58-01
(SEE NOTE 3)

TUBE: PT-1-24-01-34
PLUG: TP-07

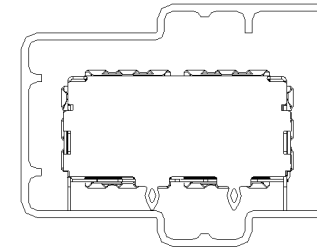

QSFPC-PF-03
(SEE NOTES 3 & 6)

TUBE: PT-RPB1001
PLUG: TP-04

PROPRIETARY NOTE
* THIS DOCUMENT CONTAINS CONFIDENTIAL AND PROPRIETARY INFORMATION AND ALL DESIGN, MANUFACTURING, REPRODUCTION, USE, PATENT RIGHTS AND SALES RIGHTS ARE EXPRESSLY RESERVED BY SAMTEC, INC. THIS DOCUMENT SHALL NOT BE DISCLOSED, IN WHOLE OR PART, TO ANY UNAUTHORIZED PERSON OR ENTITY NOR REPRODUCED, TRANSFERRED OR INCORPORATED IN ANY OTHER PROJECT IN ANY MANNER WITHOUT THE EXPRESS WRITTEN CONSENT OF SAMTEC, INC. *



520 PARK EAST BLVD, NEW ALBANY, IN 47150
PHONE: 812-944-6733 FAX: 812-948-5047
e-Mail: info@SAMTEC.com code 55322

SHEET SCALE: 1.5:1

DESCRIPTION: QSFP CAGE

DWG. NO. QSFPC-PF-XX-X

BY: VICKY Z 09/07/2010 SHEET 4 OF 4