

# Pneumatics

Switching, automation systems, directional control in industrial and explosive atmospheres 

## Overview



■ Switching



■ Control systems



■ Directional control

[www.crouzet.com](http://www.crouzet.com)





Contents

Editorial

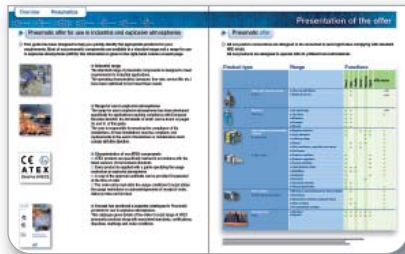

■ Presentation of the offer P. 4-5



■ Overview of the offer P. 6-29

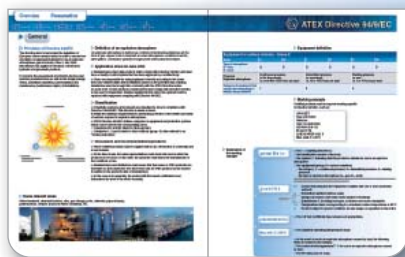

■ ATEX Directive 94/9/EC P. 30-31

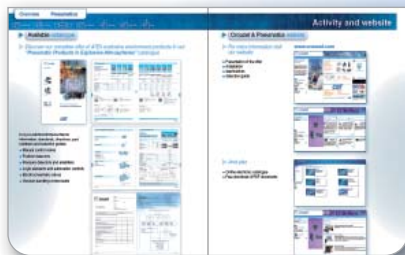

■ Catalogues & websites P. 32-33



■ Sales and technical support P. 36



For over 50 years, Crouzet has established a reputation for providing micro-control products, micro-motors and position sensors. Read on to discover Crouzet's complete offer of Pneumatic products for industrial and explosive atmospheres.

Always one step ahead of market trends and customer requirements, Crouzet is continually developing its range of both standard and customised automation components and solutions to cover all the latest commercial and industrial applications and meet the needs expressed by manufacturers of automated equipment and machinery.

Throughout the world, Crouzet the adaptation specialist provides you with technical and industrial expertise to ensure seamless integration, whatever the equipment environment or operating requirements of the machine.

CST (Custom Sensors & Technologies) Business Unit incorporates the companies BEI, Crouzet, Crydom & Kavlico. In addition to the Pneumatic solutions contained in this catalogue, CST also offers a complete range of detection, motorisation and micro-control products and solutions. This new organisation means even better service and technical choices for our customers.

Crouzet's Quality Control System has integrated environmental management into its processes. The production sites are ISO 9001 and ISO 14001 certified.



Eco-design is central to the company's "Offer Creation Process", the aim of which is to design products and services that correspond as closely as possible to customers' requirements and reduce their environmental impact throughout their life cycle.

All Crouzet products are fully compliant with the RoHS Directive.





# Pneumatic expertise

## ► Expertise - for all your applications

### ■ Crouzet's Pneumatic expertise

provides you with an offer to meet all your automation system requirements, including systems for explosive atmospheres.

The quality of the Pneumatic components is based on a rigorous organisation which meets all current European and international directives, standards and approvals.

■ **All our products are fully compliant** with the RoHS Directive and embody an eco-design concept. The Pneumatic offer is the result of the implementation of Crouzet applications and expertise:

- **Listening to and analysing** your requirements
- **Expertise** in the associated applications: mechanical, electronic, sensors, etc.
- **Prototyping and industrialisation**
- **Tests**
- **Standardisation and certification** (IEC, EN, UL-CSA, ATEX, etc.)
- **Equipment** which is responsive and effective
- **International logistics** and after sales support

■ **Crouzet has developed broad expertise** in ensuring that your specific needs are taken into account. Thanks to this expertise, we are continuously developing our standard products to create solutions tailored to your requirements.

For more application examples, go to the Pneumatics section on our website: [www.crouzet.com](http://www.crouzet.com)

[www.crouzet.com](http://www.crouzet.com)

## ► Examples of applications:

### Medical mattress

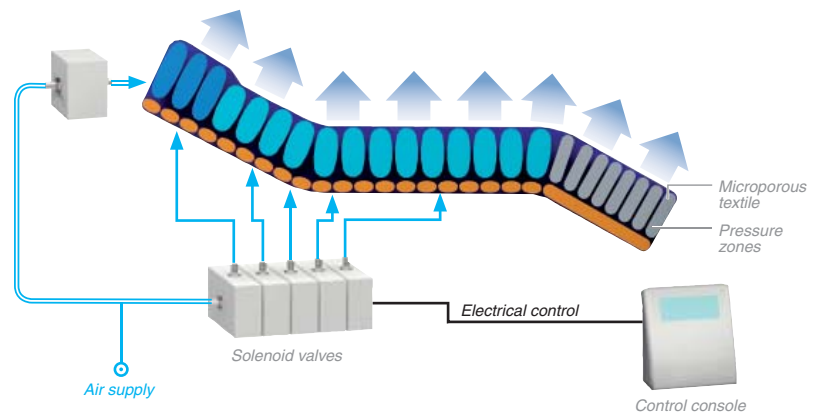

### Textile machine

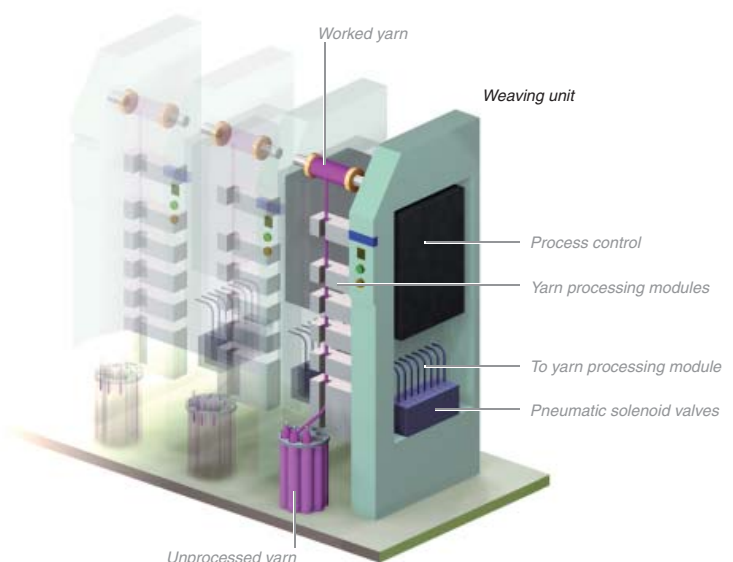

### Industrial valve

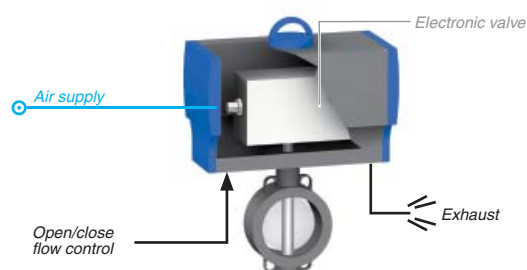

Pneumatic actuators for quarter-turn or proportional taps and valves allow open/close commands and flow rate changes to be automated. The pneumatic actuating cylinder is operated by means of an air distributor valve built into the valve body and controlled by a solenoid valve.



► Pneumatic offer for use in industrial and explosive atmospheres

► This guide has been designed to help you quickly identify the appropriate products for your requirements. Most of our pneumatic components are available in a standard range and a range for use in explosive atmospheres (ATEX): this information is given in the right-hand column on each page.



■ Industrial range

The standard range of pneumatic components is designed to meet requirements for industrial applications.

The operating characteristics (pressure, flow rate, service life, etc.) have been optimised to best meet these needs.



■ Range for use in explosive atmospheres

The range for use in explosive atmospheres has been developed specifically for applications requiring compliance with European Directive 94/9/EC, the full details of which can be found on pages 30 and 31 of this guide.

The user is responsible for ensuring the compliance of his installations. All new installations must be compliant, and replacements in the event of breakdown or maintenance must comply with this directive.



■ Characteristics of our ATEX components

- ATEX products are specifically marked in accordance with the latest versions of harmonised standards
- Every product is supplied with a guide specifying the usage restrictions in explosive atmospheres
- A copy of the approval certificate can be provided if requested at the time of order
- The order entry must state the usage conditions Crouzet states the usage restrictions on acknowledgements of receipt of order, delivery notes and invoices



■ Crouzet has produced a separate catalogue for Pneumatic products for use in explosive atmospheres.







This catalogue gives details of the entire Crouzet range of ATEX pneumatic products along with associated standards, certifications, directives, markings and order conditions.

# Presentation of the offer

## Pneumatic offer

▶ All our push-in connections are designed to be connected to semi-rigid tubes complying with standard NFE 49100.

All our products are designed to operate with 50 µ filtered non lubricated air.

Product type	Range	Functions						
		Detect	Pilot	Amplify	Restrict	Memorise	Signal	ATEX version
 <p>Manually operated valves P. 6-7-8</p>	■ Flow rate 200 NI/min		■					✓ (1)
	■ Button Ø 22 mm		■					✓ (1)
 <p>Detectors P. 9-10-11</p>	■ On valve body	■	■					✓ (1)
	■ Low force	■	■					✓
	■ Miniature	■	■					
	■ Compact	■	■					
	■ Special	■	■					
 <p>Logic elements and automation controls P. 12-13-14-15</p>  <p>P. 16-17-18-19</p>	■ Sequencer modules	■			■	■		✓
	■ Logic elements	■				■	■	✓
	■ Latching relays					■		✓
	■ Timers		■		■	■		✓
	■ Flow restrictors, capacities, non-return				■			✓
	■ Sub-bases							✓
	■ Pressure switches	■					■	✓
	■ Pressure regulators	■					■	✓
	■ Vacuum switches	■					■	✓
	■ Leak detector relays	■	■	■			■	✓
	■ Amplifiers	■	■	■				✓
	■ Indicators	■					■	✓
	■ Counters	■				■		
	■ Two-hand controls	■	■					
	■ Vacuum generators	■	■					✓
 <p>Valve modules P. 20-21-22-23-24-25-26-27</p>	■ Miniature solenoid valves for valve modules		■					✓
	■ Sub-bases							✓
	■ Stand-alone miniature solenoid valves			■				✓
	■ Valve modules			■	■			✓
	■ Pre-assembled modules				■			✓
 <p>Simulation kits P. 28</p>	■ Standard	■	■	■	■	■		
	■ Specific	■	■	■	■	■		

(1) **Note:** Manual control valves are deemed to be simple slow-moving components, without any hot surfaces, and are not subject to ATEX Directive 94/9/EC. They can be integrated in devices and equipment conforming to the requirements of this Directive without adversely affecting conformity. Nonetheless, parts of these components made of polymer can have an electrostatic charge and the user must take account of these charges.



▶ Valves, flow rate 200 NI/min

**Common characteristics**

- Supply pressure: 2 - 8 bar
- Connection: push-in for ext. tube Ø 4 mm
- Operating temperature: -5°C → +50°C

V1	Products	Part number	Function	Outputs	Fixing	Environment	
						Industrial	ATEX explosive
<b>3/2 valves</b>							
		81280010	NO	Side	Frame	✓	✓ (1)
		81280510	NC	Side	Frame	✓	✓ (1)
		81281010	NO	Rear	Frame	✓	✓ (1)
		81281510	NC	Rear	Frame	✓	✓ (1)
		81282010	NO	Side	Clips	✓	✓ (1)
		81282510	NC	Side	Clips	✓	✓ (1)
		81283010	NO	Side	Nut	✓	✓ (1)
		81283510	NC	Side	Nut	✓	✓ (1)

▶ Manually operated valves, flow rate 200 NI/min

**Common characteristics**

- Supply pressure: 2 - 8 bar
- Connection: push-in for ext. tube Ø 4 mm
- Operating temperature: -5°C → +50°C

▶ **To build your manually operated valves:**

- 1- Choose the valve body from the table **V1** above
- 2- Choose the control accessory from the table below

Products	Part number	Actuator	Control	Shape	Colour	Modularity	Environment	
							Industrial	ATEX explosive
<b>Control accessories</b>								
	79455614	Single plunger		Round	Red	1 valve maximum	✓	✓ (1)
	79455615	Single plunger		Round	Black	1 valve maximum	✓	✓ (1)
	79455616	Single plunger		Square	Red	1 valve maximum	✓	✓ (1)
	79455617	Single plunger		Square	Black	1 valve maximum	✓	✓ (1)
	79455618	Double plunger		Round	Red/black	1 valve maximum	✓	✓ (1)
	79455619	Double plunger		Square	Red/black	2 valves maximum	✓	✓ (1)
	79455628	Lever, 3 positions, manual return	Simultaneous		Red	2 valves maximum (*)	✓	✓ (1)
	79455629	Lever, 3 positions, manual return	Simultaneous		Black	2 valves maximum (*)	✓	✓ (1)
	79455630	Lever, 3 positions, automatic return	Simultaneous		Red	2 valves maximum (*)	✓	✓ (1)
	79455631	Lever, 3 positions, automatic return	Simultaneous		Black	2 valves maximum (*)	✓	✓ (1)

(\*) Can be converted to 2 positions on request.  
NO and NC functions can be combined.

(1) Manual control valves are deemed to be simple slow-moving components, without any hot surfaces, and are not subject to ATEX Directive 94/9/EC. They can be integrated in devices and equipment conforming to the requirements of this Directive without adversely affecting conformity. Nonetheless, parts of these components made of polymer can have an electrostatic charge and the user must take account of these charges.



## Manually operated valves for button Ø 22 mm

### Common characteristics















■ Flow rate: 90 NI/min

■ Supply pressure: 0 - 10 bar

■ Operating temperature: -10°C → +60°C

Product	Part number	Type	Function	Connection	Environment	
					Industrial	ATEX explosive 
<b>Valves</b>						
	89544001	3/2 valves	NO	Push-in for ext. tube Ø 4 mm	✓	✓ (1)
	89544201	3/2 valves	NO	Gas 1/8	✓	✓ (1)
	89544501	3/2 valves	NC	Push-in for ext. tube Ø 4 mm	✓	✓ (1)
	89544701	3/2 valves	NC	Gas 1/8	✓	✓ (1)
	89545005	3/2 valves (*)	1 NO	Push-in for ext. tube Ø 4 mm	✓	✓ (1)
	89545105	3/2 valves (*)	1 NC	Push-in for ext. tube Ø 4 mm	✓	✓ (1)
	89545205	3/2 valves (*)	2 NC	Push-in for ext. tube Ø 4 mm	✓	✓ (1)
	89545305	3/2 valves (*)	1 NC + 1 NO	Push-in for ext. tube Ø 4 mm	✓	✓ (1)
	24679701	Adaptor Ø 22 mm			✓	✓ (1)

(\*) Valve supplied with adaptor **part no. 24679701**.

Product	Part number	Type	Diagram	Environment	
				Industrial	ATEX explosive 
<b>Pushbuttons</b>					
	24679127	Flush-mounted momentary contact pushbutton, black		✓	✓ (1)
	24679128	Flush-mounted momentary contact pushbutton, green		✓	✓ (1)
	24679129	Flush-mounted momentary contact pushbutton, red		✓	✓ (1)
<b>Mushroom pushbuttons</b>					
	24679171	Push/turn mushroom button, red		✓	✓ (1)
	24679172	Momentary contact mushroom button, black		✓	✓ (1)
	24679173	Momentary contact mushroom button, red		✓	✓ (1)
<b>Toggles</b>					
	24679174	Toggle, black, 2 positions		✓	✓ (1)
	24679175	Lever toggle, black, 2 positions		✓	✓ (1)
	24679176	Toggle, black, 3 positions		✓	✓ (1)
	24679177	Lever toggle, black, 3 positions		✓	✓ (1)
	24679178	Return toggle, black, 3 positions		✓	✓ (1)
	24679179	Return toggle, black, 3 positions		✓	✓ (1)
	24679180	Key toggle, 2 positions - removal at 0		✓	✓ (1)
	24679181	Key toggle, 3 fixed positions - removal at 0		✓	✓ (1)
	24679182	Key toggle, 3 positions, return to centre, removal at 0		✓	✓ (1)

(1) Manual control valves are deemed to be simple slow-moving components, without any hot surfaces, and are not subject to ATEX Directive 94/9/EC. They can be integrated in devices and equipment conforming to the requirements of this Directive without adversely affecting conformity. Nonetheless, parts of these components made of polymer can have an electrostatic charge and the user must take account of these charges.





► Applications

► Marking control system

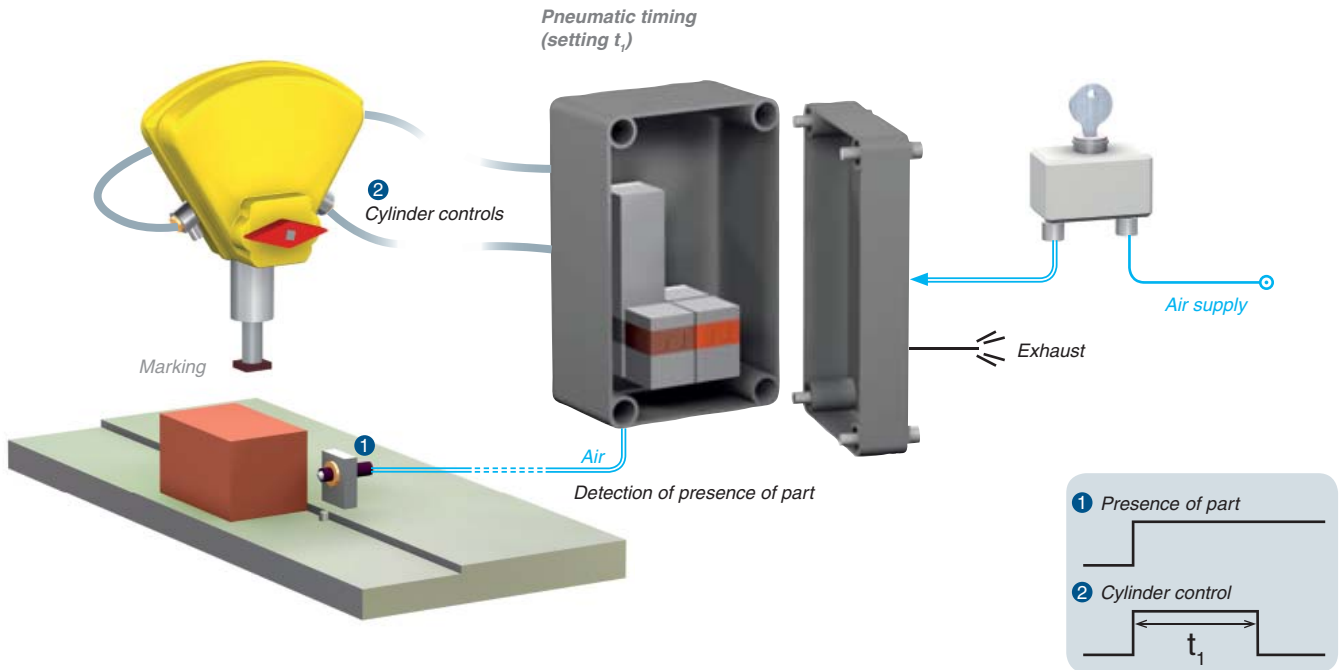

► Semi-automatic resin filling system, with anti-drip control

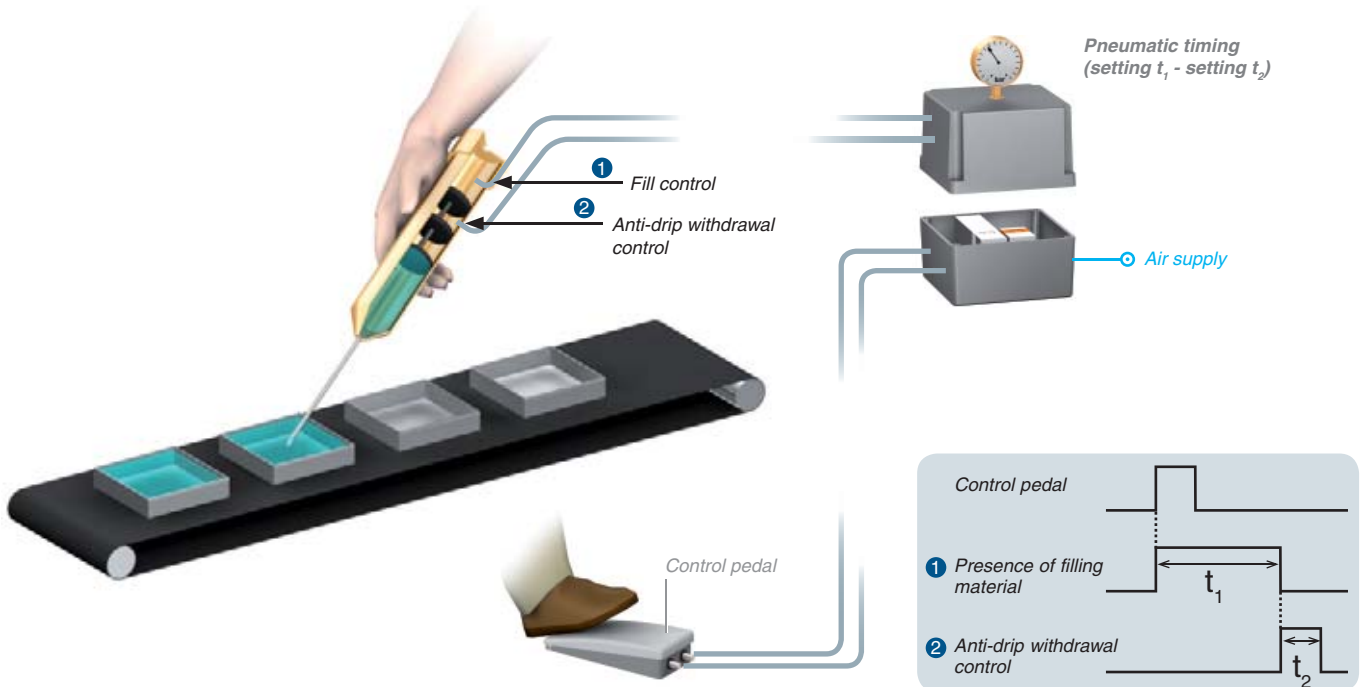





## ▶ Detectors on valve bodies

### Common characteristics

- Flow rate: 200 NI/min
- Outlet: semi-rigid tube, external Ø 4 mm
- Supply pressure: 2 - 8 bar
- Operating temperature: -5°C → +50°C

### ▶ To build your detector:

- 1- Choose the valve body from the table **v1** on page 6
- 2- Choose the control accessory from the table below

Products	Part number	Actuator	Environment	
			Industrial	ATEX explosive 
	79455632	Short straight lever	✓	
	79455633	Ball	✓	
	79455634	Idle-return roller	✓	
	79455635	Short roller	✓	
	79455636	Single plunger on threaded barrel Ø 16 mm	✓	
	79455637	Roller plunger on threaded barrel Ø 16 mm	✓	

## ▶ Applications

- 1 Supply and positioning of part
- 2 Insertion of part
- 3 Detection of part
- 4 Marking

### ▶ Automatic assembly system

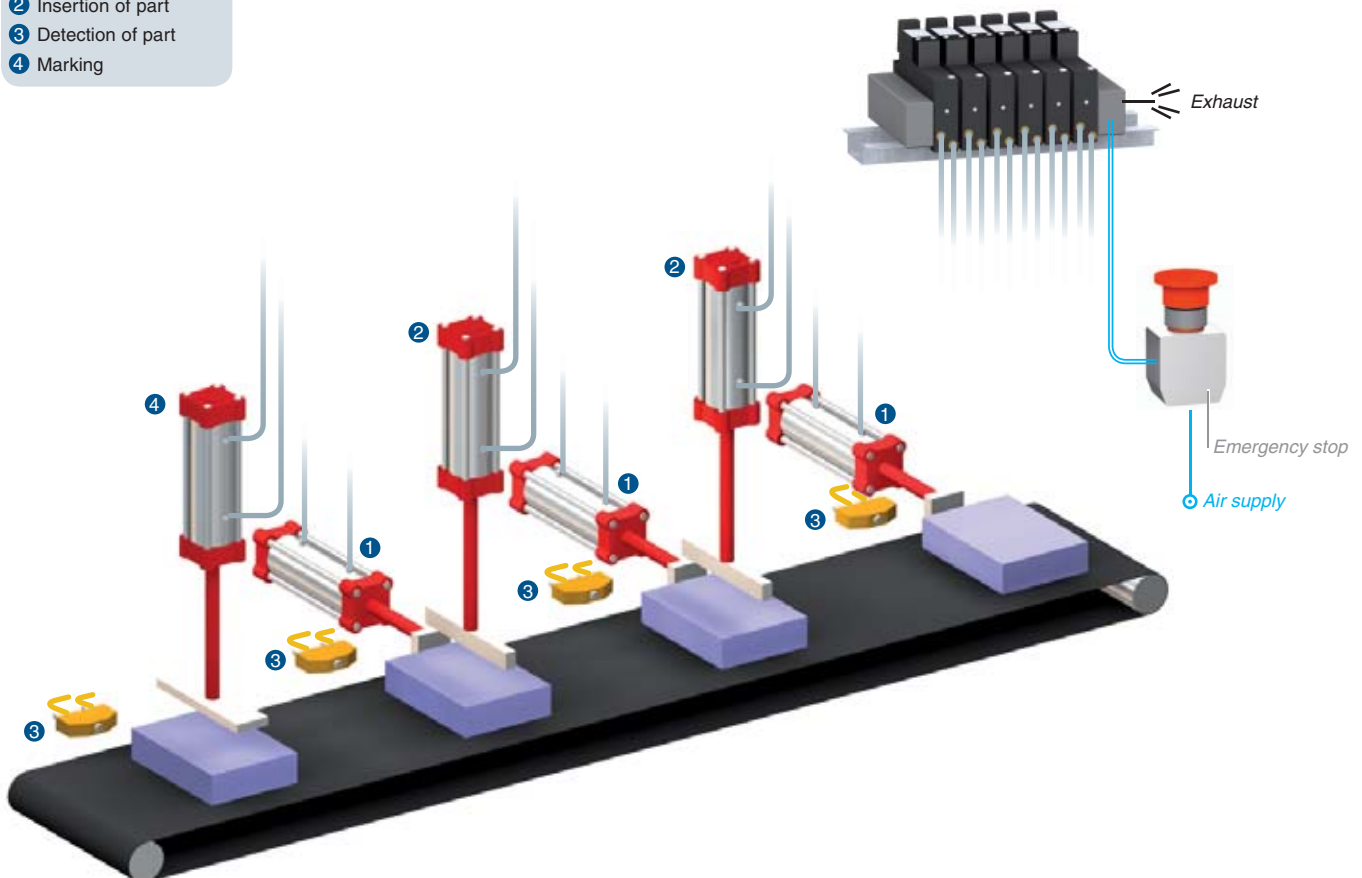



► Detectors

Product	Part number	Type	Function	Type of control
<b>Low force</b>				
	81290001	DDP <sup>(3)</sup> 3/2 - V3 - actuating force < 0.5 N	NC	Exposed plunger
	81290501	DDP <sup>(3)</sup> 3/2 - V3 - actuating force < 0.5 N	NO	Exposed plunger
	81290901	DDP <sup>(3)</sup> 3/2 - V3 - actuating force < 0.5 N	NC	Exposed plunger
<b>Accessories</b>				
	70507524	Lever 161A R = 25.4 for detector V3		Flat lever
	70507529	Lever 161E R = 24.1 for detector V3		Roller
<b>ATEX explosive atmosphere</b>				
		DDP <sup>(3)</sup> 3/2 - V3 - actuating force < 0.5 N	NC	
		DDP <sup>(3)</sup> 3/2 - V3 - actuating force < 0.5 N	NO	
<b>Miniature</b>				
	81921501	DDP <sup>(3)</sup> 3/2 actuating force < 18 N	NC	Single plunger
	81921505	DDP <sup>(3)</sup> 3/2 threaded barrel Ø M12 actuating force < 21 N	NC	Single plunger
	81921601	DDP <sup>(3)</sup> 3/2 actuating force < 18 N	NC	Single plunger
	81921701	DDP <sup>(3)</sup> 3/2	NC	Plastic roller
	81921702	DDP <sup>(3)</sup> 3/2	NC	Roller-bearing roller
	81921707	DDP <sup>(3)</sup> 3/2	NC	Plastic idle-return roller
	81921712	DDP <sup>(3)</sup> 3/2	NC	Roller-bearing idle-return roller
	81921714	DDP <sup>(3)</sup> 3/2 exhaust with barb connector	NC	Roller-bearing roller
	81921716	DDP <sup>(3)</sup> 3/2 Viton® O-ring	NC	Plastic roller
	81921717	DDP <sup>(3)</sup> 3/2 exhaust with barb connector	NC	Roller-bearing roller
	81921718	DDP <sup>(3)</sup> 3/2 exhaust with barb connector	NC	Plastic idle-return roller
	81921719	DDP <sup>(3)</sup> 3/2 exhaust with barb connector	NC	Roller-bearing roller
	81921806	DDP <sup>(3)</sup> 3/2 exhaust with barb connector	NC	Plastic roller
	81921814	DDP <sup>(3)</sup> 3/2 exhaust with M5 connector	NC	Roller-bearing roller
	81921901	DDP <sup>(3)</sup> 3/2 exhaust with barb connector	NO	Plastic roller
	81921902	DDP <sup>(3)</sup> 3/2 exhaust with barb connector	NO	Roller-bearing roller
	81921911	DDP <sup>(3)</sup> 3/2 exhaust with barb connector	NO	Plastic roller
81921912	DDP <sup>(3)</sup> 3/2 exhaust with barb connector	NO	Roller-bearing roller	
<b>Compact</b>				
	81922010	DDP <sup>(3)</sup> 3/2	NC	Programmable rotary head, no lever
	81922205	DDP <sup>(3)</sup> 3/2	NC	Rotary head, action to right - roller-bearing roller lever
	81922210	DDP <sup>(3)</sup> 3/2	NC	Programmable rotary head, no lever
	81922211	DDP <sup>(3)</sup> 3/2	NC	Programmable rotary head, no lever
	81922401	DDP <sup>(3)</sup> 3/2 smooth barrel	NC	Roller plunger
	81922521	DDP <sup>(3)</sup> 3/2 smooth barrel	NC	Single plunger
<b>Accessories</b>				
	79452103	Roller lever		Plastic roller
	79452104	Roller lever		Roller-bearing roller
	79452123	Adjustable roller lever		Plastic roller
	79452124	Adjustable roller lever		Roller-bearing roller
	79452133	Rod lever		Adjustable rod
<b>Special</b>				
	81371401	Inductive proximity sensor Sensing distance 6 - 10 mm Ø M12 <sup>(1)</sup>		Change in air flow
	81372201	Movement sensor Sensing distance 0 - 18 mm, open-ended <sup>(1)</sup>		Break in air flow
	81372401	Movement sensor Sensing distance 0 - 100 mm - Ø M12 <sup>(1)</sup>		Break in air flow
	81372901	Sensor with palette <sup>(1)</sup> - 100 mm/200 mm		Palette
	81504025	Pressure decay sensor Tripping threshold at 6 bar: 0.3 bar		Pressure drop
	81512201	Ball-actuated detector, actuating force 0.8 N <sup>(2)</sup> , with leakage		Ball
	81512401	Wire-actuated leak sensor, actuating force 0.025 N <sup>(2)</sup> , with leakage		Wire
	81923001	Threaded barrel plunger detector Ø M12, actuating force < 16 N	NC	Single plunger

<sup>(1)</sup> For use with amplifiers **part no. 81510001** - <sup>(2)</sup> For use with relays for leak detectors **part no. 81502435** or **part no. 81505435** - <sup>(3)</sup> DDP: position detector







► Logic elements and automation controls

Product	Part number	Type	Function	Colour	Supply pressure
<b>Sequencer modules</b>					
	81550001	Sequencer module	Locking		2 - 8 bar
	81550201	Sequencer module	Reset		2 - 8 bar
	81550401	Sequencer module	Offset and locking		2 - 8 bar
	81550601	Sequencer module	Offset and reset		2 - 8 bar
<b>Logic elements</b>					
	81501025	YES element	With pressure indicators	Yellow	2 - 8 bar
	81501065	YES element	With pressure indicators and manual override	Yellow	2 - 8 bar
	81503025	YES element with threshold	With threshold and pressure indicators	Orange	2 - 8 bar
	81504025	NO element	With pressure indicators	Light grey	2 - 8 bar
	81506025	NO element with threshold	Inhibit with pressure indicators	Dark grey	2 - 8 bar
	81521501	OR element	With pressure indicators	Blue	2 - 8 bar
	81522501	AND element	With pressure indicators	Green	2 - 8 bar
	81540001	Plug-in OR element		Blue	2 - 8 bar
	81540005	Plug-in OR element		Blue	2 - 8 bar
	81541001	Plug-in AND element		Green	2 - 8 bar
81541005	Plug-in AND element		Green	2 - 8 bar	
<b>Memories</b>					
	81523201	Memory	Pressure indicator		2 - 8 bar
	81523601	Memory	Pressure indicator and manual override		2 - 8 bar
<b>Timers</b>					
	81503540	Fixed timer (0.4 s)	Positive output		2 - 8 bar
	81503710	Adjustable timer (0.1 to 15 s)	Positive output		2 - 8 bar
	81503716	Adjustable timer (0.1 to 5 s)	Positive output		2 - 8 bar
	81503720	Adjustable timer (0.1 to 30 s)	Positive output		2 - 8 bar
	81503725	Adjustable timer (0.1 to 60 s)	Positive output		2 - 8 bar
	81506540	Fixed timer (0.4 s)	Negative output		2 - 8 bar
	81506710	Adjustable timer (0.1 to 15 s)	Negative output		2 - 8 bar
	81506720	Adjustable timer (0.1 to 30 s)	Negative output		2 - 8 bar
	81506725	Adjustable timer (0.1 to 60 s)	Negative output		2 - 8 bar
	81506920	Adjustable frequency generator	0.04 - 12 Hz		2 - 8 bar
	81506940	Adjustable frequency generator	0.02 - 8 Hz		2 - 8 bar
	81506944	Adjustable frequency generator	0.02 - 3 Hz		2 - 8 bar
	81507540	Fixed-length single pulse generator (0.4 s)	Negative output		2 - 8 bar
	81507542	Fixed-length single pulse generator (0.8 s)	Negative output		2 - 8 bar
	81507720	Adjustable-length single pulse generator (1 to 30 s)	Negative output		2 - 8 bar
<b>Accessories</b>					
	79451698	Panel-mounted adaptor (part no. 81503710 and part no. 81506710)			
	79451903	Panel-mounted adaptor (part no. 81503720 and part no. 81506720)			
	79451904	Panel-mounted adaptor (part no. 81507720)			
	79451905	Panel-mounted adaptor (part no. 81506940)			

# Logic elements and automation controls

Flow rate	Connection	Operating temperature	Environment			
			Industrial	ATEX explosive atmosphere 		Approval
				ATEX part number	Certification type	
150 NI/min	On sub-base for register (pages 14 - 15)	-5°C → +50°C	✓	81550013	ExII2GDcIIB65°CT6	INERIS 18409/05
150 NI/min	On sub-base for register (pages 14 - 15)	-5°C → +50°C	✓	81550213	ExII2GDcIIB65°CT6	INERIS 18409/05
150 NI/min	On sub-base for register (pages 14 - 15)	-5°C → +50°C	✓	81550403	ExII2GDcIIB65°CT6	INERIS 18409/05
150 NI/min	On sub-base for register (pages 14 - 15)	-5°C → +50°C	✓	81550603	ExII2GDcIIB65°CT6	INERIS 18409/05
170 NI/min	On sub-base (pages 14 - 15)	-5°C → +50°C	✓	81501031	ExII2GDcIIB65°CT6	INERIS 18408/05
171 NI/min	On sub-base (pages 14 - 15)	-5°C → +50°C	✓	81501066	ExII2GDcIIB65°CT6	INERIS 18408/05
170 NI/min	On sub-base (pages 14 - 15)	-5°C → +50°C	✓	81503028	ExII2GDcIIB65°CT6	INERIS 18408/05
170 NI/min	On sub-base (pages 14 - 15)	-5°C → +50°C	✓	81504035	ExII2GDcIIB65°CT6	INERIS 18408/05
170 NI/min	On sub-base (pages 14 - 15)	-5°C → +50°C	✓	81506027	ExII2GDcIIB65°CT6	INERIS 18408/05
170 NI/min	On sub-base (pages 14 - 15)	-5°C → +50°C	✓	81521508	ExII2GDcIIB65°CT6	INERIS 18408/05
170 NI/min	On sub-base (pages 14 - 15)	-5°C → +50°C	✓	81522505	ExII2GDcIIB65°CT6	INERIS 18408/05
170 NI/min	Push-in for ext. tube Ø 4 mm	-5°C → +50°C	✓	81540015	ExII2GDcIIB65°CT6	INERIS 18408/05
200 NI/min	Push-in for ext. tube Ø 6 mm	-5°C → +50°C	✓	81540017	ExII2GDcIIB65°CT6	INERIS 18408/05
170 NI/min	Push-in for ext. tube Ø 4 mm	-5°C → +50°C	✓	81541015	ExII2GDcIIB65°CT6	INERIS 18408/05
200 NI/min	Push-in for ext. tube Ø 6 mm	-5°C → +50°C	✓	81541017	ExII2GDcIIB65°CT6	INERIS 18408/05
200 NI/min	On sub-base (pages 14 - 15)	-5°C → +50°C	✓	81523205	ExII2GDcIIB55°CT6	INERIS 17564/04
200 NI/min	On sub-base (pages 14 - 15)	-5°C → +50°C	✓	81523608	ExII2GDcIIB55°CT6	INERIS 17564/04
170 NI/min	On sub-base (pages 14 - 15)	-5°C → +50°C	✓	81503543	ExII2GDcIIB60°CT6	INERIS 18410/05
170 NI/min	On sub-base (pages 14 - 15)	-5°C → +50°C	✓	81503728	ExII2GDcIIB60°CT6	INERIS 18410/05
170 NI/min	On sub-base (pages 14 - 15)	-5°C → +50°C	✓			
170 NI/min	On sub-base (pages 14 - 15)	-5°C → +50°C	✓	81503729	ExII2GDcIIB60°CT6	INERIS 18410/05
170 NI/min	On sub-base (pages 14 - 15)	-5°C → +50°C	✓	81503731	ExII2GDcIIB60°CT6	INERIS 18410/05
170 NI/min	On sub-base (pages 14 - 15)	-5°C → +50°C	✓	81506541	ExII2GDcIIB60°CT6	INERIS 18410/05
170 NI/min	On sub-base (pages 14 - 15)	-5°C → +50°C	✓	81506714	ExII2GDcIIB60°CT6	INERIS 18410/05
170 NI/min	On sub-base (pages 14 - 15)	-5°C → +50°C	✓	81506721	ExII2GDcIIB60°CT6	INERIS 18410/05
170 NI/min	On sub-base (pages 14 - 15)	-5°C → +50°C	✓	81506727	ExII2GDcIIB60°CT6	INERIS 18410/05
170 NI/min	On sub-base (pages 14 - 15)	-5°C → +50°C	✓			
170 NI/min	On sub-base (pages 14 - 15)	-5°C → +50°C	✓	81506945	ExII2GDcIIB60°CT6	INERIS 18410/05
170 NI/min	On sub-base (pages 14 - 15)	-5°C → +50°C	✓			
170 NI/min	On sub-base (pages 14 - 15)	-5°C → +50°C	✓	81507543	ExII2GDcIIB60°CT6	INERIS 18410/05
170 NI/min	On sub-base (pages 14 - 15)	-5°C → +50°C	✓			
170 NI/min	On sub-base (pages 14 - 15)	-5°C → +50°C	✓	81507724	ExII2GDcIIB60°CT6	INERIS 18410/05
			✓	79451698	Accessories are ATEX approved if used with an approved relay	INERIS 18410/05
			✓	79451903		INERIS 18410/05
			✓	79451904		INERIS 18410/05
			✓	79451905		INERIS 18410/05

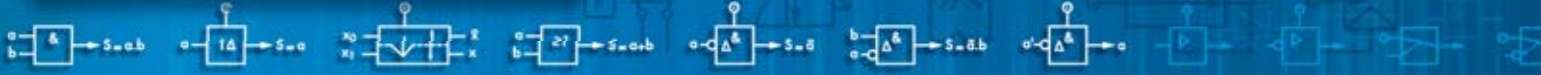

▶ Logic elements and automation controls

Product	Part number	Type	Function	Characteristics	Colour	Supply pressure
---------	-------------	------	----------	-----------------	--------	-----------------

Flow restrictors, capacities, non-return



	79452808	Capacity 30 cm <sup>3</sup>				
	81520601	Plug element	Sub-base plug			
	81525101	Adjustable flow restrictor	One-way adjustable flow restrictor	Orifice diameter 0 to 0.5 mm		1 - 8 bar
	81526001	Adjustable flow restrictor	One-way adjustable flow restrictor	Orifice diameter 0 to 1.7 mm		2 - 8 bar
	81527001	Mini-regulator	Regulator	Output pressure 0.1 to 8 bar		2 - 8 bar
	81529003	Fixed flow restrictor	One-way in-line	Orifice diameter 0.3 mm	White	1 - 8 bar
	81529004	Fixed flow restrictor	One-way in-line	Orifice diameter 0.4 mm	Yellow	1 - 8 bar
	81529005	Fixed flow restrictor	One-way in-line	Orifice diameter 0.5 mm	Red	1 - 8 bar
	81529006	Fixed flow restrictor	One-way in-line	Orifice diameter 0.6 mm	Green	1 - 8 bar
	81529007	Fixed flow restrictor	One-way in-line	Orifice diameter 0.7 mm	Blue	1 - 8 bar
	81529008	Fixed flow restrictor	One-way in-line	Orifice diameter 0.8 mm	Grey	1 - 8 bar
	81529010	Fixed flow restrictor	One-way in-line	Orifice diameter 1 mm	Black	1 - 8 bar
	81529025	Fixed flow restrictor	One-way in-line	Orifice diameter 0.25 mm		1 - 8 bar
	81529901	Non-return	In-line			2 - 8 bar

Component modularity

Memory (page 12) | Other

Sub-base

For registers



	81551001	Sub-base for register	Rear wiring	Clips		
	81551101	Sub-base for register	Front wiring, adjustable connections and pressure indicator	DIN rail mounting (Omega)		
	81552001	End bases for register	Rear wiring and pressure indicator	Clips		
	81552101	End bases for register	Front wiring, adjustable connections and pressure indicator	DIN rail mounting (Omega)		
	81552601	Diversion base for register	Front wiring, adjustable connections and pressure indicator	DIN rail mounting (Omega)		

For logic elements, timers, memories and valve modules



	81531001	Sub-base for logic elements and relays	Rear wiring	Clips	1	2
	81532001	Sub-base for logic elements	Rear wiring	Frame mounting	-	1
	81532102	Sub-base for logic elements	Front wiring, adjustable connectors	DIN rail mounting (Omega)	-	1
	81532104	Sub-base for logic elements	Front wiring, adjustable connectors	DIN rail mounting (Omega)	-	1
	81542002	Sub-base for memories	Front wiring, adjustable connectors	DIN rail mounting (Omega)	1	-

Fixing positions

	79450609	Clips	Bar mounted Ø 8 mm			
	79450618	Locking clip				
	81533001	Clip domino	Adjustable DIN rail fixing (asymmetrical) on 8 mm Ø rod			
	81533501	Hole domino	DIN rail fixing (asymmetrical) on end of 8 mm Ø rod			
	81536801	Supply base 13 outputs				



# Logic elements and automation controls

	Flow rate	Connection	Operating temperature	Environment			
				Industrial	ATEX explosive atmosphere 		Approval
					ATEX part number	Certification type	
		Push-in for ext. tube Ø 4 mm	-5°C → +50°C	✓	79458018	ExII2GDcIIB90°CT5	INERIS 18410/05
		On sub-base (pages 14 - 15)	-5°C → +50°C	✓	81520 602	ExII2GDcIIBT6	INERIS 18410/05
	open 30 NI/min	On sub-base (pages 14 - 15)	-5°C → +50°C	✓	81525106	ExII2GDcIIB60°CT6	INERIS 18410/05
	open 200 NI/min	On sub-base (pages 14 - 15)	-5°C → +50°C	✓	81526006	ExII2GDcIIB60°CT6	INERIS 18410/05
	200 NI/h at 6 bars	On sub-base (pages 14 - 15)	-5°C → +50°C	✓			
	180 at 300 NI/h at 4 bars	Push-in for ext. tube Ø 4 mm	-5°C → +50°C	✓	81529013	ExII2GDcIIB60°CT6	INERIS 18410/05
	350 at 500 NI/h at 4 bars		-5°C → +50°C	✓	81529014	ExII2GDcIIB60°CT6	INERIS 18410/05
	580 at 770 NI/h at 4 bars		-5°C → +50°C	✓	81529015	ExII2GDcIIB60°CT6	INERIS 18410/05
	800 at 1060 NI/h at 4 bars		-5°C → +50°C	✓	81529016	ExII2GDcIIB60°CT6	INERIS 18410/05
	1100 at 1390 NI/h at 4 bars		-5°C → +50°C	✓	81529017	ExII2GDcIIB60°CT6	INERIS 18410/05
	1450 at 1650 NI/h at 4 bars		-5°C → +50°C	✓	81529018	ExII2GDcIIB60°CT6	INERIS 18410/05
	2300 at 2800 NI/h at 4 bars		-5°C → +50°C	✓	81529020	ExII2GDcIIB60°CT6	INERIS 18410/05
	80 at 120 NI/h at 4 bars		-5°C → +50°C	✓	81529026	ExII2GDcIIB60°CT6	INERIS 18410/05
	200 NI/h at 6 bars		-5°C → +50°C	✓	81529907	ExII2GDcIIB60°CT6	INERIS 18410/05
			Push-in for ext. tube Ø 4 mm	-5°C → +50°C	✓	81551004	ExII2GDcIIBT6
		-5°C → +50°C		✓	81551104	ExII2GDcIIBT6	INERIS 18409/05
		-5°C → +50°C		✓	81552005	ExII2GDcIIBT6	INERIS 18409/05
		-5°C → +50°C		✓	81552105	ExII2GDcIIBT6	INERIS 18409/05
		-5°C → +50°C		✓	81552605	ExII2GDcIIBT6	INERIS 18409/05
		Push-in for ext. tube Ø 4 mm		-5°C → +50°C	✓	81531008	ExII2GDcIIBT6
			-5°C → +50°C	✓	81532009	ExII2GDcIIBT6	INERIS 18408/05
			-5°C → +50°C	✓	81532109	ExII2GDcIIBT6	INERIS 18408/05
			-5°C → +50°C	✓	81532111	ExII2GDcIIBT6	INERIS 18408/05
			-5°C → +50°C	✓	81542004	ExII2GDcIIBT6	INERIS 17564/04
			-5°C → +50°C	✓	79450609	Accessories approved if used with an approved product	INERIS 18408/05
			-5°C → +50°C	✓	79450618		INERIS 18408/05
			-5°C → +50°C	✓	81533001	Accessories approved if used with an approved product	INERIS 18408/05
			-5°C → +50°C	✓	81533501		INERIS 18408/05
			-5°C → +50°C	✓	81536804	ExII2GDcIIBT6	INERIS 18408/05



► Automation controls

Product	Part number	Type	Mounting	Version	Control	Pressure to make	Contact rating
<b>Pressure switches</b>							
	81509080	Pressure switch		No manual override	Pressure	1.4 ± 0.5 bar	5 A - 220 V ~
	81509085	Pressure switch		With manual override	Pressure	1.4 ± 0.5 bar	5 A - 220 V ~
	81513501	Pressure switch with pressure indicator	On DIN rail (Omega)	No manual override	Low pressure	0.3 - 1.2 bar	5 A - 220 V ~
	81513502	Pressure switch with pressure indicator	On DIN rail (Omega)	No manual override	Pressure	2 - 8 bar	5 A - 220 V ~
	81513509	Low-hysteresis pressure switch with pressure indicator	On DIN rail (Omega)	No manual override	Pressure	3 - 8 bar	5 A - 220 V ~
	81513510	Pressure switch		With manual override	Pressure	2 - 8 bar	5 A - 220 V ~
	81513516	Pressure switch		No manual override	Pressure	2 - 8 bar	5 A - 220 V ~
	81513518	Pressure switch with Viton® membrane	On frame	No manual override	Low pressure	-0.3 - 1.2 bar	5 A - 220 V ~
	81513533	Pressure switch	On frame	No manual override	Pressure	2 - 8 bar	5 A - 220 V ~
	81513535	Pressure switch with Viton® membrane and pressure indicator	On frame	No manual override	Pressure	3 - 8 bar	5 A - 220 V ~
	81513552	Pressure switch with pressure indicator	On DIN rail (Omega)	With manual override	Pressure	2 - 8 bar	5 A - 220 V ~
	81513561	Pressure switch	On DIN rail (Omega)	With manual override	Pressure	3 - 8 bar	5 A - 220 V ~
	81513570	Pressure switch	On frame	No manual override	Pressure	0.5 - 3 bar	5 A - 220 V ~
	81513574	Pressure switch with pressure indicator	On DIN rail (Omega)	No manual override	Pressure	2 - 8 bar	5 A - 220 V ~
					<b>Hysteresis</b>	<b>Adjustment range</b>	<b>Repeat accuracy</b>
<b>Pressure switches</b>							
	81502140	Pressure switch		Negative output	60 mbar	50 - 500 mbar	10 %
	81502150	Pressure switch		Negative output	100 mbar	0.1 - 2.5 bar	4 %
	81502160	Pressure switch		Negative output	320 mbar	2 - 8 bar	4 %
	81505140	Pressure switch		Positive output	60 mbar	50 - 500 mbar	10 %
	81505150	Pressure switch		Positive output	100 mbar	0.1 - 2.5 bar	4 %
	81505160	Pressure switch		Positive output	320 mbar	2 - 8 bar	4 %
	81505161	Pressure switch, leaf-proof		Positive output	320 mbar	2 - 8 bar	4 %
	81508150	Pressure switch with electrical output			100 mbar	2 - 8 bar	
	81508160	Pressure switch with electrical output			250 mbar	0.1 - 2.5 bar	
<b>Vacuum switches</b>							
	81502110	Vacuum switch		Negative output	80 mbar	-0.1 - 0.9 bar	
	81505110	Vacuum switch		Positive output	80 mbar	-0.1 - 0.9 bar	
	81508110	Vacuum switch with electrical output		Electrical output	80 mbar	-0.1 - 0.9 bar	
	81513522	Vacuum switch	On DIN rail (Omega)	No manual override	Empty	-0.3 - 0.8 bar	5 A - 220 V ~
	81513523	Vacuum switch	On frame	No manual override	Empty	-0.3 - 0.8 bar	5 A - 220 V ~
	81513525	Vacuum switch with Viton® membrane	On frame	No manual override	Empty	-0.3 - 0.8 bar	5 A - 220 V ~
	81513527	Vacuum switch		No manual override	Empty	-0.3 - 0.8 bar	5 A - 220 V ~



# Logic elements and automation controls

	Connection	Operating temperature	Approval	Environment			
				Industrial	ATEX explosive atmosphere 	ATEX part number	Certification type
	On sub-base (pages 14 - 15)	-10°C → +70°C		✓			
	On sub-base (pages 14 - 15)	-10°C → +70°C		✓			
	Push-in for ext. tube Ø 4 mm	-10°C → +70°C	MH15213R	✓			
	Push-in for ext. tube Ø 4 mm	-10°C → +70°C	MH15213R	✓			
	Push-in for ext. tube Ø 4 mm	-10°C → +70°C	MH15213R	✓			
	On sub-base (pages 14 - 15)	-10°C → +70°C	MH15213R	✓			
	On sub-base (pages 14 - 15)	-10°C → +70°C	MH15213R	✓			
	Gas 1/8	-10°C → +70°C	MH15213R	✓			
	Gas 1/8	-10°C → +70°C	MH15213R	✓			
	Gas 1/8	-10°C → +70°C	MH15213R	✓			
	Push-in for ext. tube Ø 4 mm	-10°C → +70°C	MH15213R	✓	81513530	ExII1GExiallCT6	LCIE 02ATEX6121X
	Push-in for ext. tube Ø 4 mm	-10°C → +70°C	MH15213R	✓			
	Gas 1/8	-10°C → +70°C	MH15213R	✓			
	Push-in for ext. tube Ø 4 mm	-10°C → +70°C	MH15213R	✓			
			<b>Flow rate at 4 bars</b>				
	On sub-base (pages 14 - 15)	-5°C → +50°C	170 NI/min	✓	81502141	ExII2GDclIB60°CT6	INERIS 18410/05
	On sub-base (pages 14 - 15)	-5°C → +50°C	170 NI/min	✓	81502151	ExII2GDclIB60°CT6	INERIS 18410/05
	On sub-base (pages 14 - 15)	-5°C → +50°C	170 NI/min	✓	81502162	ExII2GDclIB60°CT6	INERIS 18410/05
	On sub-base (pages 14 - 15)	-5°C → +50°C	170 NI/min	✓	81505141	ExII2GDclIB60°CT6	INERIS 18410/05
	On sub-base (pages 14 - 15)	-5°C → +50°C	170 NI/min	✓	81505151	ExII2GDclIB60°CT6	INERIS 18410/05
	On sub-base (pages 14 - 15)	-5°C → +50°C	170 NI/min	✓	81505164	ExII2GDclIB60°CT6	INERIS 18410/05
	On sub-base (pages 14 - 15)	-5°C → +50°C	170 NI/min	✓			
	On sub-base (pages 14 - 15)	-5°C → +50°C		✓			
	On sub-base (pages 14 - 15)	-5°C → +50°C		✓			
	On sub-base (pages 14 - 15)	-5°C → +50°C	170 NI/min	✓	81502111	ExII2GDclIB60°CT6	INERIS 18410/05
	On sub-base (pages 14 - 15)	-5°C → +50°C	170 NI/min	✓	81505111	ExII2GDclIB60°CT6	INERIS 18410/05
	On sub-base (pages 14 - 15)	-5°C → +50°C	170 NI/min	✓			
	Push-in for ext. tube Ø 4 mm	-10°C → +70°C		✓			
	Gas 1/8	-10°C → +70°C		✓			
	Gas 1/8	-10°C → +70°C		✓			
	On sub-base (pages 14 - 15)	-10°C → +70°C		✓			

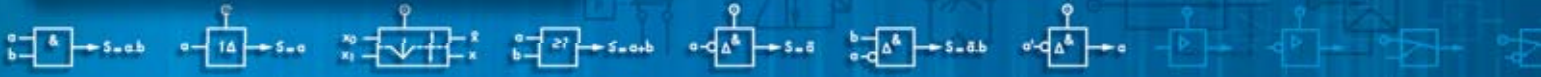



► Automation controls

Product	Part number	Name	Mounting	Version	Average consumption	Pressure to make
<b>Relays</b>						
<b>For leak detectors</b>						
	81502435	Relay for leak detector		Positive output	5 NI/min - 6 bar	
	81505435			Negative output	5 NI/min - 6 bar	
<b>Amplifier relays</b>						
	81502230	Single amplifier		Positive output	5 NI/min - 4 bar	10 - 20 mbar
	81502320	Pressure-sensitive amplifier		Positive output	5 NI/min - 4 bar	1 - 4 mbar
	81505230	Single amplifier		Negative output	5 NI/min - 4 bar	10 - 20 mbar
	81505320	Pressure-sensitive amplifier		Negative output	5 NI/min - 4 bar	1 - 4 mbar
	81510001	Amplifier relay	On frame	Positive output		0.5 - 1.5 mbar
<b>Indicators</b>						
	84150201	Pneumatic indicator	Ø 22 mm	Red		
	84150202	Pneumatic indicator	Ø 22 mm	Green		
	84150203	Pneumatic indicator	Ø 22 mm	Yellow		
	84150204	Pneumatic indicator	Ø 22 mm	Blue		
<b>Counters</b>						
	99766001	Flush-mounting counter	Base-mounted	6 digits, no reset		
	99766002	Flush-mounting counter	Base-mounted	4 digits, with reset		
	89538201	Preselection counter	Base-mounted	5 digits manual/pneumatic reset		
<b>Controls</b>						
<b>Two-hand controls</b>						
	81580503	Two-hand control module	4 x 4.2 mm screws	Type III A - EN 574		EN574
	81580504			Type III B - EN 574		EN574
<b>Foot switches</b>						
	81999501	Pneumatic foot switch NC				
<b>Pneumatic relays</b>						
	81580101	Pneumatic relay for two-hand control	Sub-base	Type III A - EN 574		CE test type 0526 520 1690 0197
	81580202		Sub-base	Type III B - EN 574		CE test type 0526 520 1690 0197
<b>Vacuum generators</b>						
	81535 301	Vacuum generator	Sub-base			
	81545 001	Vacuum generator	Plug-in	Male-Female-Female		
	81545 005	Vacuum generator	Plug-in	Female-Female-Female		

# Logic elements and automation controls

	Connection	Supply pressure	Operating temperature	Environment				
				Industrial	ATEX explosive atmosphere 	ATEX part number	Certification type	Approval
	On sub-base (pages 14 - 15)	2 - 8 bar	-5°C → +50°C	✓	81502438	ExII2GDcIIB60°CT6	INERIS 18410/05	
		2 - 8 bar	-5°C → +50°C	✓	81505437	ExII2GDcIIB60°CT6	INERIS 18410/05	
	On sub-base (pages 14 - 15)	2 - 8 bar	-5°C → +50°C	✓	81502238	ExII2GDcIIB60°CT6	INERIS 18410/05	
		2 - 6 bar	-5°C → +50°C	✓	81502322	ExII2GDcIIB60°CT6	INERIS 18410/05	
		2 - 8 bar	-5°C → +50°C	✓	81505231	ExII2GDcIIB60°CT6	INERIS 18410/05	
		2 - 6 bar	-5°C → +50°C	✓	81505321	ExII2GDcIIB60°CT6	INERIS 18410/05	
	Push-in for ext. tube Ø 4 mm		-5°C → +50°C	✓				
	Push-in for ext. tube Ø 4 mm	2 - 8 bar	-5°C → +50°C	✓	84150214	ExII2GDcIIB65°CT6	INERIS 18398/05	
		2 - 8 bar	-5°C → +50°C	✓	84150215	ExII2GDcIIB65°CT6	INERIS 18398/05	
		2 - 8 bar	-5°C → +50°C	✓	84150216	ExII2GDcIIB65°CT6	INERIS 18398/05	
		2 - 8 bar	-5°C → +50°C	✓	84150217	ExII2GDcIIB65°CT6	INERIS 18398/05	
	Push-in for ext. tube Ø 4 mm	2 - 8 bar	0 → +60°C	✓				
		2 - 8 bar	0 → +60°C	✓				
		2 - 8 bar	0 → +60°C	✓				
	Push-in for ext. tube Ø 4 mm	2 - 8 bar	-5°C → +50°C	✓				
		2 - 8 bar	-5°C → +50°C	✓				
	Push-in for ext. tube Ø 4 mm	2 - 8 bar	-5°C → +50°C	✓				
	On sub-base (pages 14 - 15)	2 - 8 bar	-5°C → +50°C	✓				
	Push-in for ext. tube Ø 4 mm	2 - 8 bar	-5°C → +50°C	✓				
	On sub-base (pages 14 - 15)	2 - 8 bar	-5°C → +50°C	✓	81535303	ExII2GDcIIB65°CT6	INERIS 18408/05	
		Push-in for ext. tube Ø 4 mm	2 - 8 bar	-5°C → +50°C	✓	81545012	ExII2GDcIIB65°CT6	INERIS 18408/05
		Push-in for ext. tube Ø 6 mm	2 - 8 bar	-5°C → +50°C	✓	81545013	ExII2GDcIIB65°CT6	INERIS 18408/05



► Miniature solenoid valves for valve modules

**General characteristics**

- Supply pressure: 1 - 8 bar
- Response time: 5 - 15 ms
- Operating temperature: -10°C → +50°C
- Electrical connection: flat faston connectors 2.8 x 0.5; with 4 possible positions
- MH 15085 approval
- Duty factor 100%

Product	Part number	Type	Characteristics
---------	-------------	------	-----------------

**Miniature solenoid valves for valve modules**

**Direct current**



81519031	Miniature solenoid valves 3/2 NC - Ø 0.8 - 1 watt	No manual override
81519032	Miniature solenoid valves 3/2 NC - Ø 0.8 - 1 watt	No manual override
81519052	Miniature solenoid valves 3/2 NC - lead output - Ø 0.8 - 1 watt	No manual override
81519060	Miniature solenoid valves 3/2 NC - Ø 1.5 - 2.8 watt	No manual override
81519132	Miniature solenoid valves 3/2 NO - Ø 0.8 - 1 watt	No manual override
81519331	Miniature solenoid valves 3/2 NC - Ø 0.8 - 1 watt	With manual override by impulse
81519332	Miniature solenoid valves 3/2 NC - Ø 0.8 - 1 watt	With manual override by impulse
81519333	Miniature solenoid valves 3/2 NC - Ø 0.8 - 1 watt	With manual override by impulse
81519631	Miniature solenoid valves 3/2 NC - Ø 0.8 - 1 watt	With manual override by 1/4 turn latching
81519632	Miniature solenoid valves 3/2 NC - Ø 0.8 - 1 watt	With manual override by 1/4 turn latching

**Alternating current**

81519080	Miniature solenoid valves 3/2 NC - Ø 0.5	No manual override
81519378	Miniature solenoid valves 3/2 NC - Ø 0.5	With manual override by impulse
81519379	Miniature solenoid valves 3/2 NC - Ø 0.5	With manual override by impulse
81519380	Miniature solenoid valves 3/2 NC - Ø 0.5	With manual override by impulse
81519381	Miniature solenoid valves 3/2 NC - Ø 0.5	With manual override by impulse
81519678	Miniature solenoid valves 3/2 NC - Ø 0.5	With manual override by 1/4 turn latching
81519679	Miniature solenoid valves 3/2 NC - Ø 0.5	With manual override by 1/4 turn latching
81519680	Miniature solenoid valves 3/2 NC - Ø 0.5	With manual override by 1/4 turn latching
81519681	Miniature solenoid valves 3/2 NC - Ø 0.5	With manual override by 1/4 turn latching

**Miniature solenoid valves for valve modules, fitted with connector**

	Miniature solenoid valves 3/2 NC - Ø 0.8 - 1 watt	No manual override
	Miniature solenoid valves 3/2 NC - Ø 0.8 - 1 watt	With manual override by impulse
	Miniature solenoid valves 3/2 NC - Ø 0.8 - 1 watt	With manual override by 1/4 turn latching
	Miniature solenoid valves 3/2 NC - Ø 0.8 - 1 watt	No manual override
	Miniature solenoid valves 3/2 NC - Ø 0.8 - 1 watt	With manual override by impulse
	Miniature solenoid valves 3/2 NC - Ø 0.8 - 1 watt	With manual override by 1/4 turn latching

**Accessories**



81513052	LED	Interference suppression and readout
81513055	LED	Interference suppression and readout
81513058	LED	Interference suppression and readout
81513059	LED	Interference suppression and readout
81513064	Indicator seal	
81537001	Plug-in silencer	Plug-in Ø 6 mm
81537201	Plug-in silencer	Plug-in Ø 8 mm
81516081	Pneumatic pilot	No manual override/push-in for ext. tube Ø 4 mm
81516082	Connector	
81516085	Blanking plate	

**Sub-bases**



81514101	End base for miniature solenoid valve	Pneumatic indicator
81514161	Intermediate base for miniature solenoid valve	Pneumatic indicator
79453569	CNOMO sub-base for miniature solenoid valve	CNOMO NFE 49 066 footprint
79452445	Blanking plate	

# Directional control

	Supply voltage	Flow rate	Environment			
			Industrial	ATEX explosive atmosphere 		Approval
				ATEX part number	Certification type	
	12 V ~	25 NI/min		81519034	ExII1GExialICT6	LCIE 02ATEX6121X
	24 V ~	25 NI/min	✓	81519035	ExII1GExialICT6	LCIE 02ATEX6121X
	24 V ~	25 NI/min	✓			
	24 V ~		✓			
	24 V ~	25 NI/min	✓			
	12 V ~	25 NI/min		81519334	ExII1GExialICT6	LCIE 02ATEX6121X
	24 V ~	25 NI/min	✓	81519335	ExII1GExialICT6	LCIE 02ATEX6121X
	48 V ~	25 NI/min	✓			
	12 V ~	25 NI/min		81519634	ExII1GExialICT6	LCIE 02ATEX6121X
	24 V ~	25 NI/min	✓	81519635	ExII1GExialICT6	LCIE 02ATEX6121X
	24 V ~ - 50 - 60 Hz	12 NI/min	✓			
	110 V ~ - 50 - 60 Hz	12 NI/min	✓			
	220 V ~ - 50 - 60 Hz	12 NI/min	✓			
	24 V ~ - 50 - 60 Hz	12 NI/min	✓			
	48 V ~ - 50 - 60 Hz	12 NI/min	✓			
	110 V ~ - 50 - 60 Hz	12 NI/min	✓			
	220 V ~ - 50 - 60 Hz	12 NI/min	✓			
	24 V ~ - 50 - 60 Hz	12 NI/min	✓			
	48 V ~ - 50 - 60 Hz	12 NI/min	✓			
	12 V ~	25 NI/min		81519047	(1)	LCIE 02ATEX6121X
	12 V ~	25 NI/min		81519347	(1)	LCIE 02ATEX6121X
	12 V ~	25 NI/min		81519647	(1)	LCIE 02ATEX6121X
	24 V ~	25 NI/min		81519048	(1)	LCIE 02ATEX6121X
	24 V ~	25 NI/min		81519348	(1)	LCIE 02ATEX6121X
	24 V ~	25 NI/min		81519648	(1)	LCIE 02ATEX6121X
	<b>Connection</b>					
	24 V ~ - 50 - 60 Hz		✓	81513052	Accessory (2)	LCIE 02ATEX6121X
	48 V ~ - 50 - 60 Hz		✓			
	110 V ~ - 50 - 60 Hz		✓			
	220 V ~ - 50 - 60 Hz		✓			
	12-24 V ~ - 50 - 60 Hz		✓			
			✓			
			✓	81516093	ExII2GDclIBT6	INERIS 17564/04
			✓	81516085	Accessory (2)	INERIS 17564/04
	<b>Fixing</b>					
	DIN rail mounting (Omega)	Push-in for ext. tube Ø 4 mm	✓			
	DIN rail mounting (Omega)	Push-in for ext. tube Ø 4 mm	✓			
	2 x M4x10 screws		✓	79453569	Accessory (2)	INERIS 17564/04
			✓			

(1) Reference: ExII1GExialICT6ExiaD20T80°C.

(2) Accessory is ATEX approved if used with an ATEX product.





► Stand-alone miniature solenoid valves

**General characteristics**

- Supply pressure: 1 - 8 bar
- Voltage: 24 V  $\overline{\text{---}}$
- Operating temperature: -10°C  $\rightarrow$  +50°C
- Response time: 5 - 15 ms
- Electrical connection: flat faston connectors 2.8 x 0.5; with 4 possible positions
- MH 15085 approval
- No manual override - no pressure indicator

Product	Part number	Type	Operation
<b>Stand-alone miniature solenoid valves</b>			
<b>Direct current</b>			
	81546001	Miniature solenoid valves 2/2 NC - Ø 0.8 - 1 watt - 24 V $\overline{\text{---}}$	Individual
	81547001	Set of 2 miniature solenoid valves 2/2 NC - Ø 0.8 - 1 watt - 24 V $\overline{\text{---}}$	In bank - end position
	81547501	Miniature solenoid valves 2/2 NC - Ø 0.8 - 1 watt - 24 V $\overline{\text{---}}$	In bank - intermediate position
	81548010	Miniature solenoid valves 3/2 NC - Ø 0.8 - 1 watt - 24 V $\overline{\text{---}}$	Individual
	81549002	Set of 2 miniature solenoid valves 3/2 NC - Ø 0.8 - 1 watt - 24 V $\overline{\text{---}}$	In bank - end position
	81549010	Set of 2 miniature solenoid valves 3/2 NC - Ø 0.8 - 1 watt - 24 V $\overline{\text{---}}$	In bank - end position
	81549502	Miniature solenoid valves 3/2 NC - Ø 0.8 - 1 watt - 24 V $\overline{\text{---}}$	In bank - intermediate position
81549510	Miniature solenoid valves 3/2 NC - Ø 0.8 - 1 watt - 24 V $\overline{\text{---}}$	In bank - intermediate position	

► Medical bed application

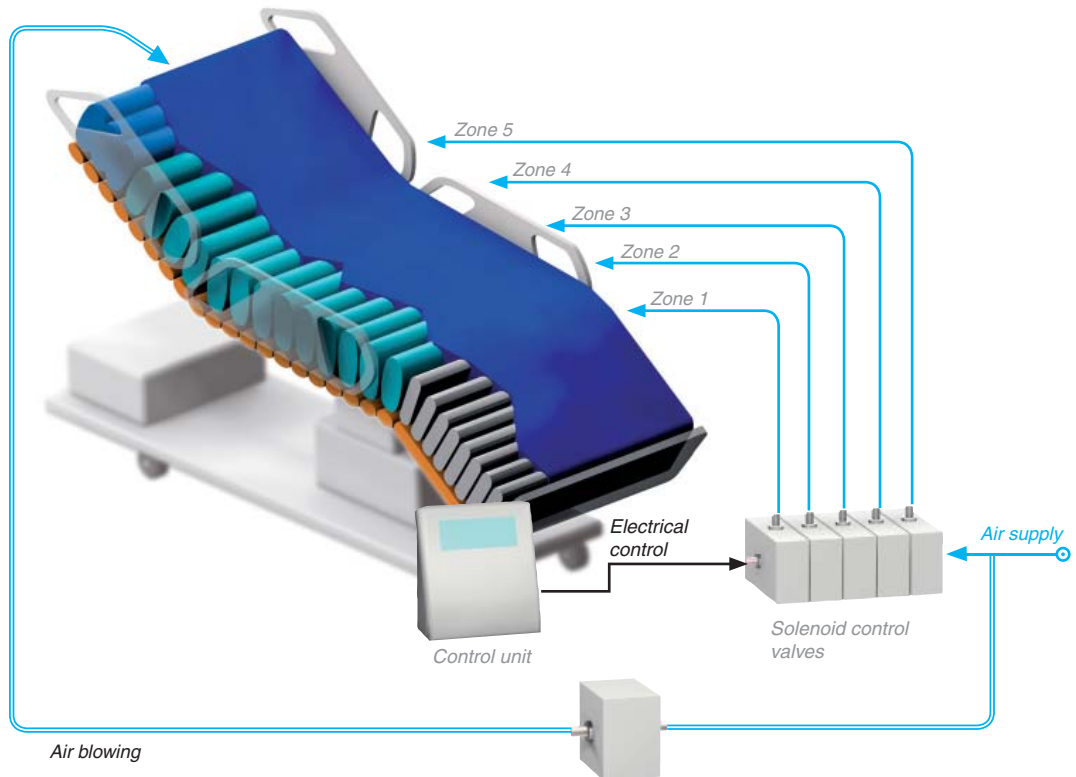

■ **Description**

Pressure-relief mattresses for medical applications make use of an automatic pressure control system to ensure maximum comfort for each patient.

Pneumatic valves are used to distribute the patient's weight in the best possible way; by alternating pressures it is possible to reduce the apparent weight on the mattress for the relief of pressure sores.

# Directional control

Version	Connection	Environment				
		Industrial	ATEX explosive atmosphere 	ATEX part number	Certification type	Approval
NC	M5	✓				
NC	M5	✓				
NC	M5	✓				
NC	M5	✓				
NC	Barbs for int. tube Ø 2.7 mm	✓				
NC	M5	✓				
NC	Barbs for int. tube Ø 2.7 mm	✓				
NC	M5	✓				

## ► Textile machine application

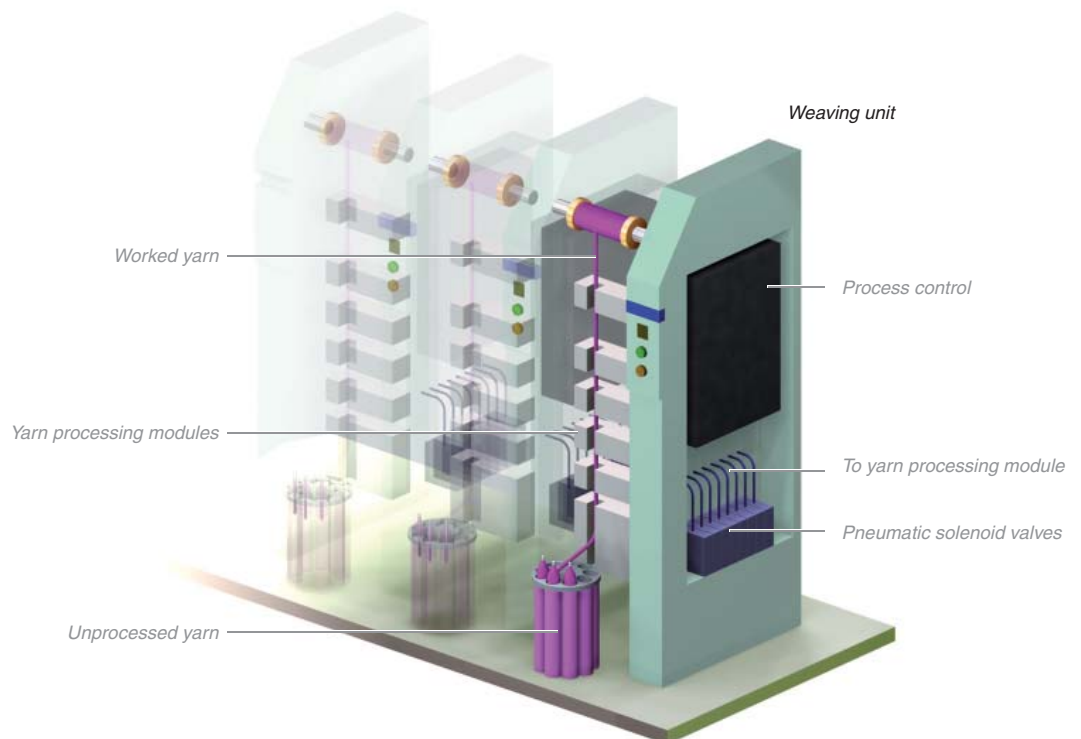

### ■ Description

Compressed air is used in the textile industry to control the principal functions in yarn processing (drawing, twisting, threading, attachment and lifting, etc.), minimising the contact points to improve the reliability of the process.

The winding units are arranged as independent modules in which pneumatic control is provided by a set (station) of interconnected pneumatic solenoid valves.



▶ Valve modules

Product	Part number	Type	Flow rate	Function	Connection	Voltage
<b>Valve modules</b>						
<b>3/2</b>						
	81513100	Poppet valve module 17.5 mm	200/300 NI/min	3/2 NC	On sub-base (below)	
	81513600	Poppet valve module 17.5 mm	200/300 NI/min	3/2 NO	On sub-base (below)	
	81519732	Poppet valve module 17.5 mm	170 NI/min	3/2 NC	On sub-base for logic elements (pages 14 - 15)	24 V $\overline{\text{DC}}$
	81519774		170 NI/min	3/2 NC		24 V $\sim$ - 50 - 60 Hz
	81519776		170 NI/min	3/2 NC		110 V $\sim$ - 50 - 60 Hz
	81519777		170 NI/min	3/2 NC		230 V $\sim$ - 50 - 60 Hz
	81519832		171 NI/min	3/2 NO		24 V $\overline{\text{DC}}$
<b>4/2 - 5/2 - 5/3</b>						
	81513200	Poppet valve module 17.5 mm	200/300 NI/min	4/2 monostable	On sub-base (below)	
	81516100	Valve module 35 mm	300/400 NI/min	4/2 pressure/spring	On sub-base (below)	
	81516200	Valve module 35 mm	300/400 NI/min	4/2 pressure/pressure	On sub-base (below)	
	89541007	Valve module <b>(ISO size 1)</b>	1400 NI/min	5/2 pressure/spring	On sub-base (below)	
	89541037	Valve module <b>(ISO size 1)</b>	1400 NI/min	5/2 pressure/pressure	On sub-base (below)	
	89541047	Valve module <b>(ISO size 1)</b>	1400 NI/min	5/3 pressure/pressure closed centre	On sub-base (below)	
	89541067	Valve module <b>(ISO size 1)</b>	1400 NI/min	5/3 pressure/pressure centre open for exhaust	On sub-base (below)	
						<b>Fixing</b>
<b>Sub-bases/Accessories</b>						
	81513001	Supply module			Push-in for ext. tube $\varnothing$ 6 mm	DIN rail mounting (Omega)
	81513011	End base			Push-in for ext. tube $\varnothing$ 6 mm	
	81513012	End base			Gas 1/8	
	81513060	Sub-base 17.5 mm			Push-in for ext. tube $\varnothing$ 4 mm	
	81513065	Sub-base 17.5 mm			Push-in for ext. tube $\varnothing$ 6 mm	
81516085	Blanking plate			Plug		
	81517101	Sub-base 35 mm <sup>(1)</sup>			Push-in for ext. tube $\varnothing$ 4 mm	DIN rail mounting (Omega)
	81517201	Sub-base 35 mm <sup>(1)</sup>			Push-in for ext. tube $\varnothing$ 6 mm	DIN rail mounting (Omega)
	81543006	Sub-base <b>(ISO size 1)</b>			Push-in for ext. tube $\varnothing$ 6 mm	Clips for rod $\varnothing$ 8
	81543206	Sub-base <b>(ISO size 1)</b>			Push-in for ext. tube $\varnothing$ 8 mm	Clips for rod $\varnothing$ 8

<sup>(1)</sup> Sub-base can take 2 valve modules of length 17.5 mm.

# Directional control

	Supply pressure	Operating temperature	Approval	Environment			
				Industrial	ATEX explosive atmosphere 	ATEX part no.	Certification type
	3 - 8 bar	-10°C → +50°C		✓	81513196	ExII2GDcIIIB55°CT6	INERIS 17567/04
	3 - 8 bar	-10°C → +50°C		✓	81513612	ExII2GDcIIIB55°CT6	INERIS 17567/04
	2 - 8 bar	-5°C → +50°C	MH15085	✓			
	2 - 8 bar	-5°C → +50°C	MH15085	✓			
	2 - 8 bar	-5°C → +50°C	MH15085	✓			
	2 - 8 bar	-5°C → +50°C	MH15085	✓			
	2 - 8 bar	-5°C → +50°C	MH15086	✓			
	3 - 8 bar	-10°C → +50°C		✓	81513234	ExII2GDcIIIB55°CT6	INERIS 17567/04
	3.5 - 8 bar	-10°C → +50°C		✓	81516107	ExII2GcIIIB55°CT6	INERIS 17564/04
	2 - 8 bar	-10°C → +50°C		✓	81516208	ExII2GcIIIB55°CT6	INERIS 17564/04
	3 - 10 bar	-10°C → +70°C		✓			
	3 - 10 bar	-10°C → +70°C		✓			
	3 - 10 bar	-10°C → +70°C		✓			
	3 - 10 bar	-10°C → +70°C		✓			
	2 - 8 bar	-10°C → +50°C		✓	81513039	ExII2GDcIIIBT6	INERIS 17564/04
	2 - 8 bar	-10°C → +50°C		✓	81513040	ExII2GDcIIIBT6	INERIS 17564/04
	2 - 8 bar	-10°C → +50°C		✓			
	2 - 8 bar	-10°C → +50°C		✓	81513075	ExII1GExialICT6	LCIE 02ATEX6121X
	2 - 8 bar	-10°C → +50°C		✓	81513076	ExII1GExialICT6	LCIE 02ATEX6121X
	2 - 8 bar	-10°C → +50°C		✓	81516085	Accessory <sup>(2)</sup>	INERIS 17564/04
	2 - 8 bar	-10°C → +50°C		✓	81517106	Accessory <sup>(2)</sup>	LCIE 02ATEX6121X
	2 - 8 bar	-10°C → +50°C		✓	81517206	Accessory <sup>(2)</sup>	LCIE 02ATEX6121X
	3 - 10 bar	-10°C → +60°C		✓			
	3 - 10 bar	-10°C → +60°C		✓			

<sup>(2)</sup> Accessory is ATEX approved if used with an ATEX product.





▶ Assembled modules

**Solenoid valves**  
catalogue pages 6 and 7

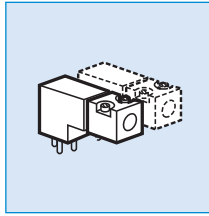

+ *Option* →

**LED**  
catalogue pages 20 and 21

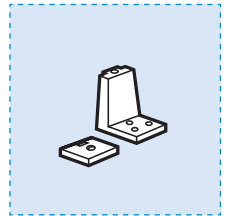

+ + +

**Valve modules**  
catalogue pages 20 to 25

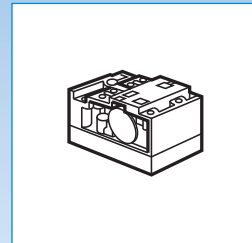
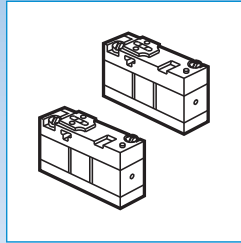
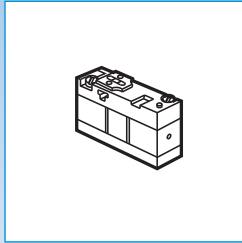

+

+

+

**Sub-bases**  
catalogue pages 20 to 25

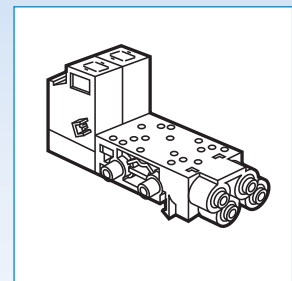
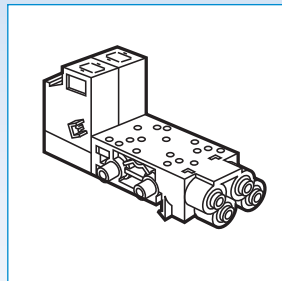
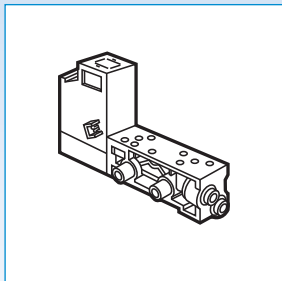

Single

Double

Double

=

=

=

**Final assembly**

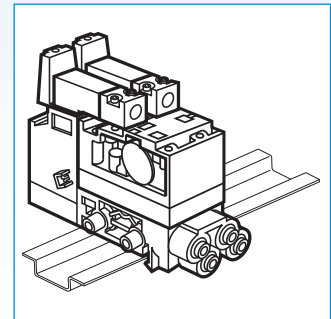
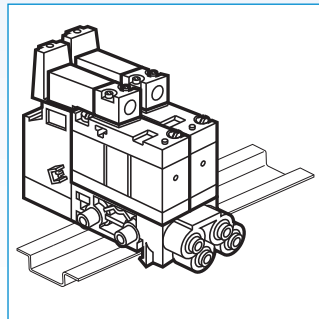
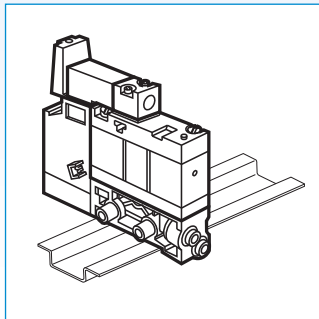

*NB: End bases are supplied on request only.*

## ▶ Valve module functions

### The various functions and their symbols as specified in ISO 1219

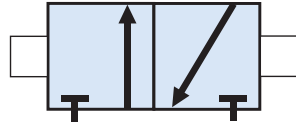

3/2 NC valve module

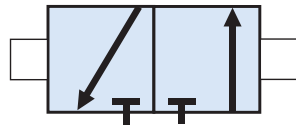

3/2 NO valve module

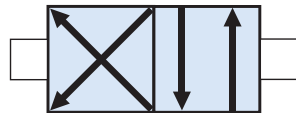

4/2 valve module

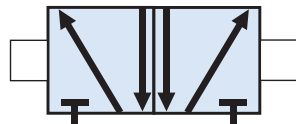

5/2 valve module

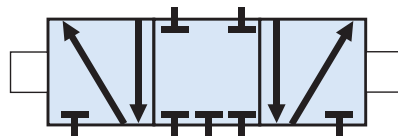

5/3 valve module, closed centre

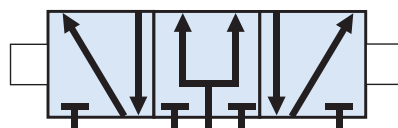

5/3 valve module, centre open to pressure

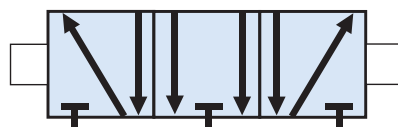

5/3 valve module, centre open for exhaust



▶ Simulation kit

▶ These kits have been designed to simplify wiring and assembly operations for the modules they contain. They can be used for simulating the principal simple automation systems and for studying the technology of pneumatic elements

Product	Part number	Type	Weight	Characteristics
<b>Basic kit</b>				
Standard				
	81598940	Basic PUMA	30 kg	<input type="checkbox"/> Latching sequencer module set <input type="checkbox"/> 1 set of logic elements <input type="checkbox"/> 1 set of peripheral elements <input type="checkbox"/> 1 set of 8 buttons <input type="checkbox"/> 1 set of 8 indicators <input type="checkbox"/> 1 bare console <input type="checkbox"/> 1 power front panel (3 cylinders + valve modules + position detectors)
<b>Extension module</b>				
Standard				
	81598941	Supplementary PUMA kit	4 kg	<input type="checkbox"/> 2 sets of electro-pneumatic interfaces <input type="checkbox"/> 1 set of pneumatic-electrical interfaces

The modular relays are configured so that users can explore logic functions and produce simple or complex automation systems by direct installation.

**Possible uses for simulation kits**

- Study and demonstration of basic logic functions
- Study and implementation with sequencer modules
- Study of peripheral or additional functions (timers, pulse generators, amplifiers, detectors, etc.)
- Study and demonstration of combinational or sequential logic problems
- Creation of control systems with 3 or 4 cylinders (2 or 4 sensors)

*NB: For specific applications, please consult us.*

**Dimensions of standard simulation kit**

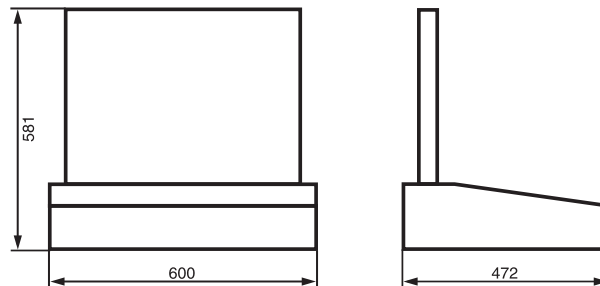

# Simulation and training materials

## Pressures and flow-rates

The rate of flow  $Q$  through a pipe or valve is given by the following formula:

$$Q = K_v \sqrt{(\Delta p / \gamma)}$$

where:

$Q$  = flow rate (L/min)  
 $\Delta p$  = pressure drop (bar)  
 $\gamma$  = density of liquid (kg/dm<sup>3</sup>)  
 $K_v$  = flow factor for the valve  
 For water:  $\gamma = 1 \text{ kg/dm}^3$

### Pressures

1 bar = 1.02 kg/cm<sup>2</sup> = 0.98 atm = 10<sup>5</sup> Pa = 100 kPa  
 = 14.51 psi

1 psi = 0.0689 bar = 0.0703 kg/cm<sup>2</sup>

### Flow rates

$K_v$  in L/min/ $\Delta p = 1 \text{ bar}$

$C_v$  in gpm/ $\Delta p = 1 \text{ psi}$

1  $K_v = 14.28 C_v$

1  $C_v = 0.07 K_v$

### Flow rate curves

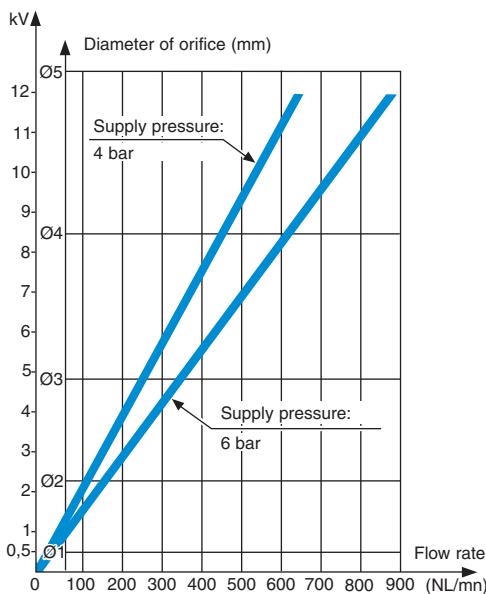

### Table of correlations between the various flow coefficients

	S	$k_v$	$K_v$	$C_v$	f
S	1	0.794	0.048	0.055	0.046
$k_v$	1.259	1	0.06	0.07	0.058
$K_v$	20.98	16.67	1	1.166	1.035
$C_v$	18	14.3	0.858	1	0.829
f	21.7	17.24	0.967	1.206	1

**Factor  $k_v$ :**  $k_v = 1$  when 1 litre of water per minute flows through a valve and causes a loss of pressure of 1 bar

**Factor  $K_v$ :** same definition as for factor  $k_v$ , but the flow rate is measured in m<sup>3</sup> per second

**Factor  $C_v$ :** same definition as for factor  $k_v$ , but the flow rate is measured in US gallons at 60°F and the loss of pressure is 1 psi

**Factor f:** same definition as factor  $C_v$ , but the flow rate is measured in Imperial gallons

**Equivalent cross-section S** corresponds to a theoretical port (whose cross-section is expressed in mm<sup>2</sup>), located in a pipe and giving rise to the same restriction as the valve in question.





▶ General

▶ Principles of Directive 94/9/EC

The directive aims to harmonise the legislation of European Union member states in order to ensure free circulation of equipment intended for use in explosive atmospheres (gas and dust). Since 1 July 2003, this directive has applied to electrical, mechanical, hydraulic and pneumatic products.

It concerns the assessment of protective devices and systems (manufacturers) as well as the design (design office), installation (installers, panel-builders) and maintenance (maintenance depts) of installations.

▶ Definition of an explosive atmosphere

*An explosive atmosphere is defined as a mixture of flammable substances (in the form of gas, vapour, mist or dust) with air under atmospheric conditions in which, after ignition, combustion spreads throughout the entire unburned mixture.*

▶ Application since 30 June 2003

- Manufacturers must offer products which comply with Directive 94/9/EC and must have a Quality Control System that has been approved by a notified body.
- Users are responsible for using equipment correctly according to the zones they have defined within their installations based on the potential risks. Existing installations must be brought into conformity with the ATEX Directive before 30 June 2006. All new products commissioned must comply with Directive 94/9/EC. In the event of breakdown, installed equipment that cannot be repaired must be replaced with equipment complying with Directive 94/9/EC.

▶ Classification

- Potentially explosive environments are classified by zone in compliance with Directive 1999/92/EC. This directive is aimed at users. It details the minimum requirements for increasing protection of the health and safety of workers exposed to explosive atmospheres.
- ATEX Directive 94/9/EC defines categories of equipment and protection systems which can be used in the corresponding zones.
  - Categories M1 and M2 relate to mines (group I)
  - Categories 1, 2 and 3 relate to other locations (group -II) often referred to as "Surface industries".

▶ Documents and recommendations/products

- ATEX-certified products must be supplied with an EC declaration of conformity and a user manual.
- At the time of sale, the sales representatives must check the zone in which the product is to be used. On the order, the customer must inform the manufacturer of the conditions of use.
- Manufacturers and distributors must ensure that their sales of ATEX products are traceable (so that customers who have been sold an ATEX product can be located in relation to the product's date of manufacture).
- In the case of an assembly, the product with the lowest certification level determines the level of the whole assembly.

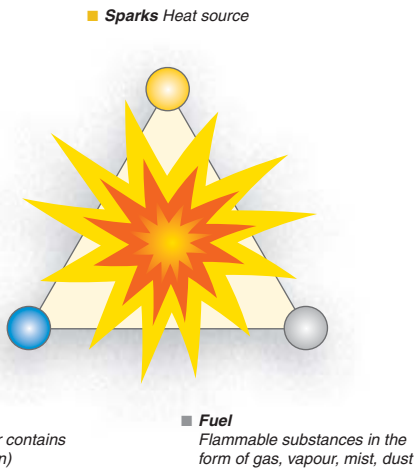

▶ Some relevant areas

Water treatment, chemical factories, silos, gas storage, ports, refineries, paper industry, paint factories, vehicles (if used in ATEX conditions), etc.





# ATEX Directive 94/9/EC

## ► Equipment definition

Equipment for surface industry - Group II						
Zone	0	20	1	21	2	22
Type of atmosphere G = Gas D = Dust	G	D	G	D	G	D
Presence Explosive atmosphere	<b>Continuous presence</b> (or for long periods, i.e. more than 1000 hours per year)		<b>Intermittent presence</b> (or occasional, i.e. 10 to 1000 hours per year)		<b>Fleeting presence</b> (or rare, i.e. 1 to 10 hours per year)	
Category of equipment that can be used according to 94/9/EC dated 23/03/94	1		2		3	

## ► Marking example

Certified products must incorporate marking specific to Directive 94/9/EC, such as:

CROUZET  
 Type: 81513530  
 Serial no:  
 Year of construction  
**CE 0081**  **II 1 G**  
**Ex ia II C T6**  
**LCIE 02 ATEX 6121 X**  
**Max. amb. T: +50°C**

## ► Explanation of the marking example

**CE 0081**  **II 1 G**

■ The **CE** marking followed by:

- the identification number of the body
- the **symbol**  indicating that this product is suitable for use in an explosive atmosphere
- the **equipment group** (II = surface industries)
  - the category: **1** = continuous presence; **2** = intermittent presence; **3** = fleeting presence
  - the type of explosive atmosphere (**G** = gas; **D** = dust).

*NB: In affixing this CE marking, the manufacturer declares that the product has been manufactured in complete conformity with the requirements of all the relevant directives.*

**Ex ia II C T6 X**

**Ex** : Symbol indicating that the equipment complies with one or more protection methods

**ia** : **Protection method**: intrinsic safety

**II** : **Group II** (locations other than mines subject to firedamp)

**C** : **Subdivision C**, including hydrogen, acetylene and carbon disulphide

**T6** : **Temperature class** corresponding to a maximum surface temperature of 85°C

**X** : Product subject to special conditions for safe usage, as specified on the notice

Gas group

**LCIE 02 ATEX 6121 X**

■ The CE Test **Certificate** type reference (if appropriate).

**Max. amb. T: +50°C**

■ The **ambient operating temperature** range.

■ In the event of use in an explosive atmosphere caused by dust, the following items are added to the marking:

- The surface limit **temperature T °C** for use in an explosive atmosphere caused by dust.
- The **IP** rating (only for dust).



► Available catalogue

► Discover our complete offer of ATEX explosive environment products in our **"Pneumatic Products in Explosive Atmospheres"** catalogue

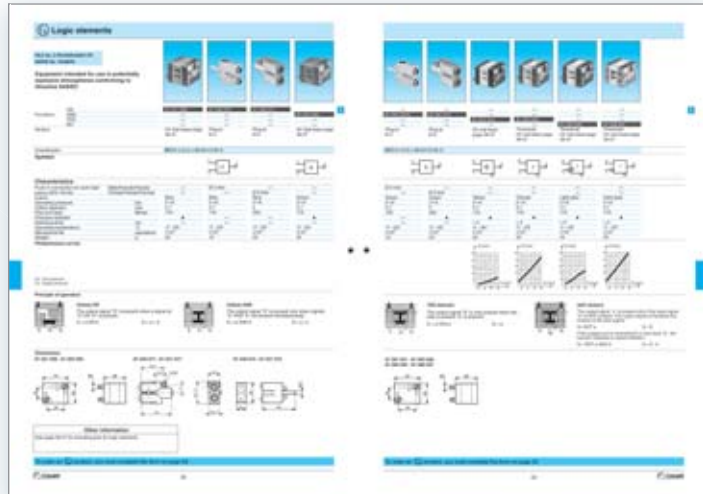

In it you will find all the technical information, standards, directives, part numbers and selection guides:

- Manual control valves
- Position detectors
- Pressure detectors and amplifiers
- Logic elements and automation controls
- Electro-pneumatic valves
- Vacuum-handling components

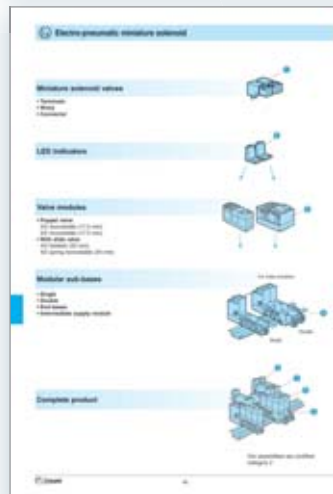

**Crouzet** FAX Form

Department: \_\_\_\_\_ Tel.: \_\_\_\_\_ Fax: \_\_\_\_\_

S-mail: \_\_\_\_\_ Date: \_\_\_\_\_

Ref. number: \_\_\_\_\_

Number of pages (including this one): \_\_\_\_\_

To: CROUZET AUTOMATIQUE Fax: five cover page

Re: Order for ATEX products for surface industries (group 9)

Product type:	
Part number:	
Operating area (p.26) (J1, J2, J3):	
Type of potentially explosive atmosphere (E2 and/or E3):	
Gas group (I: non-flammable explosive atmosphere in E2 category; II: flammable in E2 category)	
Maximum ambient operating temperature (T <sub>amb</sub> ):	
Maximum surface temperature (T <sub>amb</sub> ):	
IP rating if required (if potentially explosive atmosphere in E2):	
Net unit price:	
Quantity:	
Required delivery date:	
Order order price (VAT):	

Notes: \_\_\_\_\_

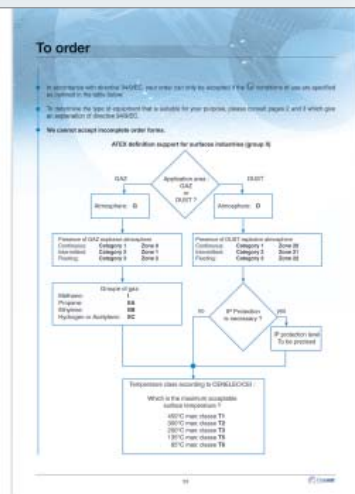



# Activity and website

## ► Crouzet & Pneumatics website

► For more information visit our website

- Presentation of the offer
- Adaptation
- Applications
- Selection guide

[www.crouzet.com](http://www.crouzet.com)



► And also

- Online electronic catalogue
- Free download of PDF documents







► List of part numbers

Industrial part no.	ATEX part no.	Type	Pages
24000000			
24679127		Pushbutton	7
24679128		Pushbutton	7
24679129		Pushbutton	7
24679171		Mushroom button	7
24679172		Mushroom button	7
24679173		Mushroom button	7
24679174		Symmetrical toggle	7
24679175		Lever toggle	7
24679176		Symmetrical toggle	7
24679177		Lever toggle	7
24679178		Symmetrical toggle	7
24679179		Lever toggle	7
24679180		Key toggle	7
24679181		Key toggle	7
24679182		Key toggle	7
24679701		Adaptor	7
70000000			
70507524		Flat lever	10
70507529		Roller lever	10
79000000			
79450609	79450609	Clips	14
79450618	79450618	Locking clips	14
79451698	79451698	Adaptor	12
79451903	79451903	Adaptor	12
79451904	79451904	Adaptor	12
79451905	79451905	Adaptor	12
79452103		Lever	10
79452104		Lever	10
79452123		Lever	10
79452124		Lever	10
79452133		Lever	10
79452445		Blanking plate	20
79452808	79458018	Capacity	14
79453569	79453569	CNOMO sub-base	20
79455614		Single plunger	6
79455615		Single plunger	6
79455616		Single plunger	6
79455617		Single plunger	6
79455618		Double plunger	6
79455619		Double plunger	6
79455628		3-position lever	6
79455629		3-position lever	6
79455630		3-position lever	6
79455631		3-position lever	6
79455632		Straight lever	9
79455633		Ball lever	9
79455634		Roller lever	9
79455635		Short roller lever	9
79455636		Single plunger	9
79455637		Roller plunger	9
81000000			
81280010		NO microvalve	6
81280510		NC microvalve	6
81281010		NO microvalve	6
81281510		NC microvalve	6
81282010		NO microvalve	6
81282510		NC microvalve	6
81283010		NO microvalve	6
81283510		NC microvalve	6
81290001	81290006	Low-force detector	10
81290501	81290506	Low-force detector	10
81371401		Special detector	10
81372201		Special detector	10
81372401		Special detector	10
81372901		Special detector	10
81501025	81501031	YES element	12
81501065	81501066	YES element	12
81502110	81502111	Vacuum switch	16
81502140	81502141	Pressure switch	16
81502150	81502151	Pressure switch	16

Industrial part no.	ATEX part no.	Type	Pages
81502160	81502162	Pressure switch	16
81502230	81502238	Amplifier	18
81502320	81502322	Amplifier	18
81502435	81502438	Relay for leak detector	18
81503025	81503028	YES element	12
81503540	81503543	Timer	12
81503710	81503728	Timer	12
81503716		Timer	12
81503720	81503729	Timer	12
81503725	81503731	Timer	12
81504025	81504035	NO element	12
81504025		Pressure decay sensor	10
81505110	81505111	Vacuum switch	16
81505140	81505141	Pressure switch	16
81505150	81505151	Pressure switch	16
81505160	81505164	Pressure switch	16
81505161		Pressure switch	16
81505230	81505231	Amplifier	18
81505320	81505321	Amplifier	18
81505435	81505437	Relay for leak detector	18
81506025	81506027	NO element	12
81506540	81506541	Timer	12
81506710	81506714	Timer	12
81506720	81506721	Timer	12
81506725	81506727	Timer	12
81506920		Frequency generator	12
81506940	81506945	Frequency generator	12
81506944		Frequency generator	12
81507540	81507543	Frequency generator	12
81507542		Frequency generator	12
81507720	81507724	Frequency generator	12
81508110		Vacuum switch	16
81508150		Pressure switch	16
81508160		Pressure switch	16
81509080		Pressure switch	16
81509085		Pressure switch	16
81510001		Amplifier relay	18
81512201		Special detector	10
81512401		Special detector	10
81513001	81513039	Supply module	24
81513011	81513040	End base	24
81513012		End base	24
81513052	81513052	LED	20
81513055		LED	20
81513058		LED	20
81513059		LED	20
81513060	81513075	Sub-base	24
81513064		Indicator seal	20
81513065	81513076	Sub-base	24
81513100	81513196	Valve module	24
81513200	81513234	Valve module	24
81513501		Pressure switch	16
81513502		Pressure switch	16
81513509		Pressure switch	16
81513510		Pressure switch	16
81513516		Pressure switch	16
81513518		Pressure switch	16
81513522		Vacuum switch	16
81513523		Vacuum switch	16
81513525		Vacuum switch	16
81513527		Vacuum switch	16
81513533		Pressure switch	16
81513535		Pressure switch	16
81513552		Pressure switch	16
81513561		Pressure switch	16
81513570		Pressure switch	16
81513574		Pressure switch	16
81513600	81513612	Valve module	24
81514101		Sub-base	20
81514161		Sub-base	20
81516081	81516093	Pneumatic pilot	20

# Index by part number

Industrial part no.	ATEX part no.	Type	Pages
81516082		Connector	20
81516085	81516085	Blanking plate	20
81516085	81516085	Blanking plate	24
81516100	81516107	Valve module	24
81516200	81516208	Valve module	24
81517101	81517106	Sub-base	24
81517201	81517206	Sub-base	24
81519031	81519034	Miniature solenoid valve	20
81519032	81519035	Miniature solenoid valve	20
81519052		Miniature solenoid valve	20
81519060		Miniature solenoid valve	20
81519080		Miniature solenoid valve	20
81519132		Miniature solenoid valve	20
81519331	81519334	Miniature solenoid valve	20
81519332	81519335	Miniature solenoid valve	20
81519333		Miniature solenoid valve	20
81519378		Miniature solenoid valve	20
81519379		Miniature solenoid valve	20
81519380		Miniature solenoid valve	20
81519381		Miniature solenoid valve	20
81519631	81519634	Miniature solenoid valve	20
81519632	81519635	Miniature solenoid valve	20
81519678		Miniature solenoid valve	20
81519679		Miniature solenoid valve	20
81519680		Miniature solenoid valve	20
81519681		Miniature solenoid valve	20
81519732		Valve module	24
81519774		Valve module	24
81519776		Valve module	24
81519777		Valve module	24
81519832		Valve module	24
81520601	81520602	Plug element	14
81521501	81521508	OR element	12
81522501	81522505	AND element	12
81523201	81523205	Memory	12
81523601	81523608	Memory	12
81525101	81525106	Flow restrictor	14
81526001	81526006	Flow restrictor	14
81527001		Mini-regulator	14
81529003	81529013	Flow restrictor	14
81529004	81529014	Flow restrictor	14
81529005	81529015	Flow restrictor	14
81529006	81529016	Flow restrictor	14
81529007	81529017	Flow restrictor	14
81529008	81529018	Flow restrictor	14
81529010	81529020	Flow restrictor	14
81529025	81529026	Flow restrictor	14
81529901	81529907	Non-return	14
81531001	81531008	Sub-base	14
81532001	81532009	Sub-base	14
81532102	81532109	Sub-base	14
81532104	81532111	Sub-base	14
81533001	81533001	Clip domino	14
81533501	81533501	Hole domino	14
81535301	81535303	Vacuum generator	18
81536801	81536804	Supply base	14
81537001		Silencer	20
81537201		Silencer	20
81540001	81540015	OR element	12
81540005	81540017	OR element	12
81541001	81541015	AND element	12
81541005	81541017	AND element	12
81542002	81542004	Sub-base	14
81543006		Sub-base	24
81543206		Sub-base	24
81545001	81545012	Vacuum generator	18
81545005	81545013	Vacuum generator	18
81546001		Miniature solenoid valve	22
81547001		Miniature solenoid valve	22
81547501		Miniature solenoid valve	22
81548010		Miniature solenoid valve	22
81549002		Miniature solenoid valve	22
81549010		Miniature solenoid valve	22
81549502		Miniature solenoid valve	22

Industrial part no.	ATEX part no.	Type	Pages
81549510		Miniature solenoid valve	22
81550001	81550013	Sequencer module	12
81550201	81550213	Sequencer module	12
81550401	81550403	Sequencer module	12
81550601	81550603	Sequencer module	12
81551001	81551004	Sub-base	14
81551101	81551104	Sub-base	14
81552001	81552005	Sub-base	14
81552101	81552105	Sub-base	14
81552601	81552605	Diversion base	14
81580101		Pneumatic relay	18
81580202		Pneumatic relay	18
81580503		Two-hand control module	18
81580504		Two-hand control module	18
81921501		Miniature detector	10
81921505		Miniature detector	10
81921601		Miniature detector	10
81921701		Miniature detector	10
81921702		Miniature detector	10
81921707		Miniature detector	10
81921712		Miniature detector	10
81921714		Miniature detector	10
81921716		Miniature detector	10
81921717		Miniature detector	10
81921718		Miniature detector	10
81921719		Miniature detector	10
81921806		Miniature detector	10
81921814		Miniature detector	10
81921901		Miniature detector	10
81921902		Miniature detector	10
81921911		Miniature detector	10
81921912		Miniature detector	10
81922010		Compact detector	10
81922205		Compact detector	10
81922210		Compact detector	10
81922211		Compact detector	10
81922401		Compact detector	10
81922521		Compact detector	10
81923001		Special detector	10
81999501		Control pedal	18
84000000			
84150201	84150214	Indicator	18
84150202	84150215	Indicator	18
84150203	84150216	Indicator	18
84150204	84150217	Indicator	18
89000000			
89538201		Counter	18
89541007		Valve module	24
89541037		Valve module	24
89541047		Valve module	24
89541067		Valve module	24
89544001		3/2 NO valve	7
89544201		3/2 NO valve	7
89544501		3/2 NC valve	7
89544701		3/2 NC valve	7
89545005		3/2 NO valve + adaptor	7
89545105		3/2 NF valve + adaptor	7
89545205		3/2 NF valve + 3/2 NO valve + adaptor	7
89545305		3/2 NF valve + 3/2 NF valve + adaptor	7
99000000			
99766001		Counter	18
99766002		Counter	18
	81519047	Miniature solenoid valve + connector	20
	81519048	Miniature solenoid valve + connector	20
	81519347	Miniature solenoid valve + connector	20
	81519348	Miniature solenoid valve + connector	20
	81519647	Miniature solenoid valve	20
	81519648	Miniature solenoid valve + connector	20



## AMERICA



**BRAZIL**  
**CST Latinoamerica**  
 Alameda Rio Negro,  
 1.084 - cj.A31  
 Centro Empresarial de Alphaville  
 CEP: 06454-000 Barueri - SP  
 BRASIL  
 Tel. : +55 (11) 4191 9797  
 Fax : +55 (11) 4191 9136  
 E-mail : info@cst-latinoamerica.com  
 www.crouzet.com.br



**MEXICO**  
**Automatismo Crouzet S.A. de C.V.**  
 Calzada Zavaleta 2505 - C  
 Col Sta Cruz Buenavista  
 C.P. 72150 - Puebla  
 MEXICO  
 Tel. : +52 (222) 409 7000  
 Fax : +52 (222) 409 7810  
 01 800 087 6333  
 E-mail : info-crouzet.mexicana@us.crouzet.com  
 www.crouzet.com



**USA/CANADA**  
**Crouzet North America**  
 204 Airline Drive, suite 300  
 75019 Coppell Texas  
 USA  
 Tel. : +1 (972) 471 2565  
 Fax : +1 (972) 471 2560  
 E-mail : customer.service@us.crouzet.com  
 www.crouzet-usa.com



**OTHER COUNTRIES**  
**Crouzet do Brasil Ltda**  
 Rua Gal.Furtado Nascimento,  
 740 - sala 77  
 Alto de Pinheiros / 05465-070  
 São Paulo - SP  
 BRASIL  
 Tel. : +55 (11) 3026 9008  
 Fax : +55 (11) 3026 9009  
 E-mail : crz-infobrasil@crouzet.com  
 www.crouzet.com.br

## EUROPE MIDDLE EAST AFRICA



**AUSTRIA**  
**Crouzet GmbH**  
 Zweigniederlassung Österreich  
 Spengergasse 1/3  
 1050 Wien  
 ÖSTERREICH  
 Tel. : +43 (0) 1 36 85 471  
 Fax : +43 (0) 1 36 85 472  
 E-mail : info-direkt@crouzet.com  
 www.crouzet.at



**BELGIUM**  
**Crouzet NV/SA**  
 Dieweg 3 B  
 B - 1180 Uccle  
 BELGIUM  
 Tel. : +32 (0) 2 462 07 30  
 Fax : +32 (0) 2 461 00 23  
 E-mail : com-be@crouzet.com  
 www.crouzet.be

Creation-Design: Communication Crouzet  
 Editing-Publishing: SEDOC, Axxess  
 Photos-Graphics: Daniel Lattard, Schneider Electric  
 Printing: Imprimerie des Deux Ponts



**FRANCE**  
**Crouzet Automatismes SAS**  
 2 rue du Docteur Abel - BP 59  
 26902 Valence CEDEX 9  
 FRANCE  
 Tel. : +33 (0) 4 75 44 88 44  
 Fax : +33 (0) 4 75 55 98 03  
 E-mail : com-fr@crouzet.com  
 www.crouzet.fr

### Customer service

**N° Indigo 0 825 333 353**  
8 L18 € TTC / MN  
**N° Azur FAX 0 810 610 102**  
TRIP APPEL LOCAL



**GERMANY**  
**Crouzet GmbH**  
 Otto-Hahn-Str. 3, 40721 Hilden  
 Postfach 203, 40702 Hilden  
 DEUTSCHLAND  
 E-mail : info-direkt@crouzet.com  
 www.crouzet.de

### Customer service

Tel. : +49 (0) 21 03 9 80-108/176  
 Fax : +49 (0) 21 03 9 80-250  
 E-mail : info-direkt@crouzet.com



**ITALY**  
**Crouzet Componenti s.r.l.**  
 Via Viganò De Vizzi, 93/95  
 20092 Cinisello Balsamo (MI)  
 ITALIA  
 Tel. : +39 (02) 66 599 240  
 Fax : +39 (02) 66 599 248  
 E-mail : crz-it-pneu@crouzet.com  
 www.crouzet.it



**SPAIN/PORTUGAL**  
**Crouzet Ibérica**  
 C/ Aragón 224, 2º 2ª  
 08011 Barcelona  
 ESPAÑA  
 Tel. : +34 (93) 484 39 70  
 Fax : +34 (93) 484 39 73  
 E-mail : es-consultas@crouzet.es  
 www.crouzet.es



**THE NETHERLANDS**  
**Crouzet BV**  
 Industrierweg 17  
 2382 NR Zoeterwoude  
 NEDERLAND  
 Tel. : +31 (0) 71-581 20 30  
 Fax : +31 (0) 71-541 35 74  
 E-mail : com-nl@crouzet.com  
 www.crouzet.nl



**UNITED KINGDOM**  
**Crouzet Ltd**  
 Intec 3 Wade Road  
 Basingstoke Hampshire  
 RG24 8NE  
 UNITED KINGDOM  
 Tel. : +44 (0)1256 318 900  
 Fax : +44 (0)1256 318 901  
 E-mail : info@crouzet.co.uk  
 www.crouzet.co.uk



**SWITZERLAND**  
**Crouzet AG**  
 Gewerbebepark - Postfach 56  
 5506 Mägenwil  
 SCHWEIZ  
 Tel. : +41(0) 62 887 30 30  
 Fax : +41(0) 62 887 30 40  
 E-mail : info-direkt@crouzet.com  
 www.crouzet.ch



**OTHER COUNTRIES**  
**Crouzet Automatismes SAS**  
 2 rue du Docteur Abel - BP 59  
 26902 Valence CEDEX 9  
 FRANCE  
 Tel. : +33 (0) 475 802 102  
 Fax : +33 (0) 475 448 126  
 E-mail : com-ex@crouzet.com  
 www.crouzet.com

## ASIA PACIFIC

**CHINA & HONG-KONG**  
**Custom Sensors and Technologies Asia (Shanghai) Limited**  
 2 Floor, Innovation Building  
 No. 1009, Yi Shan Road  
 Shanghai 200233  
 CHINA  
 Tel. : +86 (21) 2401 7766  
 Fax : +86 (21) 6249 0701  
 E-mail : com-cn@cn.crouzet.com  
 www.crouzet.cn

**INDIA**  
**Crouzet India**  
 Prestige Meridian II  
 No. 30, 13th Floor,  
 Unit No: 1301 & 1302  
 Mahatma Gandhi Road  
 Bangalore 560 001  
 INDIA  
 Tel.: +91 (0) 80 41132204/05  
 Fax : +91 (80) 41132206  
 E-mail : crz\_bangalore@crouzet.com  
 www.crouzet.co.in

**TAIWAN**  
**Custom Sensors & Technologies**  
 3F, No. 39, Ji-Hu Road  
 Nei-Hu Dist. - Taipei 114  
 TAIWAN  
 Tel. : +886 2 8751 6388  
 Fax : +886 2 2657 8725  
 E-mail : com-tw@tw.crouzet.com  
 www.crouzet.tw

**SOUTH KOREA**  
**Custom Sensors & Technologies**  
 5F, Jeil Bldg.  
 94-46 Youngdeungpo-dong  
 7- ga Youngdeungpo-gu  
 Seoul, 150-037  
 SOUTH KOREA  
 Tel. : +82 2 2629 8312  
 Fax : +82 2 2629 8310  
 E-mail : Sales-tw@tw.crouzet.com  
 www.crouzet.com

**EAST ASIA & PACIFIC**  
**Custom Sensors & Technologies**  
 3F, No. 39, Ji-Hu Road  
 Nei-Hu Dist. - Taipei 114  
 TAIWAN  
 Tel. : +886 2 8751 6388  
 Fax : +886 2 2657 8725  
 E-mail : com-tw@tw.crouzet.com  
 www.crouzet.tw

**Warning:**  
 The product information contained in this catalogue is given purely as information and does not constitute a representation, warranty or any form of contractual commitment. CROUZET Automatismes and its subsidiaries reserve the right to modify their products without notice. It is imperative that we should be consulted over any particular use or application of our products and it is the responsibility of the buyer to establish, particularly through all the appropriate tests, that the product is suitable for the use or application. Under no circumstances will our warranty apply, nor shall we be held responsible for any application (such as any modification, addition, deletion, use in conjunction with other electrical or electronic components, circuits or assemblies, or any other unsuitable material or substance) which has not been expressly agreed by us prior to the sale of our products.

Headquartered in Moorpark, California-USA, **Custom Sensors & Technologies (CST)** is made up of the leading brands of Crouzet, Kavlico and Crydom, as well as the former divisions of BEI Technologies, including Newall and Systron Donner. CST provides sensors, controls, and actuation products to the transportation, industrial, and aerospace & defense markets.

[www.cstsensors.com](http://www.cstsensors.com)

Distributed by :

### Crouzet Automatismes SAS

2 rue du Docteur Abel - BP 59  
 26902 Valence CEDEX 9  
 FRANCE

[www.crouzet.com](http://www.crouzet.com)

CRZ BR 30/A  
 Ref. 6760100 EN  
 07/2008