

6

5

4

3

2

1

E

E

D

D

C

C

B

B

A

A

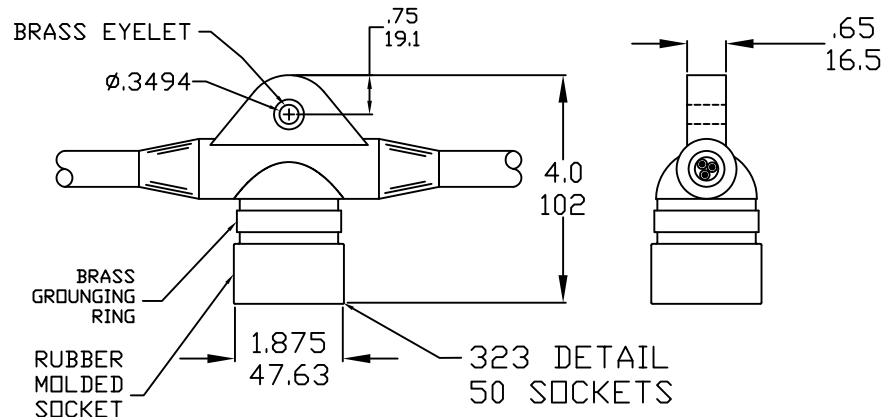
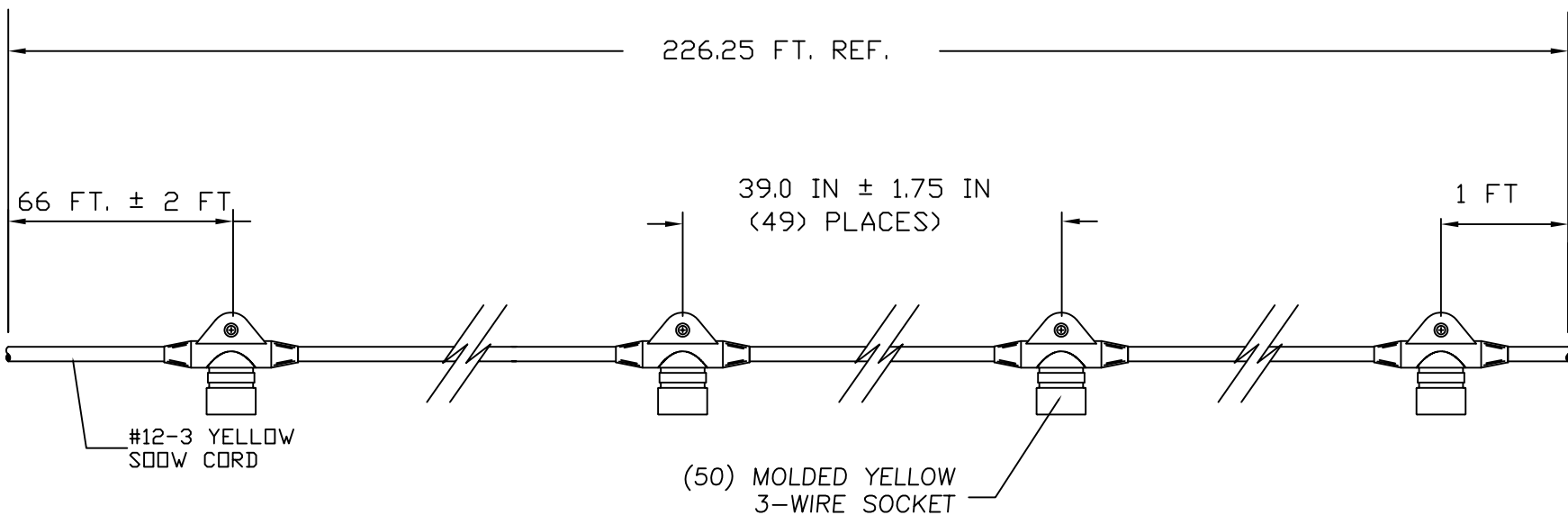

RELEASE DRAWING EC NO: WNA2010-0739 DRWN: TVICKERS 2010/06/02 CHKD: HK APPR: DTTITUS 2010/09/03 REV A	QUALITY SYMBOLS ▽=0 ∇=0	GENERAL TOLERANCES (UNLESS SPECIFIED)		DIMENSION STYLE IN/MM		SCALE NTS	DESIGN UNITS INCH	THIRD ANGLE PROJECTION		
			mm	INCH	DRAWN BY TVICKERS	DATE 2010/06/02	TITLE STRINGLIGHT 226.25 FT. (50) 323@39 IN. CENTERS 66 FT. LEAD & 1 FT TAIL			
		4 PLACES	±---	±---	CHECKED BY HK	DATE 2010/06/02	MOLEX INCORPORATED DOCUMENT NO. SD-130106-016 SHEET NO. 1 OF 1			
		3 PLACES	±---	±.005	APPROVED BY DTTITUS	DATE 2010/09/02				
2 PLACES	±0.13	±.010	MATERIAL NO. 1301060159							
1 PLACE	±0.25	±.020	ANGULAR ±.5°		DRAFT WHERE APPLICABLE MUST REMAIN WITHIN DIMENSIONS					
				SIZE A	THIS DRAWING CONTAINS INFORMATION THAT IS PROPRIETARY TO MOLEX INCORPORATED AND SHOULD NOT BE USED WITHOUT WRITTEN PERMISSION					

6

5

4

3

2

1