

650MHz, Gain of 5, Low Noise Amplifiers

The EL5134, EL5135, EL5234, and EL5235 are ultra-low voltage noise, high speed voltage feedback amplifiers that are ideal for applications requiring low voltage noise, including communications and imaging. These devices offer extremely low power consumption for exceptional noise performance. Stable at gains as low as 5, these devices offer 100mA of drive performance. Not only do these devices find perfect application in high gain applications, they maintain their performance down to lower gain settings.

These amplifiers are available in small package options (SOT-23) as well as the MSOP and the industry-standard SO packages. All parts are specified for operation over the -40°C to +85°C temperature range.

Features

- 650MHz -3dB bandwidth
- $A_v = +5$ stable
- Ultra low noise $1.5\text{nV}/\sqrt{\text{Hz}}$ and $0.9\text{pA}/\sqrt{\text{Hz}}$
- 450V/ μs slew rate
- Low supply current = 6.7mA per amplifier
- Single supplies from 5V to 12V
- Dual supplies from $\pm 2.5\text{V}$ to $\pm 5\text{V}$
- Fast disable on the EL5134 and EL5234
- Duals EL5234 and EL5235
- Low cost
- Pb-free plus anneal available (RoHS compliant)

Applications

- Imaging
- Instrumentation
- Communications devices

Ordering Information

PART NUMBER	PART MARKING	TAPE & REEL	PACKAGE	PKG. DWG. #
EL5134IS	5134IS	-	8 Ld SOIC (150 mil)	MDP0027
EL5134IS-T7	5134IS	7"	8 Ld SOIC (150 mil)	MDP0027
EL5134IS-T13	5134IS	13"	8 Ld SOIC (150 mil)	MDP0027
EL5134ISZ (Note)	5134ISZ	-	8 Ld SOIC (150 mil) (Pb-Free)	MDP0027
EL5134ISZ-T7 (Note)	5134ISZ	7"	8 Ld SOIC (150 mil) (Pb-Free)	MDP0027
EL5134ISZ-T13 (Note)	5134ISZ	13"	8 Ld SOIC (150 mil) (Pb-Free)	MDP0027
EL5135IW-T7	BDAA	7" (3k pcs)	5 Ld SOT-23	MDP0038
EL5135IW-T7A	BDAA	7" (250 pcs)	5 Ld SOT-23	MDP0038
EL5135IWZ-T7 (Note)	BTAA	7" (3k pcs)	5 Ld SOT-23 (Pb-Free)	MDP0038
EL5135IWZ-T7A (Note)	BTAA	7" (250 pcs)	5 Ld SOT-23 (Pb-Free)	MDP0038
EL5234IY	BWAAA	-	10 Ld MSOP (3.0mm)	MDP0043
EL5234IY-T7	BWAAA	7"	10 Ld MSOP (3.0mm)	MDP0043
EL5234IY-T13	BWAAA	13"	10 Ld MSOP (3.0mm)	MDP0043
EL5235IS	5235IS	-	8 Ld SOIC (150 mil)	MDP0027
EL5235IS-T7	5235IS	7"	8 Ld SOIC (150 mil)	MDP0027
EL5235IS-T13	5235IS	13"	8 Ld SOIC (150 mil)	MDP0027

NOTE: Intersil Pb-free plus anneal products employ special Pb-free material sets; molding compounds/die attach materials and 100% matte tin plate termination finish, which are RoHS compliant and compatible with both SnPb and Pb-free soldering operations. Intersil Pb-free products are MSL classified at Pb-free peak reflow temperatures that meet or exceed the Pb-free requirements of IPC/JEDEC J STD-020.

Pinouts

EL5134
(8 LD SOIC)
TOP VIEW

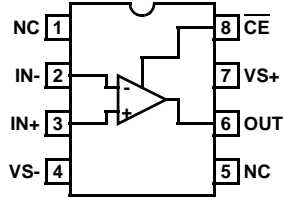

EL5135
(5 LD SOT-23)
TOP VIEW

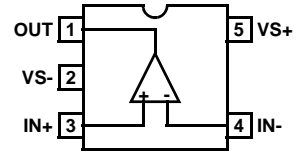

EL5234
(10 LD MSOP)
TOP VIEW

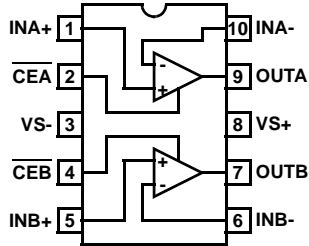

EL5235
(8 LD SOIC)
TOP VIEW

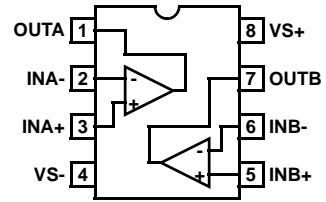

EL5134, EL5135, EL5234, EL5235

Absolute Maximum Ratings (T_A = +25°C)

Supply Voltage from V _{S+} to V _{S-}	13.2V
SR, Supply Rate of Supply Voltage Slew Rate	1V/μs
I _{IN-} , I _{IN+} , CE	±5mA
Continuous Output Current	100mA
Power Dissipation	See Curves

Thermal Information

Storage Temperature	-65°C to +125°C
Operating Temperature	-40°C to +85°C
Operating Junction Temperature	+125°C
Pb-free reflow profile	see link below
	http://www.intersil.com/pbfree/Pb-FreeReflow.asp

CAUTION: Stresses above those listed in "Absolute Maximum Ratings" may cause permanent damage to the device. This is a stress only rating and operation of the device at these or any other conditions above those indicated in the operational sections of this specification is not implied.

IMPORTANT NOTE: All parameters having Min/Max specifications are guaranteed. Typical values are for information purposes only. Unless otherwise noted, all tests are at the specified temperature and are pulsed tests, therefore: T_J = T_C = T_A

Electrical Specifications V_{S+} = +5V, V_{S-} = -5V, A_v = +5, R_F = 100Ω, R_G = 25Ω, R_L = 500Ω, T_A = +25°C, unless otherwise specified.

PARAMETER	DESCRIPTION	CONDITIONS	MIN	TYP	MAX	UNIT
V _{OS}	Offset Voltage		-1	0.2	1	mV
		EL5234		0.3	±1.5	mV
T _C V _{OS}	Offset Voltage Temperature Coefficient	Measured from T _{MIN} to T _{MAX}		-0.8		μV/°C
I _B	Input Bias Current	V _{IN} = 0V	2.5	3.7	5.5	μA
I _{OS}	Input Offset Current	V _{IN} = 0V	-0.7	0.3	0.7	nA
T _C I _{OS}	Input Bias Current Temperature Coefficient	Measured from T _{MIN} to T _{MAX}		-3		nA/°C
PSRR	Power Supply Rejection Ratio	V _{S+} = 4.75V to 5.25V	75	85		dB
CMRR	Common Mode Rejection Ratio	V _{CM} = ±3V	80	108		dB
CMIR	Common Mode Input Range	Guaranteed by CMRR test	±3	±3.3		V
R _{IN}	Input Resistance	Common mode	5	16		MΩ
C _{IN}	Input Capacitance			1		pF
I _S	Supply Current, per amplifier		5.6	6.7	7.8	mA
AVOL	Open Loop Gain	R _L = 1kΩ to GND	4.0	8.0		kV/V
V _O	Voltage Swing	R _L = 1kΩ, R _F = 900Ω, R _G = 100Ω	±3.5	3.9		V
		R _L = 150Ω, R _F = 900Ω, R _G = 100Ω	±3.3	3.65		V
I _{SC}	Short Circuit Current	R _L = 10Ω	70	140		mA
BW-3dB	-3dB Bandwidth	A _V = 5, R _L = 1kΩ		650		MHz
BW-0.1dB	±0.1dB Bandwidth	A _V = 5, R _L = 1kΩ		40		MHz
GBWP	Gain Bandwidth Product			1500		MHz
PM	Phase Margin	R _L = 1kΩ, C _L = 6pF		55		°
SR	Slew Rate	V _S = +5V, R _L = 150Ω, V _{OUT} = 0V to 3V	350	475		V/μs
t _R	Rise Time	±0.1V _{STEP}		1.75		ns
t _F	Fall Time	±0.1V _{STEP}		1.75		ns
OS	Overshoot	±0.1V _{STEP}		25		%
t _S	0.01% Settling Time			14		ns
dG	Differential Gain	A _V = 5, R _F = 1kΩ		0.12		%
dP	Differential Phase	A _V = 5, R _F = 1kΩ		0.08		°
e _N	Input Noise Voltage	f = 10kHz		1.5		nV/√Hz
i _N	Input Noise Current	f = 10kHz		0.9		pA/√Hz

EL5134, EL5135, EL5234, EL5235

Electrical Specifications $V_{S+} = +5V$, $V_{S-} = -5V$, $A_v = +5$, $R_F = 100\Omega$, $R_G = 25\Omega$, $R_L = 500\Omega$, $T_A = +25^\circ C$, unless otherwise specified.

PARAMETER	DESCRIPTION	CONDITIONS	MIN	TYP	MAX	UNIT
SUPPLY (EL5134, EL5234)						
I_{SOFF+}	Supply Current - Disabled, per Amplifier		0	+12	+25	μA
I_{SOFF-}	Supply Current - Disabled, per Amplifier	No load, $V_{IN} = 0V$	-25	-12	0	μA
ENABLE (EL5134, EL5234)						
I_{IHCE}	\overline{CE} Pin Input High Current	$\overline{CE} = +5V$	1	10	+25	μA
I_{ILCE}	\overline{CE} Pin Input Low Current	$\overline{CE} = 0V$	-1	0	+1	μA
V_{IHCE}	\overline{CE} Input High Voltage for Power-down		$V_{S+} - 1$			V
V_{ILCE}	\overline{CE} Input Low Voltage for Power-up				$V_{S+} - 3$	V

Applications Information

Typical Performance Curves

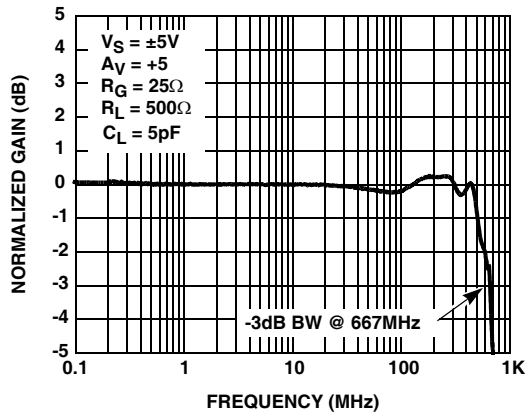

FIGURE 1. GAIN vs FREQUENCY

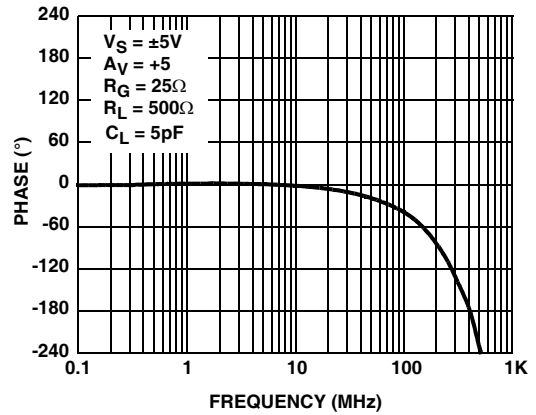

FIGURE 2. PHASE vs FREQUENCY

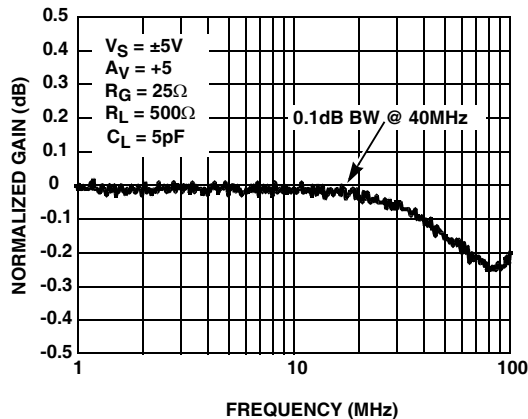

FIGURE 3. 0.1dB BANDWIDTH

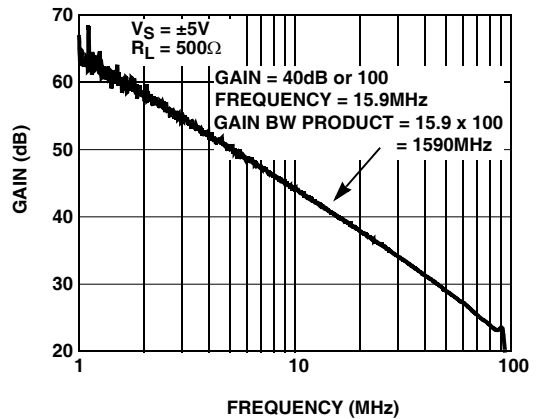

FIGURE 4. GAIN BANDWIDTH PRODUCT

Typical Performance Curves (Continued)

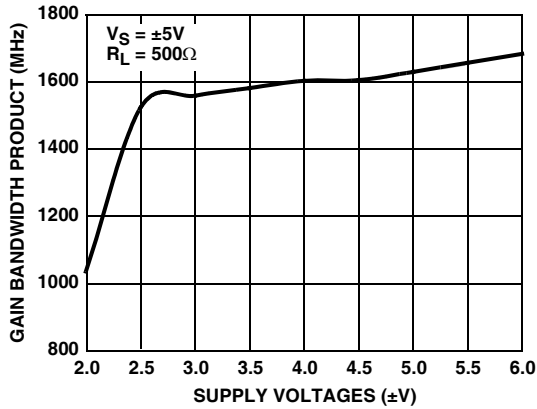

FIGURE 5. GAIN BANDWIDTH PRODUCT vs SUPPLY VOLTAGES

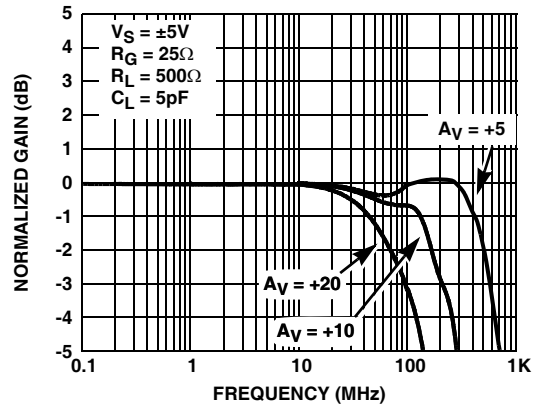

FIGURE 6. GAIN vs FREQUENCY FOR VARIOUS +A_V

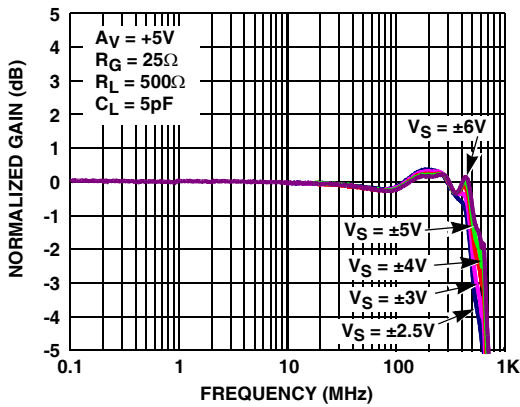

FIGURE 7. GAIN vs FREQUENCY FOR VARIOUS ±V_S

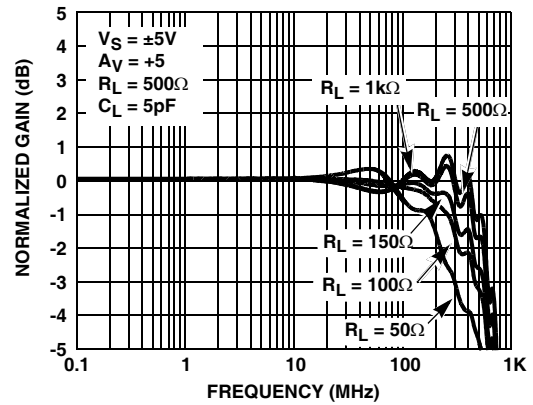

FIGURE 8. GAIN vs FREQUENCY FOR VARIOUS R_{LOAD}

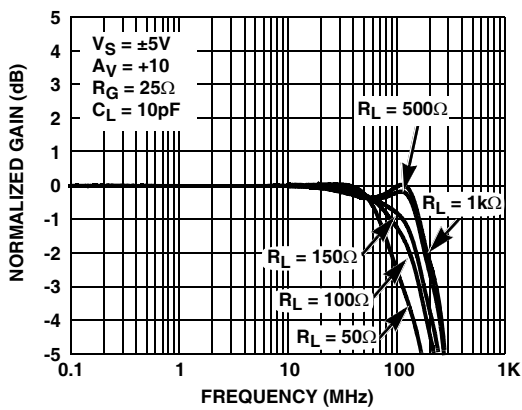

FIGURE 9. GAIN vs FREQUENCY FOR VARIOUS R_{LOAD} (A_V = +10)

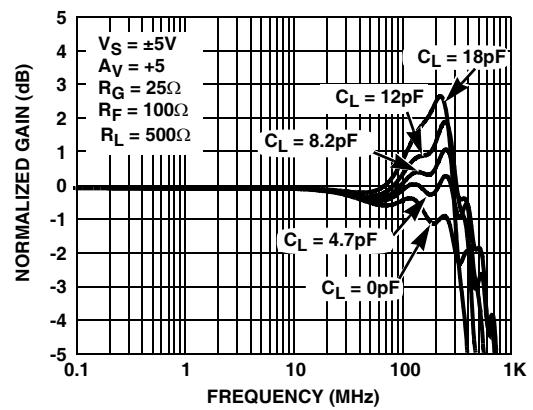

FIGURE 10. GAIN vs FREQUENCY FOR VARIOUS C_{LOAD} (A_V = +5)

Typical Performance Curves (Continued)

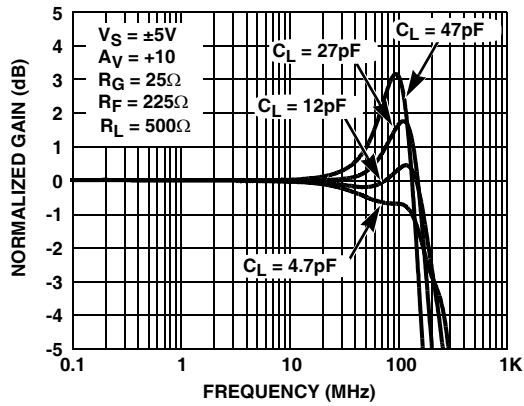

FIGURE 11. GAIN vs FREQUENCY FOR VARIOUS C_{LOAD} ($A_V = +10$)

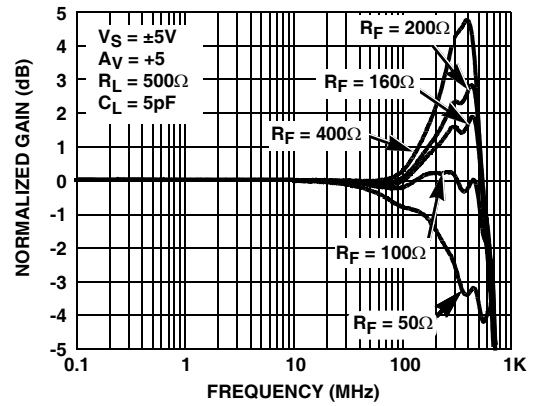

FIGURE 12. GAIN vs FREQUENCY FOR VARIOUS R_F ($A_V = +5$)

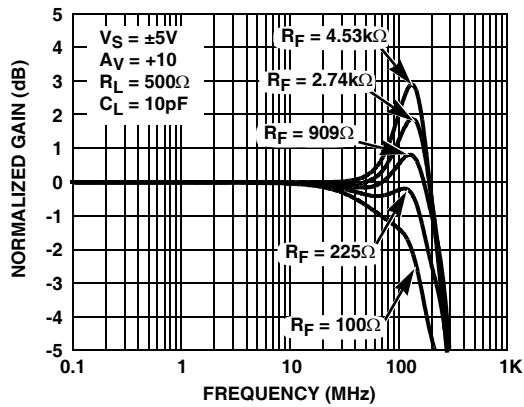

FIGURE 13. GAIN vs FREQUENCY FOR VARIOUS R_F ($A_V = +10$)

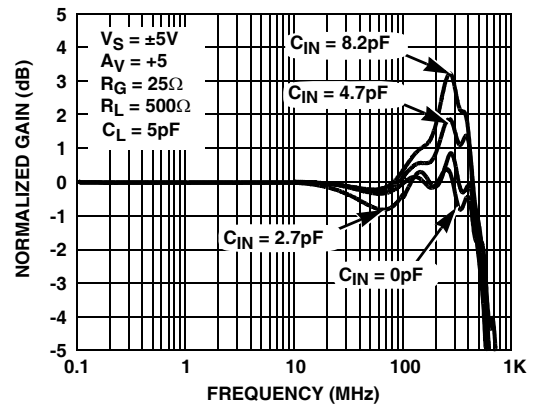

FIGURE 14. GAIN vs FREQUENCY FOR VARIOUS $C_{IN(-)}$ ($A_V = +5$)

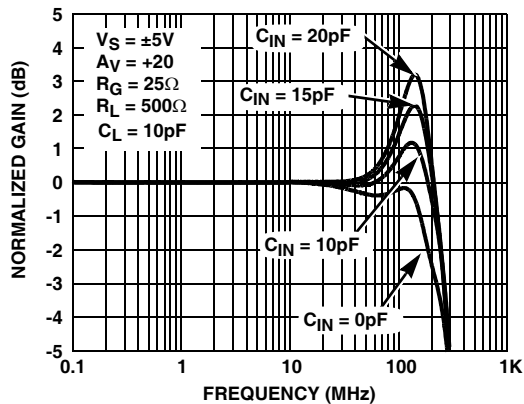

FIGURE 15. GAIN vs FREQUENCY FOR VARIOUS $C_{IN(-)}$ ($A_V = +10$)

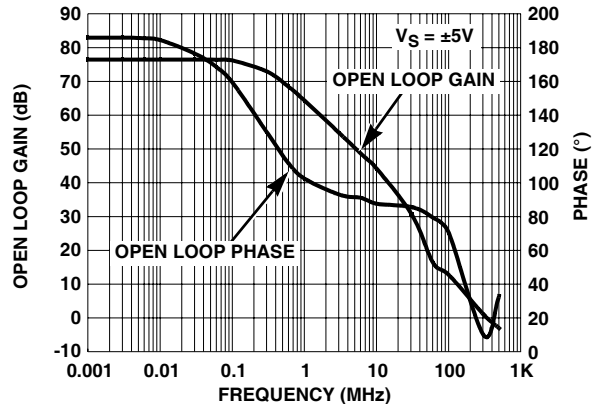

FIGURE 16. OPEN LOOP GAIN and PHASE vs FREQUENCY

Typical Performance Curves (Continued)

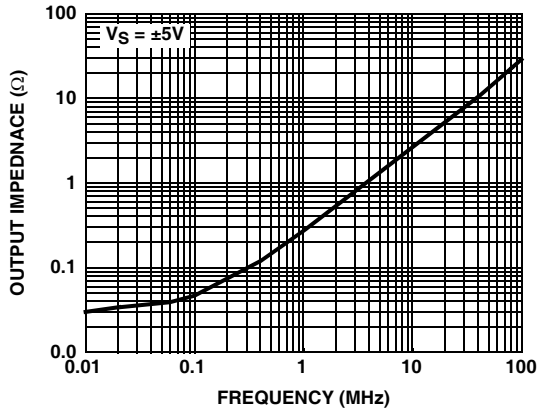

FIGURE 17. OUTPUT IMPEDANCE vs FREQUENCY

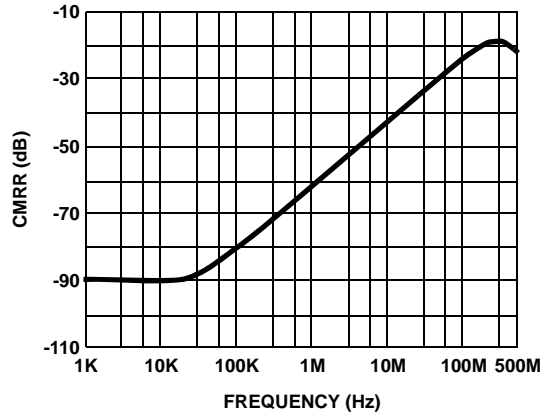

FIGURE 18. CMRR vs FREQUENCY

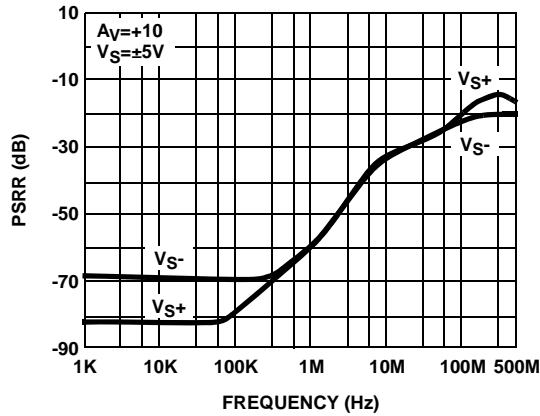

FIGURE 19. PSRR vs FREQUENCY

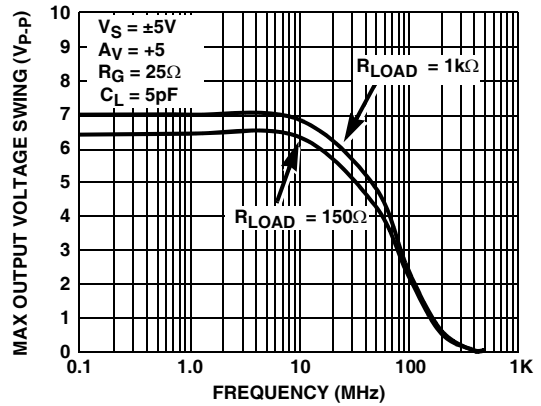

FIGURE 20. MAX OUTPUT VOLTAGE SWING vs FREQUENCY

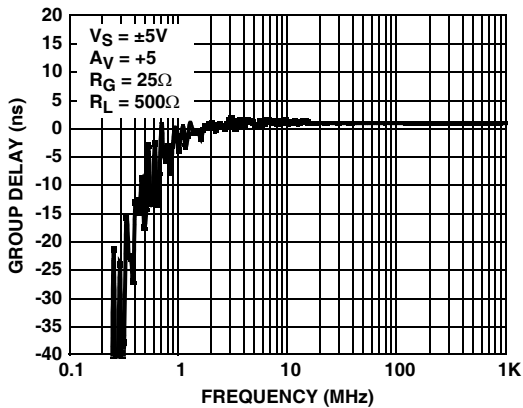

FIGURE 21. GROUP DELAY vs FREQUENCY

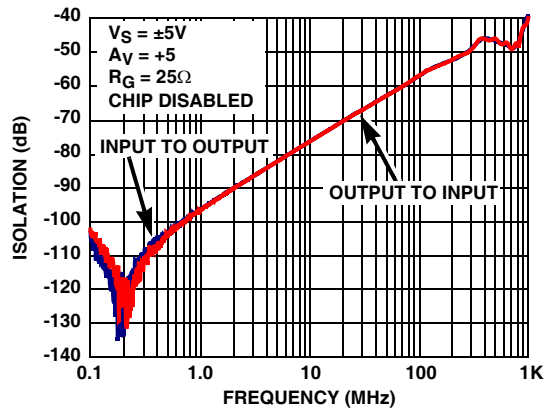

FIGURE 22. INPUT AND OUTPUT ISOLATION (EL5134, EL5234)

Typical Performance Curves (Continued)

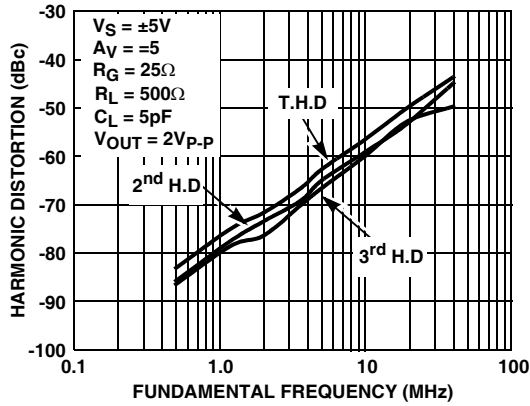

FIGURE 23. HARMONIC DISTORTION vs FREQUENCY

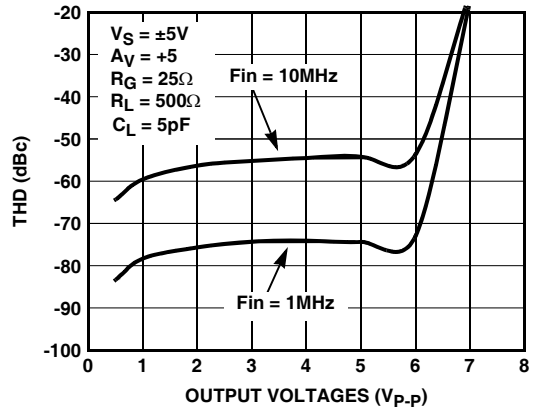

FIGURE 24. TOTAL HARMONIC DISTORTION vs OUTPUT VOLTAGES

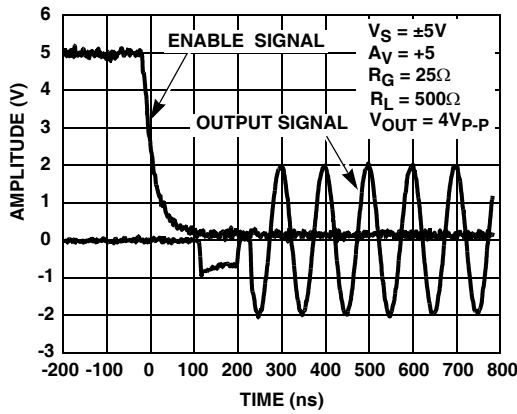

FIGURE 25. TURN-ON TIME (EL5134, EL5234)

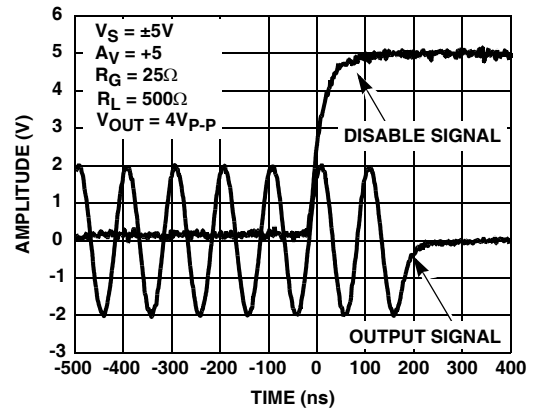

FIGURE 26. TURN-OFF TIME (EL5134, EL5234)

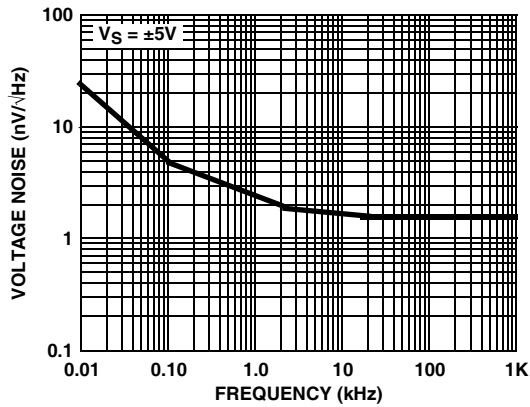

FIGURE 27. EQUIVALENT INPUT VOLTAGE NOISE vs FREQUENCY

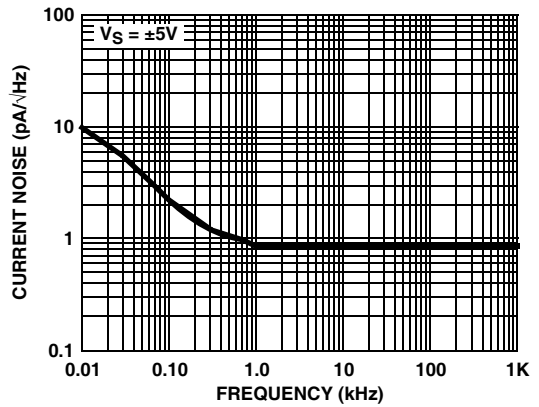

FIGURE 28. EQUIVALENT INPUT CURRENT NOISE vs FREQUENCY

Typical Performance Curves (Continued)

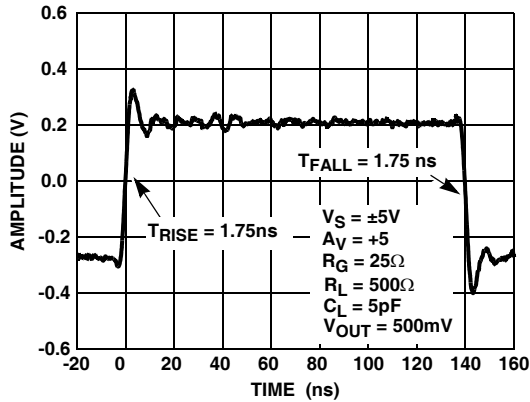

FIGURE 29. SMALL SIGNAL STEP RESPONSE_RISE AND FALL TIME

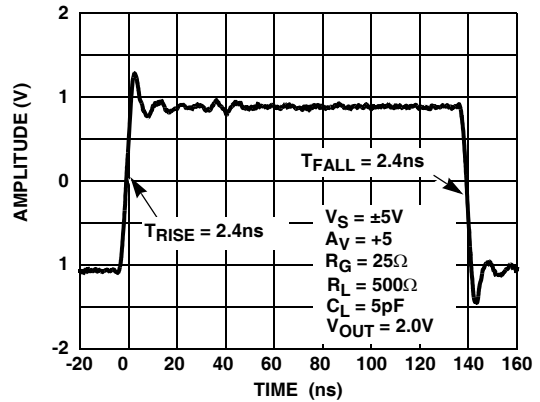

FIGURE 30. LARGE SIGNAL STEP RESPONSE_RISE AND FALL TIME

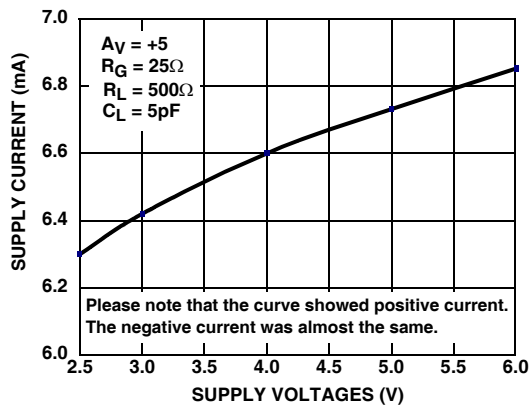

FIGURE 31. SUPPLY CURRENT vs SUPPLY VOLTAGE

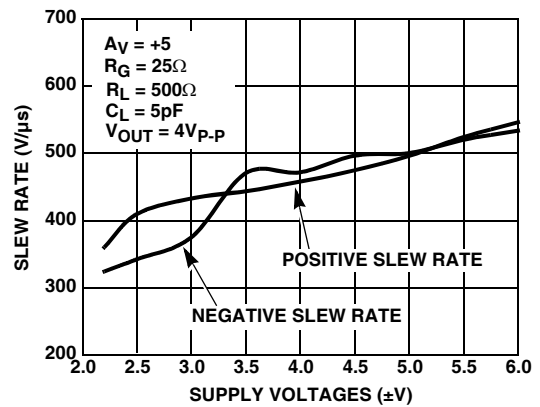

FIGURE 32. SLEW RATE vs SUPPLY VOLTAGES

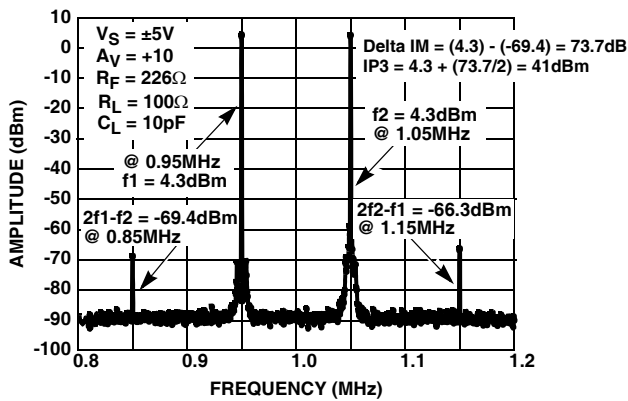

FIGURE 33. THIRD ORDER IMD INTERCEPT (IP3)

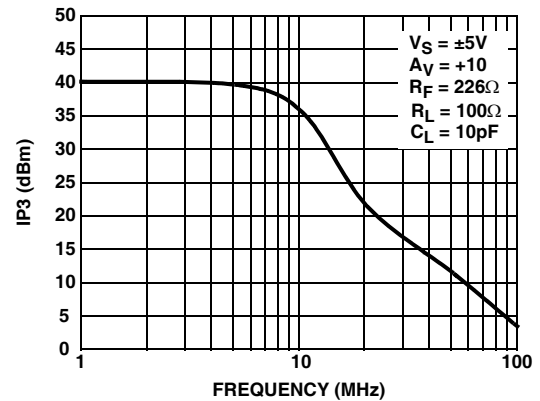

FIGURE 34. THIRD ORDER IMD INTERCEPT vs FREQUENCY

Typical Performance Curves (Continued)

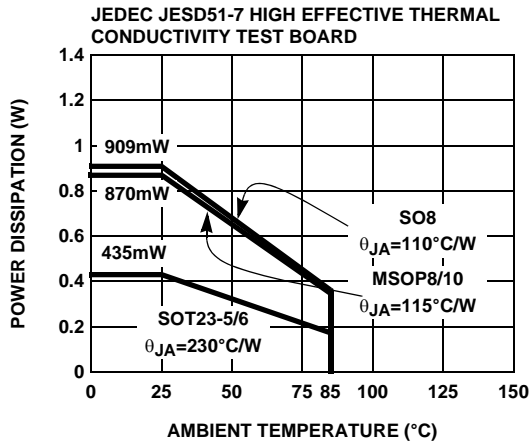

FIGURE 35. PACKAGE POWER DISSIPATION vs AMBIENT TEMPERATURE

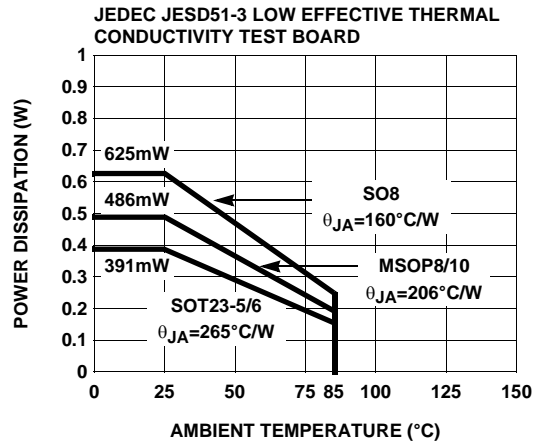

FIGURE 36. PACKAGE POWER DISSIPATION vs AMBIENT TEMPERATURE

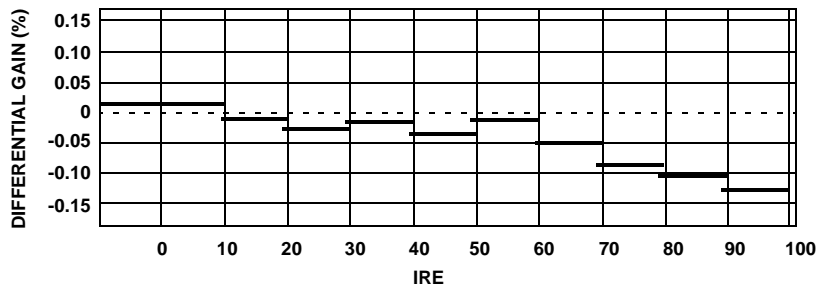

FIGURE 37. DIFFERENTIAL GAIN (%)

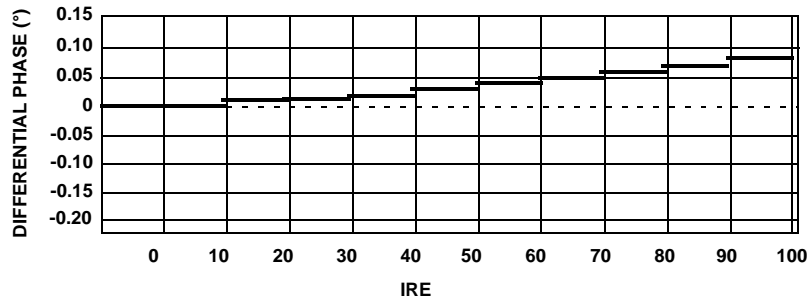

FIGURE 38. DIFFERENTIAL PHASE (°)

Product Description

The EL5134, EL5135, EL5234 and EL5235 are voltage feedback operational amplifiers designed for communication and imaging applications requiring very low voltage and current noise. They also feature low distortion while drawing moderately low supply current and is built on Intersil's proprietary high-speed complementary bipolar process. The EL5134, EL5135, EL5234 and EL5235 use a classical voltage-feedback topology which allows them to be used in a variety of applications where current-feedback amplifiers are

not appropriate because of restrictions placed upon the feedback element used with the amplifier.

Gain-Bandwidth Product and the -3dB Bandwidth

The EL5134, EL5135, EL5234 and EL5235 have a gain-bandwidth product of 1500MHz while using only 6.7mA of supply current per amplifier. For gains greater than 5 their closed-loop -3dB bandwidth is approximately equal to the gain-bandwidth product divided by the noise gain of the circuit. For gains of 5, higher-order poles in the amplifiers'

transfer function contribute to even higher closed loop bandwidths. For example, the EL5134, EL5135, EL5234 and EL5235 have a -3dB bandwidth of 650MHz at a gain of 5, dropping to 150MHz at a gain of 10. It is important to note that the EL5134, EL5135, EL5234 and EL5235 is designed so that this “extra” bandwidth in low-gain application does not come at the expense of stability. As seen in the typical performance curves, the EL5134, EL5135, EL5234 and EL5235 in a gain of only 5 exhibited 0.2dB of peaking with a 500Ω load.

Output Drive Capability

The EL5134, EL5135, EL5234 and EL5235 are designed to drive a low impedance load. They can easily drive 6V_{P-P} signal into a 500Ω load. This high output drive capability makes the EL5134, EL5135, EL5234 and EL5235 an ideal choice for RF, IF, and video applications. Furthermore, the EL5134, EL5135, EL5234 and EL5235 are current-limited at their outputs, allowing them to withstand momentary short to ground. However, the power dissipation with output-shortened cannot exceed the power dissipation capability of the package.

Driving Cables and Capacitive Loads

Although the EL5134, EL5135, EL5234 and EL5235 are designed to drive low impedance load, capacitive loads will decrease the amplifiers’ phase margin. As shown in the performance curves, capacitive load can result in peaking, overshoot and possible oscillation. For optimum AC performance, capacitive loads should be reduced as much as possible or isolated with a series resistor between 5Ω to 20Ω. When driving coaxial cables, double termination is always recommended for reflection-free performance. When properly terminated, the capacitance of the coaxial cable will not add to the capacitive load seen by the amplifier.

Disable/Power-Down

The EL5134 and EL5234 amplifiers can be disabled placing their outputs in a high impedance state. When disabled, each amplifier current is reduced to 12uA. The EL5134 and EL5234 are disabled when their \overline{CE} pins are pulled up to within 1V of the power supply. Similarly, the amplifiers are enabled by floating or pulling its \overline{CE} pin to at least 3V below the positive supply. For +/-5V supply, this means that EL5134 and EL5234 amplifiers will be enabled when \overline{CE} is 2V or less, and disabled when \overline{CE} is above 4V. Although the logic levels are not standard TTL, this choice of logic voltages allows the EL5134 and EL5234 to be enabled by typing \overline{CE} to ground, even in 5V single supply applications. The \overline{CE} pin can be driven from CMOS outputs.

Supply Voltage Range and Single-Supply Operation

The EL5134, EL5135, EL5234 and EL5235 have been designed to operate with supply voltages having a span of greater than 5V and less than 12V. In practical terms, this means that they will operate on dual supplies ranging from

±2.5V to ±6V. With single-supply, the EL5134, EL5135, EL5234 and EL5235 will operate from 5V to 12V. To prevent internal circuit latch-up, the slew rate between the negative and positive supplies must be less than 1V/nS.

As supply voltages continue to decrease, it becomes necessary to provide input and output voltage ranges that can get as close as possible to the supply voltages. The EL5134, EL5135, EL5234 and EL5235 have an input range which extends to within 2V of either supply. So, for example, on ±5V supplies, the EL5134, EL5135, EL5234 and EL5235 have an input range which spans ±3V. The output range of the EL5134, EL5135, EL5234 and EL5235 is also quite large, extending to within 2V of the supply rail. On a ±5V supply, the output is therefore capable of swinging from -3.1V to +3.1V. Single-supply output range is larger because of the increased negative swing due to the external pull-down resistor to ground.

Power Dissipation

With the wide power supply range and large output drive capability of the EL5134, EL5135, EL5234 and EL5235, it is possible to exceed the 150°C maximum junction temperatures under certain load and power-supply conditions. It is therefore important to calculate the maximum junction temperature (T_{JMAX}) for all applications to determine if power supply voltages, load conditions, or package type need to be modified for the EL5134, EL5135, EL5234 and EL5235 to remain in the safe operating area. These parameters are related as follows:

$$T_{JMAX} = T_{MAX} + (\theta_{JA} \times PD_{MAXTOTAL})$$

where:

- $PD_{MAXTOTAL}$ is the sum of the maximum power dissipation of each amplifier in the package (PD_{MAX})
- PD_{MAX} for each amplifier can be calculated as follows:

$$PD_{MAX} = 2 \times V_S \times I_{SMAX} + (V_S - V_{OUTMAX}) \times \frac{V_{OUTMAX}}{R_L}$$

where:

- T_{MAX} = Maximum ambient temperature
- θ_{JA} = Thermal resistance of the package
- PD_{MAX} = Maximum power dissipation of 1 amplifier
- V_S = Supply voltage
- I_{SMAX} = Maximum supply current of 1 amplifier
- V_{OUTMAX} = Maximum output voltage swing of the application
- R_L = Load resistance

Power Supply Bypassing And Printed Circuit Board Layout

As with any high frequency devices, good printed circuit board layout is essential for optimum performance. Ground

plane construction is highly recommended. Pin lengths should be kept as short as possible. The power supply pins must be closely bypassed to reduce the risk of oscillation. The combination of a 4.7 μ F tantalum capacitor in parallel with 0.1 μ F ceramic capacitor has been proven to work well when placed at each supply pin. For single supply operation, where pin 4 (V_{S-}) is connected to the ground plane, a single 4.7 μ F tantalum capacitor in parallel with a 0.1 μ F ceramic capacitor across pin 8 (V_{S+}).

For good AC performance, parasitic capacitance should be kept to a minimum. Ground plane construction again should be used. Small chip resistors are recommended to minimize series inductance. Use of sockets should be avoided since they add parasitic inductance and capacitance which will result in additional peaking and overshoot.

Small Outline Package Family (SO)

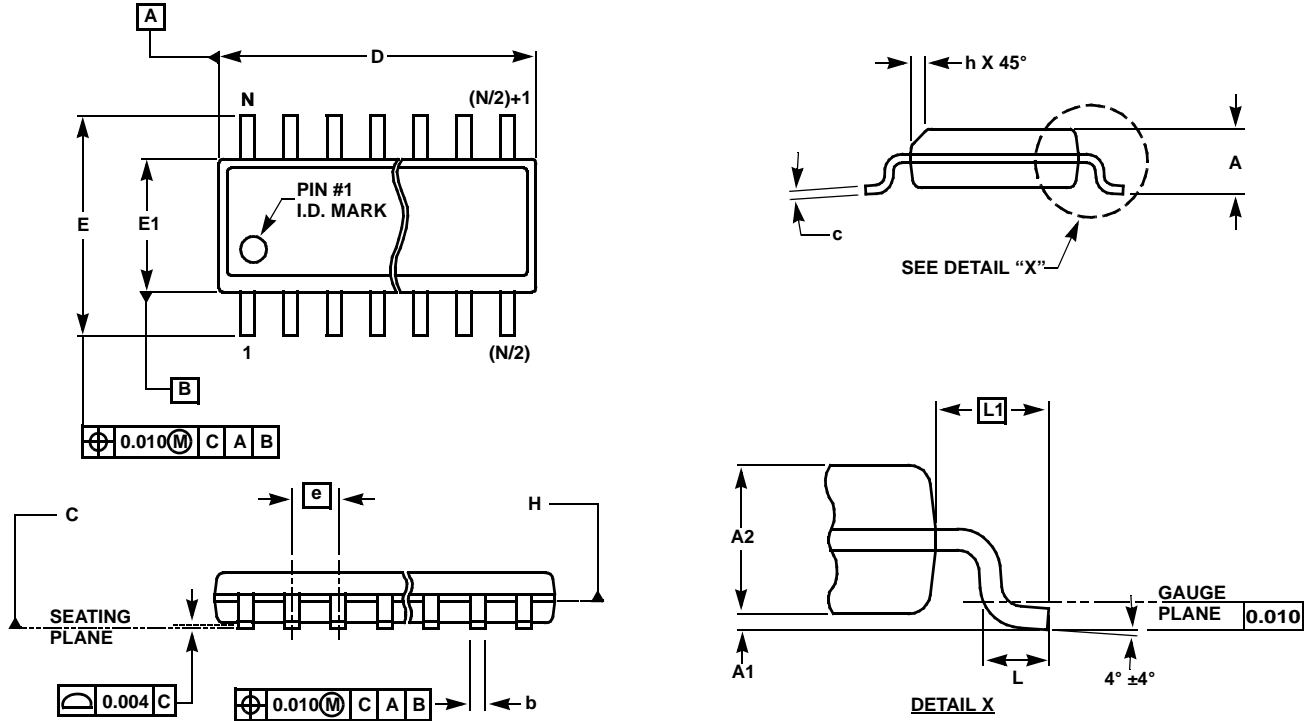

MDP0027

SMALL OUTLINE PACKAGE FAMILY (SO)

SYMBOL	INCHES							TOLERANCE	NOTES
	SO-8	SO-14	SO16 (0.150")	SO16 (0.300") (SOL-16)	SO20 (SOL-20)	SO24 (SOL-24)	SO28 (SOL-28)		
A	0.068	0.068	0.068	0.104	0.104	0.104	0.104	MAX	-
A1	0.006	0.006	0.006	0.007	0.007	0.007	0.007	±0.003	-
A2	0.057	0.057	0.057	0.092	0.092	0.092	0.092	±0.002	-
b	0.017	0.017	0.017	0.017	0.017	0.017	0.017	±0.003	-
c	0.009	0.009	0.009	0.011	0.011	0.011	0.011	±0.001	-
D	0.193	0.341	0.390	0.406	0.504	0.606	0.704	±0.004	1, 3
E	0.236	0.236	0.236	0.406	0.406	0.406	0.406	±0.008	-
E1	0.154	0.154	0.154	0.295	0.295	0.295	0.295	±0.004	2, 3
e	0.050	0.050	0.050	0.050	0.050	0.050	0.050	Basic	-
L	0.025	0.025	0.025	0.030	0.030	0.030	0.030	±0.009	-
L1	0.041	0.041	0.041	0.056	0.056	0.056	0.056	Basic	-
h	0.013	0.013	0.013	0.020	0.020	0.020	0.020	Reference	-
N	8	14	16	16	20	24	28	Reference	-

Rev. M 2/07

NOTES:

1. Plastic or metal protrusions of 0.006" maximum per side are not included.
2. Plastic interlead protrusions of 0.010" maximum per side are not included.
3. Dimensions "D" and "E1" are measured at Datum Plane "H".
4. Dimensioning and tolerancing per ASME Y14.5M-1994

SOT-23 Package Family

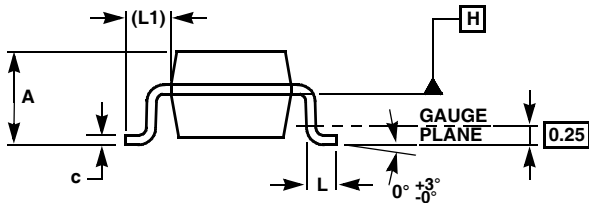
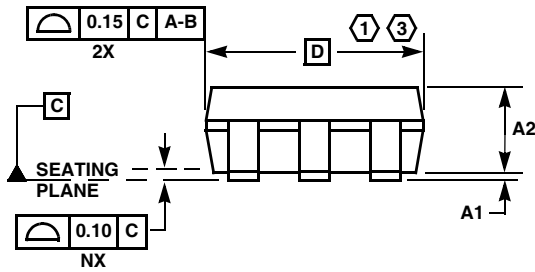
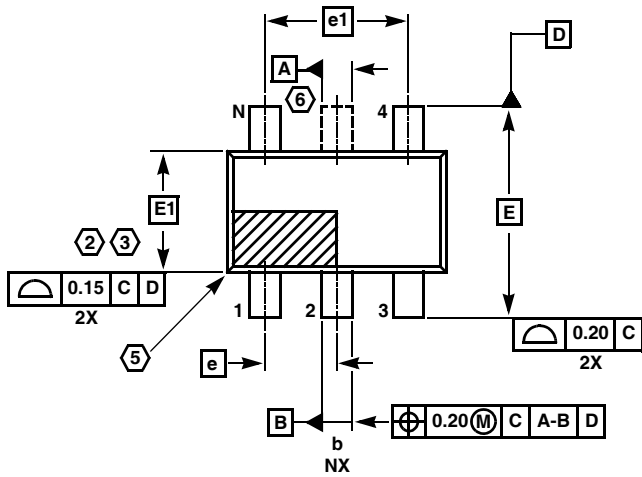

MDP0038

SOT-23 PACKAGE FAMILY

SYMBOL	MILLIMETERS		TOLERANCE
	SOT23-5	SOT23-6	
A	1.45	1.45	MAX
A1	0.10	0.10	±0.05
A2	1.14	1.14	±0.15
b	0.40	0.40	±0.05
c	0.14	0.14	±0.06
D	2.90	2.90	Basic
E	2.80	2.80	Basic
E1	1.60	1.60	Basic
e	0.95	0.95	Basic
e1	1.90	1.90	Basic
L	0.45	0.45	±0.10
L1	0.60	0.60	Reference
N	5	6	Reference

Rev. F 2/07

NOTES:

1. Plastic or metal protrusions of 0.25mm maximum per side are not included.
2. Plastic interlead protrusions of 0.25mm maximum per side are not included.
3. This dimension is measured at Datum Plane "H".
4. Dimensioning and tolerancing per ASME Y14.5M-1994.
5. Index area - Pin #1 I.D. will be located within the indicated zone (SOT23-6 only).
6. SOT23-5 version has no center lead (shown as a dashed line).

Mini SO Package Family (MSOP)

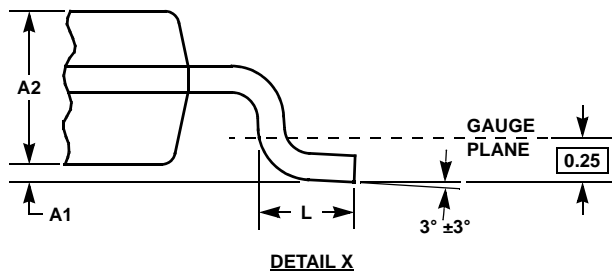
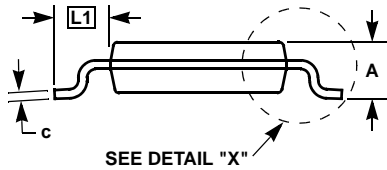
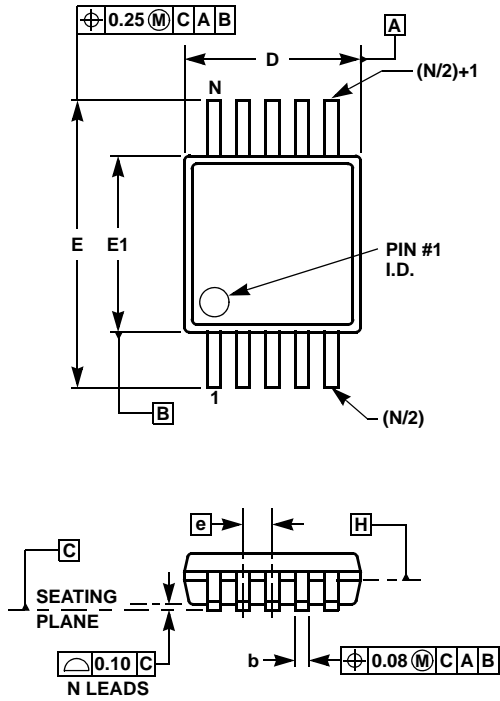

MDP0043
MINI SO PACKAGE FAMILY

SYMBOL	MILLIMETERS		TOLERANCE	NOTES
	MSOP8	MSOP10		
A	1.10	1.10	Max.	-
A1	0.10	0.10	±0.05	-
A2	0.86	0.86	±0.09	-
b	0.33	0.23	+0.07/-0.08	-
c	0.18	0.18	±0.05	-
D	3.00	3.00	±0.10	1, 3
E	4.90	4.90	±0.15	-
E1	3.00	3.00	±0.10	2, 3
e	0.65	0.50	Basic	-
L	0.55	0.55	±0.15	-
L1	0.95	0.95	Basic	-
N	8	10	Reference	-

Rev. D 2/07

NOTES:

1. Plastic or metal protrusions of 0.15mm maximum per side are not included.
2. Plastic interlead protrusions of 0.25mm maximum per side are not included.
3. Dimensions "D" and "E1" are measured at Datum Plane "H".
4. Dimensioning and tolerancing per ASME Y14.5M-1994.

All Intersil U.S. products are manufactured, assembled and tested utilizing ISO9000 quality systems.
Intersil Corporation's quality certifications can be viewed at www.intersil.com/design/quality

Intersil products are sold by description only. Intersil Corporation reserves the right to make changes in circuit design, software and/or specifications at any time without notice. Accordingly, the reader is cautioned to verify that data sheets are current before placing orders. Information furnished by Intersil is believed to be accurate and reliable. However, no responsibility is assumed by Intersil or its subsidiaries for its use; nor for any infringements of patents or other rights of third parties which may result from its use. No license is granted by implication or otherwise under any patent or patent rights of Intersil or its subsidiaries.

For information regarding Intersil Corporation and its products, see www.intersil.com