

# NAIS

## 1 HORSE-POWER COMPACT POWER RELAYS

# JA-RELAYS

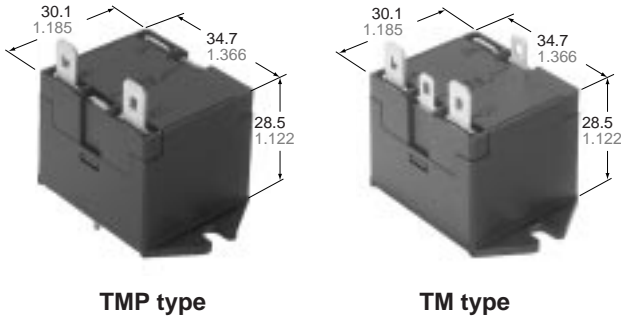

TMP type

TM type

mm inch

**UL File No.: E43028**

**CSA File No.: LR26550**

- High switching capacity — 55 A inrush, 15 A steady state inductive load (1 Form A)
- Particularly suitable for air conditioners, dish washers, microwave ovens, ranges, central cleaning systems, copiers, facsimiles, etc.
- Two types available
  - “TM” type for direct chassis mounting
  - “TMP” type for PC board mounting
- TV-rated types available
- TÜV also approved

## SPECIFICATIONS

### Contact

Arrangement	1 Form A, 1 Form B, 1 Form C		
Initial contact resistance, max. (By voltage drop 6 V DC 1 A)	30 mΩ		
Contact material	Silver alloy		
Rating (resistive load)	Maximum switching power	3,750 VA	
	Maximum switching voltage	250 V AC	
	Max. switching current	15A	
Expected life (min. operations)	Mechanical (at 180 cpm.)	5×10 <sup>6</sup>	
	Electrical (at 20 cpm.)	1 Form A (Inrush 55 A, Steady 15 A 250 VAC cosφ = 0.7)	10 <sup>5</sup>
		1 Form B, 1 Form C (15 A 250 VAC, cosφ = 1)	5×10 <sup>5</sup>

### Coil

Nominal operating power	DC type	1.2 W
	AC type	1.4 VA (50 Hz)/1.3 VA (60 Hz)
Minimum operating power	DC type	0.77 W
	AC type	0.90 VA (50 Hz)/0.84 VA (60 Hz)

### Remarks

- \*1 Measurement at same location as “Initial breakdown voltage” section
- \*2 Detection current: 10mA
- \*3 Wave is standard shock voltage of ±1.2 × 50μs according to JEC-212-1981
- \*4 Excluding contact bounce time
- \*5 For the AC coil types, the operate/release time will differ depending on the phase.
- \*6 Half-wave pulse of sine wave: 11ms; detection time: 10μs
- \*7 Half-wave pulse of sine wave: 6ms
- \*8 Detection time: 10μs
- \*9 Refer to 6. Usage, transport and storage conditions NOTES (Page 8)

### Characteristics

Maximum operating speed	20 cpm.	
Initial insulation resistance*1	Min. 100 MΩ at 500 V DC	
Initial break-down voltage*2	Between open contacts	1,500 Vrms
	Between contacts and coil	2,000 Vrms
Surge voltage between contacts and coil*3	Min. 5,000 V	
Operate time*4 (at 20°C) (at nominal voltage)	Approx. 10 ms*5	
Release time(without diode)*4 (at 20°C) (at nominal voltage)	Approx. 2 ms*5	
Temperature rise (at 50°C) (resistive)	Max. 70°C	
Shock resistance	Functional*6	98 m/s <sup>2</sup> {10 G}
	Destructive*7	980 m/s <sup>2</sup> {100 G}
Vibration resistance	Functional*8	88.2 m/s <sup>2</sup> {9 G}, 10 to 55 Hz at double amplitude of 1.5 mm
	Destructive	117.6 m/s <sup>2</sup> {12 G}, 10 to 55 Hz at double amplitude of 2.0 mm
Conditions for operation, transport and storage*9 (Not freezing and condensing at low temperature)	Ambient temp.	-10°C to +50°C +14°F to +122°F
	Humidity	5 to 85%R.H.
Unit weight	44 g 1.55 oz	

## TYPICAL APPLICATIONS

Air conditioners, microwave ovens, load management equipment, copiers, process control equipment

## ORDERING INFORMATION

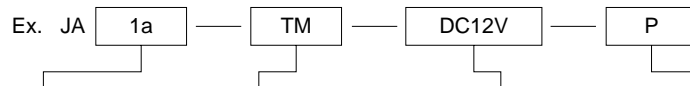

Contact arrangement	Mounting classification	Coil voltage	Classification
1c: 1 Form C 1a: 1 Form A 1b: 1 Form B	TM: Solder Terminal TMP: Solder Terminal and PCB Terminal	DC 6, 12, 24 V AC 6, 12, 24, 115 V	Nil: Standard type P: Up-graded contact rating type (See next page)

- (Notes) 1. For UL/CSA recognized types, add suffix UL/CSA.  
2. Standard packing Carton: 20 pcs.; Case: 200 pcs.

# COIL DATA

## DC Type at 20°C 68°F

Nominal voltage	Pick-up voltage (max.)	Drop-out* voltage (min.)	Coil resistance, W (±10%)	Nominal operating current, mA (±10%)	Nominal operating power	Maximum allowable voltage (at 60°C)
6 V DC	4.8 V DC	0.6 (0.3*) V DC	30	200	1.2 W	6.6 V DC
12	9.6	1.2 (0.6*)	120	100	1.2	13.2
24	19.2	2.4 (1.2*)	480	50	1.2	26.4

## AC Type at 20°C 68°F

Nominal voltage	Pick-up voltage (max.)	Drop-out* voltage (min.)	Coil resistance, W (±10%)	Nominal operating current, mA (±10%)		Nominal operating power		Maximum allowable voltage (at 60°C)
				50 Hz	60 Hz	50 Hz	60 Hz	
6 V AC	4.8 V AC	1.8 V AC	—	50 Hz	60 Hz	50 Hz	60 Hz	6.6 V DC
				233	217	1.4 VA	1.3 VA	
12	9.6	3.6	—	117	108	1.4 VA	1.3 VA	13.2
24	19.2	7.2	—	58	54	1.4 VA	1.3 VA	26.4
115	92	34.5	—	12	11	1.4 VA	1.3 VA	126.5

\* Drop-out voltage for 1 Form B type is 5% of nominal voltage.

### NOTES

- The range of coil current for AC relay is ±15% (60 Hz). For DC relay it is ±10% at 20°C.
- The JA relay will operate in a range from 80% to 110% of the nominal coil voltage. It is however, recommended that the relay be used in the range of 85% to 110% of the nominal coil voltage, with the temporary voltage variation taken into consideration.
- When the operating voltage of AC relays drops below 80% of the nominal coil voltage. The relay will generate a considerable amount of heat which is not recommended for maximum efficiency.
- The coil resistance of DC types is the measured value of the coil at a temperature of 20°C (68°F). If the coil temperature changes by ±1°C. The measured value of the coil resistance should be increased or decreased by 0.4%.

## ADDITIONAL SERIES

1. Following up-graded contact rating types recognized by UL are available. (For use in office appliances)

Contact arrangement	Suffix	P (Ex. JA 1a-TM DC12V-P)
1 Form C		25 A 250 V AC, 1 HP 125, 250 V AC
1 Form A		25 A 250 V AC, 1 HP 125, 250 V AC
1 Form B		25 A 250 V AC, 1 HP 125, 250 V AC

2. TV-Rated Series

Contact arrangement	Suffix	UL	CSA
		TV	TV
1 Form A		TV-5	TV-5

## DIMENSIONS

TM

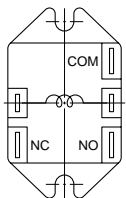
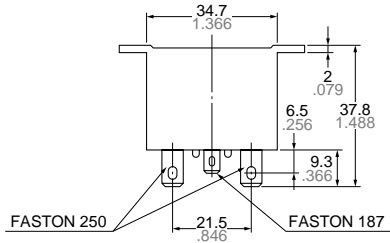
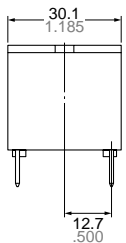
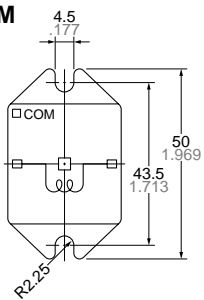

### Schematic (Bottom view)

mm inch

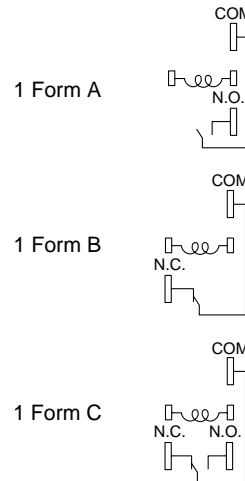

Terminals—.187" quick connect terminals for coil and .250" for contacts

### Mounting hole location

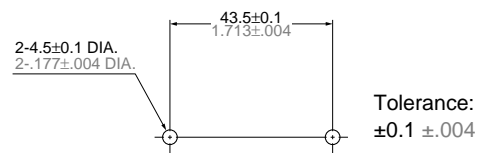

### Remarks

Above dimensions are for 1 Form C type.  
For 1 Form A type, NC terminal is removed  
For 1 Form B type, NO terminal is removed.

General tolerance: ±0.3 ±.012

TMP

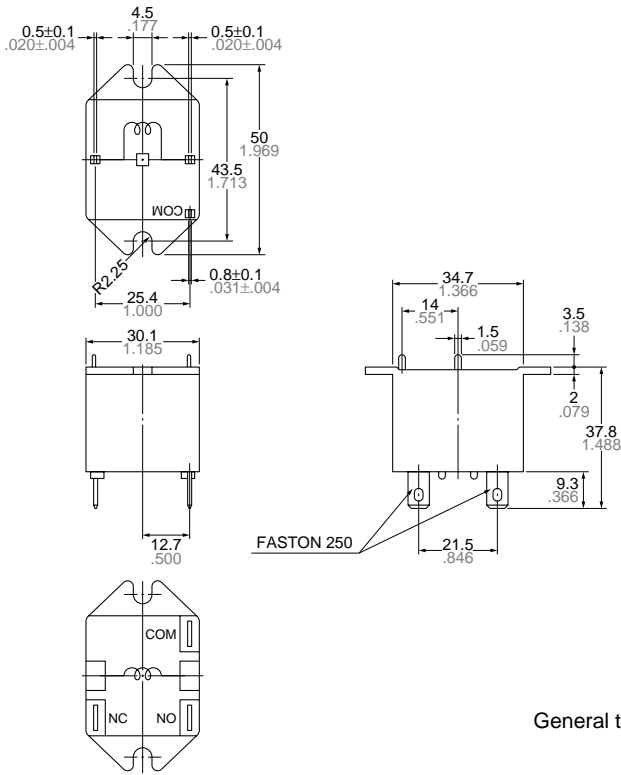

Schematic

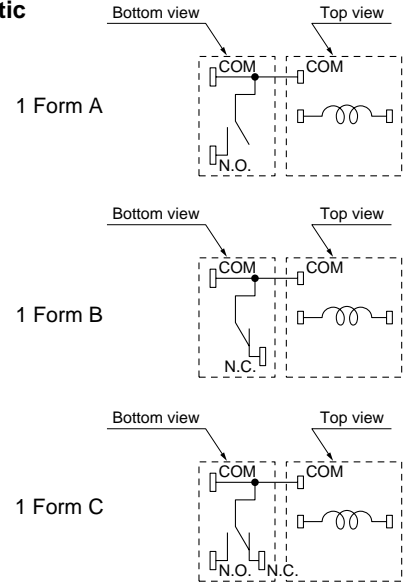

Terminals—PC board terminals for coils and .250" quick connect terminals for contacts

Mounting hole location

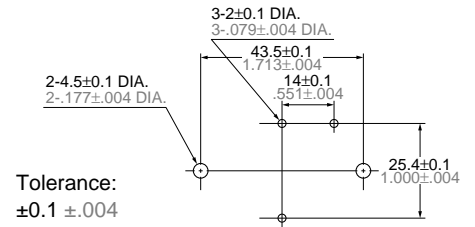

General tolerance: ±0.3 ±.012

Remarks

Above dimensions are for 1 Form C type.  
For 1 Form A type, NC terminal is removed  
For 1 Form B type, NO terminal is removed.

REFERENCE DATA

1. Maximum value for switching capacity (Common for 1a, 2b, and 1c)

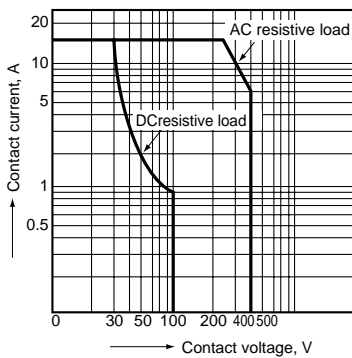

2. Life curve (Common for 1a, 1b, and 1c)

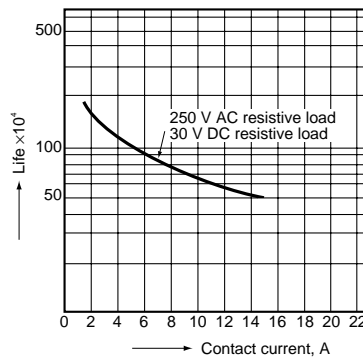

3.-(1) Coil temperature rise (1a-AC type)

Point measured: Inside the coil  
Ambient temperature: 25°C 77°F

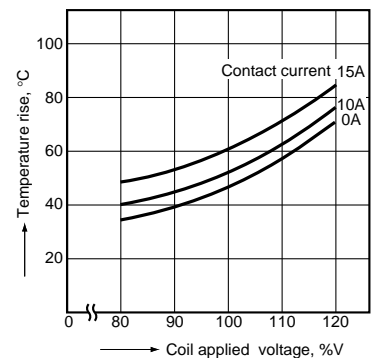

3.-(2) Coil temperature rise (1a-DC type)

Point measured: Inside the coil  
Ambient temperature: 25°C 77°F

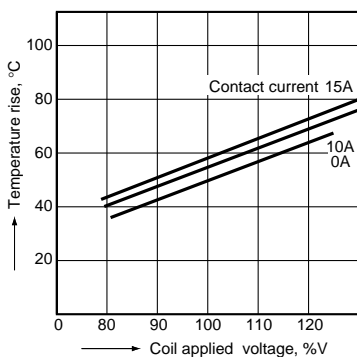

4.-(1) Operate time (1a-AC type)

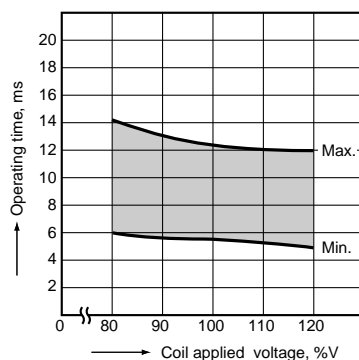

4.-(2) Operate time (1a-DC type)

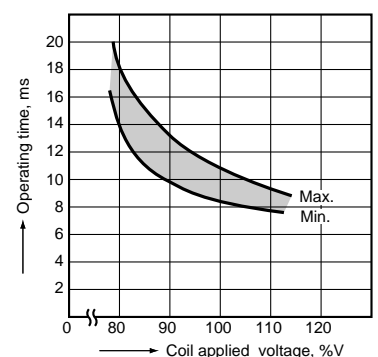

5.-(1) Release time (1a-AC type)

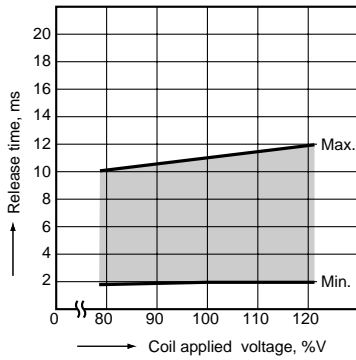

5.-(2) Release time (1a-DC type)

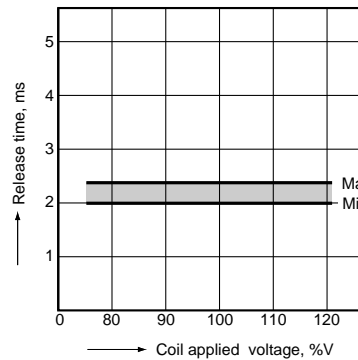

6.-(1) Electrical life (15 A 250 V AC resistive)

1. Tested sample: JA1c-TMP-AC115V
2. Load: 15 A 250 V AC resistive load
3. Cycle rate: 20 cpm.
4. Circuit:

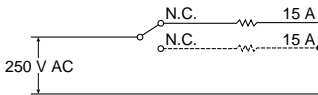

TEST RESULT:

1. Pick-up and drop-out voltage

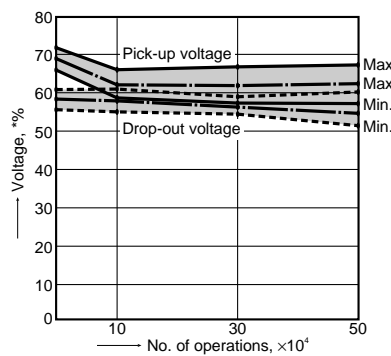

\* This shows percent rate against nominal coil voltage.

2. Contact resistance

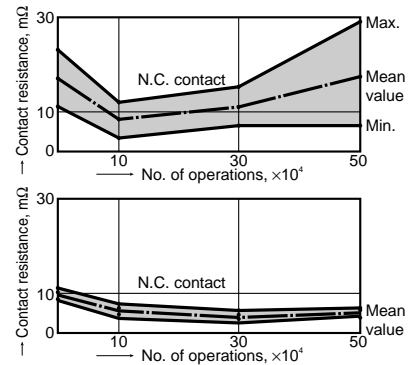

3. No abnormality was observed in either insulation resistance or breakdown voltage.

6.-(2) Electrical life (15 A 250 V AC Motor simulated load)

1. Tested sample: JA1a-TM-DC12V
2. Load: 250 V AC inductive load ( $\cos\phi = 0.7$ )  
15 A steady and 55 A (0.3s\*) inrush current
3. Cycle rate: 20 cpm.
4. Circuit:

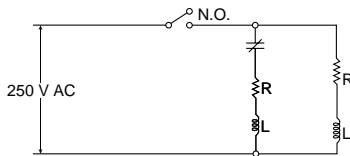

TEST RESULT:

1. Pick-up and drop-out voltage

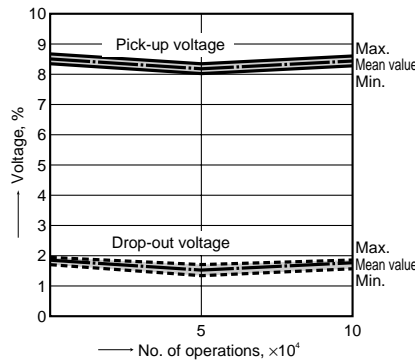

2. Contact resistance

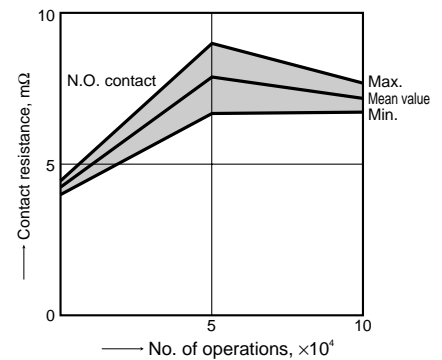

3. No abnormality was observed in either insulation resistance or breakdown voltage.

For Cautions for Use