

Ex Polyester enclosures



- Glass fibre reinforced polyester enclosure system for application in all Ex areas
- Empty enclosures for individual fittings and Ex e / Ex ia junction boxes
- Optional version with window
- Temperature classes T6 / T5 / T4



Technical Data

Explosion protection

Ex II 2 G

Ex II 2 D

Ex e II T6 (increased safety)

Ex ia IIC T6 (intrinsic safety)

Ex e(ia) IIC T6 (mixed fitting)

Certificates

IECEx PTB 08.0003U, PTB 01 ATEX 1061U, Gost R, INMETRO MC AEX-8296-U, Gost K

IECEx PTB 08.0004, PTB 00 ATEX 1002, Gost R, INMETRO MC AEX-8503-X, Gost K

S-XPL/12.0778

Material

glass fibre reinforced duroplastic polyester, graphite added

Colour

RAL 9011, graphite black

Ingress protection

IP 66 to EN 60529

Impact resistance

7 Joule to EN 60079-0

Flammability

self-extinguishing, UL 94 V-0

Surface resistance

<10⁹ Ohm to IEC 60093

Toxicity

halogen-free

Temperature range

-20°C to +40°C (corresponds T6 = 85°C max. surface temperature)

-20°C to +55°C (corresponds T5 = 100°C max. surface temperature)

-20°C to +90°C (corresponds T4 = 135°C max. surface temperature)

to -55°C with special marking on request

Included in delivery

Empty enclosure:

Enclosure system with silicone seal

Junction box:

Enclosure system - depending on version

with silicone seal, DIN rails, internal

earthing connection, terminals, continuity

plate, manufacturing, cable glands

Product range

Order No.			
Ex e	Ex ia	empty enclosures	
06.08 08 06	16.08 08 06	26.08 08 06	75 x 80 x 56
06.08 08 08	16.08 08 08	26.08 08 08	75 x 80 x 75
06.08 11 06	16.08 11 06	26.08 11 06	75 x 110 x 56
06.08 11 08	16.08 11 08	26.08 11 08	75 x 110 x 75
06.08 16 06	16.08 16 06	26.08 16 06	75 x 160 x 56
06.08 16 08	16.08 16 08	26.08 16 08	75 x 160 x 75
06.08 19 06	16.08 19 06	26.08 19 06	75 x 190 x 56
06.08 19 08	16.08 19 08	26.08 19 08	75 x 190 x 75
06.08 23 06	16.08 23 06	26.08 23 06	75 x 230 x 56
06.08 23 08	16.08 23 08	26.08 23 08	75 x 230 x 75
06.12 12 09	16.12 12 09	26.12 12 09	120 x 122 x 91
06.12 22 09	16.12 22 09	26.12 22 09	120 x 220 x 91
06.16 16 09	16.16 16 09	26.16 16 09	160 x 160 x 91
06.16 26 09	16.16 26 09	26.16 26 09	160 x 260 x 91
06.16 36 09	16.16 36 09	26.16 36 09	160 x 360 x 91
06.16 56 09	16.16 56 09	26.16 56 09	160 x 560 x 91
06.25 26 12	16.25 26 12	26.25 26 12	250 x 255 x 121
06.25 26 16	16.25 26 16	26.25 26 16	250 x 255 x 161
06.25 40 12	16.25 40 12	26.25 40 12	250 x 400 x 121
06.25 40 16	16.25 40 16	26.25 40 16	250 x 400 x 161
06.25 60 12	16.25 60 12	26.25 60 12	250 x 600 x 121
06.36 36 09	16.36 36 09	26.36 36 09	360 x 360 x 91
06.41 40 12	16.41 40 12	26.41 40 12	405 x 400 x 121
06.41 40 20	16.41 40 20	26.41 40 20	405 x 400 x 201

Accessories

Type	DIN rail* TS 15 TS 35	PE bar	PE bus bar	allen lid screws	sealable lid screws	external mounting brackets	external hinge	continuity plate	mounting plate
06/16/26.08 08 06	•		•	•	•	•		•	2,0
06/16/26.08 08 08	•		•	•	•	•		•	2,0
06/16/26.08 11 06	•		•	•	•	•		•	2,0
06/16/26.08 11 08	•		•	•	•	•		•	2,0
06/16/26.08 16 06	•		•	•	•	•		•	2,0
06/16/26.08 16 08	•		•	•	•	•		•	2,0
06/16/26.08 19 06	•		•	•	•	•		•	2,0
06/16/26.08 19 08	•	•	•	•	•	•		•	2,0
06/16/26.08 23 06	•		•	•	•	•		•	-
06/16/26.08 23 08	•		•	•	•	•		•	-
06/16/26.12 12 09		•	•	•	•	•	•	•	1,5
06/16/26.12 22 09		•	•	•	•	•	•	•	1,5
06/16/26.16 16 09	•	•		•	•	•	•	•	1,5
06/16/26.16 26 09	•	•		•	•	•	•	•	1,5
06/16/26.16 36 09	•	•		•	•	•	•	•	1,5
06/16/26.16 56 09	•	•		•	•	•	•	•	2,0
06/16/26.25 26 12	•	•		•	•	•	•	•	2,0
06/16/26.25 26 16	•	•		•	•	•	•	•	2,0
06/16/26.25 40 12	•	•		•	•	•	•	•	2,0
06/16/26.25 40 16	•	•		•	•	•	•	•	2,0
06/16/26.25 60 12	•	•		•	•	•	•	•	2,0
06/16/26.36 36 09	•	•		•	•	•	•	•	2,0
06/16/26.41 40 12	•	•		•	•	•	•	•	2,0
06/16/26.41 40 20	•	•		•	•	•	•	•	2,0

* TS 32 on request

External mounting brackets (4 pcs.) for xx.08 08 06 bis xx.08 23 08	10.03 11 01
External mounting brackets (4 pcs.) from xx.12 12 09	10.03 11 02
External hinge (pair) from xx.12 12 09	10.02 70 01

For further technical informations see page 128 ff

Ex Polyester enclosures



Terminal mounting

Make	Phoenix															Bartec				
DIN rail TS 15				X	X			X												
DIN rail TS 32																				
DIN rail TS 35	X	X	X			X	X		X	X	X	X	X	X	X					
Voltage (V)	352	550	690	275	420	690	690	275	690	690	690	690	880	1100	1100	380	380			
Current (A)	17	22	23	22,5	27	32,5	43,5	37	57	74	118,5	137	216	256	350					
Nominal cross section (mm ²)	1,5	2,5	2,5	2,5	4	4	6	6	10	16	35	50	95	150	240	2,5	2,5			
Terminal width (mm)	4,2	5,2	5,2	5,2	6,2	6,2	8,2	8,2	10,2	12,2	16	20	25	31	36	30	30			
Terminal Type																				
Enclosure Type	UK 1,5 N	UK 2,5 N	UK 3 N	MBK 3/E-Z	MXK 4	UK 5 N	UK 6 N	MBK 6/E	UK 10 N	UK 16 N	UK 35	UKH 50	UKH 95	UKH 150	UKH 240	Ex-Mini-Klemmen	Ex-Mini-Klemmen blau	Mantelklemme (2 x 4 mm ² , 3 x 2,5 mm ² pro Klemme)	Mantelklemme (2 x 6 mm ² , 3 x 4 mm ² , 4 x 2,5 mm ² pro Klemme)	PE bar 1,5 to 6 mm ²
06/16./26.08 08 06				7												3	3	2		
06/16./26.08 08 08				8	7													2		
06/16./26.08 11 06				13														4		
06/16./26.08 11 08				14	11													4		
06/16./26.08 16 06				23														4		
06/16./26.08 16 08				23	20													4		
06/16./26.08 19 06				28														4		
06/16./26.08 19 08				29	24													4		
06/16./26.08 23 06				36														4		
06/16./26.08 23 08				37	31													4		
06/16./26.12 12 09	19	15	15	15	13	13	10	10	8	6									2	
06/16./26.12 22 09	42	34	34	34	29	29	21	21	17	14									4	
06/16./26.16 16 09	28	23	23	23	19	19	14	14	11	9	7									10
06/16./26.16 26 09	52	42	42	42	35	35	26	26	21	18	14									22
06/16./26.16 36 09	76	61	61	61	51	51	39	39	31	26	21									32
06/16./26.16 56 09	123	100	100	100	83	83	63	63	50	42	34									52
06/16./26.25 26 12	102	82	82	82	68	68	52	52	21	17	14	10								22
06/16./26.25 26 16	102	82	82	82	68	68	52	52	21	17	14	10								22
06/16./26.25 40 12	170	138	138	138	116	116	86	86	35	29	23	18								38
06/16./26.25 40 16	170	138	138	138	116	116	86	86	35	29	23	18								38
06/16./26.25 60 12	266	214	214	214	180	180	136	136	54	45	36	28								58
06/16./26.36 36 09	228	183	183	183	153	153	78	78	62	52	42									32
06/16./26.41 40 12	255	207	207	207	174	174	129	129	70	58	23	18								38
06/16./26.41 40 20	255	207	207	207	174	174	129	129	70	58	23	18	14	11						38

PE terminal as required

Ex Polyester enclosures



Terminal mounting

Make	Weidmüller																										
DIN rail TS 15	X	X	X	X																							
DIN rail TS 32							X	X		X		X		X			X										
DIN rail TS 35					X	X			X		X		X		X	X		X	X	X	X	X					
Voltage (V)	275	176	176	275	440	550	550	550	690	550	550	550	690	690	690	550	690	690	690	880	1100	1100					
Current (A)	14	10	15	21	21	21	21	28	28	36	36	50	50	66	66	109	109	126	167	202	243	234	300				
Nominal cross section (mm²)	1,5	1,5	2,5	4	2,5	2,5	2,5	4	4	6	6	10	10	16	16	35	35	50	70	95	120	150	240				
Terminal width (mm)	3,5	5,1	5,1	6,1	5,1	5,1	6	6,5	6,1	8	7,9	10	9,9	12	11,9	16	18	18,5	20,5	27	27	32	36				
Terminal Type																											
Enclosure Type	WDU 1,5 / R 3,5/E	AKZ 1,5	AKZ 2,5	AKZ 4	WDU 2,5 N	WDU 2,5	SAK 2,5	SAK 4	WDU 4	SAK 6N	WDU 6	SAK 10	WDU 10	SAK 16	WDU 16	WDU 35	SAK 35	WDU 50N	WDU 70N	WDU 70/95	WDU 95N/120N	WDU 120/150	WDU 240	Mantelklemme (2 x 4 mm², 3 x 2,5 mm² pro Klemme)	Mantelklemme (2 x 6 mm², 3 x 4 mm², 4 x 2,5 mm² pro Klemme)	PE bar 1,5 to 6 mm²	
06/16./26.08 08 06	11	4	4																						2		
06/16./26.08 08 08	11	4	4																						2		
06/16./26.08 11 06	19	11	11	9																					4		
06/16./26.08 11 08	19	11	11	9																					4		
06/16./26.08 16 06	33	21	20	17																					4		
06/16./26.08 16 08	33	21	20	17																					4		
06/16./26.08 19 06	42	26	26	21																					4		
06/16./26.08 19 08	42	26	26	21																					4		
06/16./26.08 23 06	53	34	34	29																					4		
06/16./26.08 23 08	53	34	34	29																					4		
06/16./26.12 12 09	13	12	10	13	13	11	11	11	11	8	8	6	6													2	
06/16./26.12 22 09	32	32	27	33	33	28	28	28	28	21	21	16	16													4	
06/16./26.16 16 09	20	20	17	21	21	18	18	18	13	13	11	11	9	9													10
06/16./26.16 26 09	40	39	33	41	41	34	34	34	26	26	21	21	17	17													22
06/16./26.16 36 09	59	59	49	60	60	50	50	50	38	38	30	30	25	25													32
06/16./26.16 56 09	98	98	82	102	102	85	85	85	63	63	51	51	42	42													52
06/16./26.25 26 12	76	76	64	78	78	64	64	64	50	50	20	20	16	16	12	11	10										22
06/16./26.25 26 16	76	76	64	78	78	64	64	64	50	50	20	20	16	16	12	11	10	10									22
06/16./26.25 40 12	132	132	110	136	136	114	114	114	86	86	34	34	29	29	21	19	18										38
06/16./26.25 40 16	132	132	110	136	136	114	114	114	86	86	34	34	29	29	21	19	18	17									38
06/16./26.25 60 12	212	210	176	216	216	180	180	180	136	136	54	54	45	45	34	30	28										58
06/16./26.36 36 09	177	177	147	183	183	153	153	153	72	72	60	60	50	50													32
06/16./26.41 40 12	198	198	165	204	204	171	171	171	129	129	68	68	58	58	21	19	18										38
06/16./26.41 40 20	198	198	165	204	204	171	171	171	129	129	68	68	58	58	21	19	18	17	12	12	10						38

PE terminal as required

Ex Polyester enclosures



Accessories / Execution

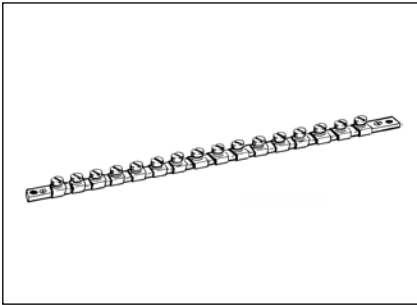

PE bar

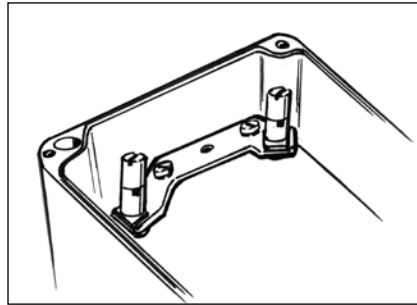

PE bus bar

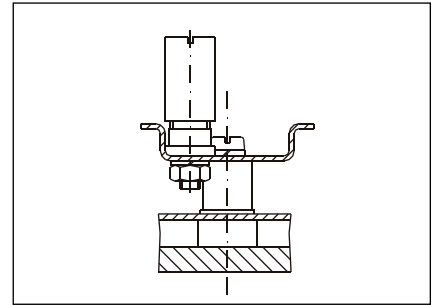

PE connection on DIN rail

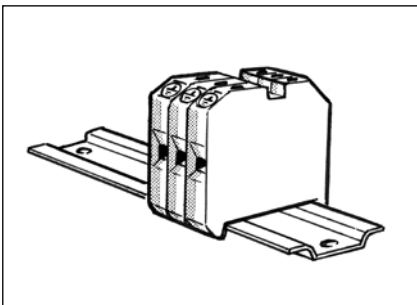

PE terminal block

Accessories

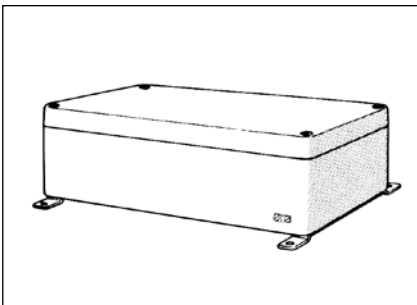

External mounting bracket (4 pieces) of stainless steel

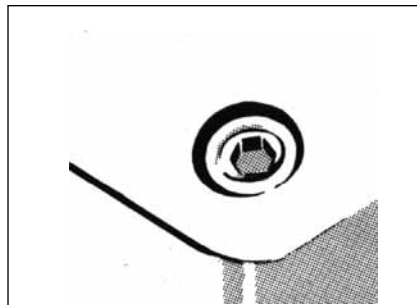

Allen lid screw, stainless steel

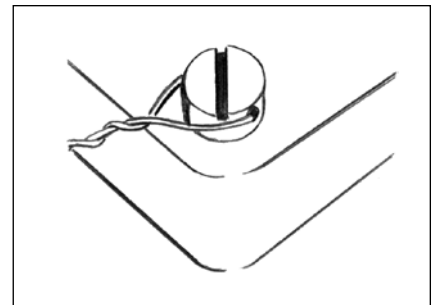

Sealable lid screw, corrosion-resistant

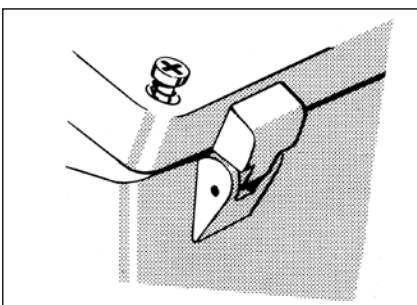

External hinge (pair), Alu diecast, swivel range 150°
Please specify mounting side!

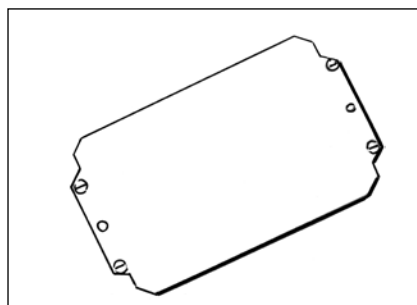

Mounting plate, sheet steel, galvanized

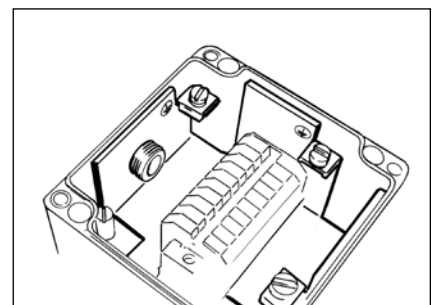

Continuity plate / angle, sheet steel, galvanized with throughhole, optional brass nickel plated with thread

Ex Polyester enclosures



Type: **Ex e 06.08 08 06**

Ex ia 16.08 08 06



26.08 08 06

ATEX

h x w x d 75 x 80 x 56 mm

286 g

l in mm	in mm	N	N							
TS 15										
63	38,5		•	•	•	•	•	•	•	•

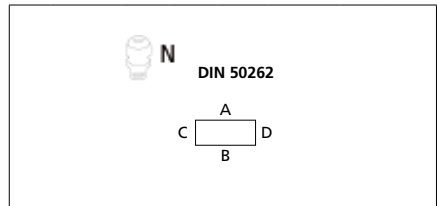

	1,5	2,5	4	6	10	16	25	35	50	70	95
	7	7									
UL N	1	1									
	6										
	10	27									
	16	9	18								
	20	3	10								
	25		5								
	35										
	50										
	63										
	80										
	100										
	125										
	160										
	200										
	225										
	250										
	315										
400											
500											

M		Side		PG		Side	
		A/B	C/D			A/B	C/D
12	17,25	6	3	7	17,25	6	3
16	25,30	2	1	9	21,85	4	1
20	27,60	2	1	11	25,30	2	1
25	37,95	1		13,5	27,60	2	1
32	48,30			16	31,05	2	1
40	60,95			21	37,95	1	
50	69,00			29	48,30		
63	74,75			36	60,95		
				42	69,00		
				48	74,75		

** Base: Terminal block Phoenix Contact, further see page 128 + 129

Type: **Ex e 06.08 08 08**

Ex ia 16.08 08 08



26.08 08 08

ATEX

h x w x d 75 x 80 x 75 mm

336 g

l in mm	in mm	N	N							
TS 15										
63	38,5		•	•	•	•	•	•	•	•

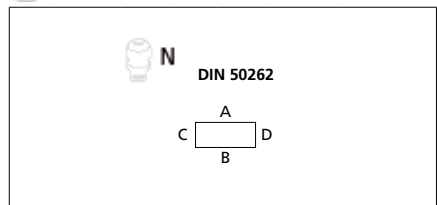

	1,5	2,5	4	6	10	16	25	35	50	70	95
	8	8	7								
UL N	1	1	1								
	6										
	10	32									
	16	11	21	84							
	20	4	12	24							
	25		6	13							
	35			4							
	50										
	63										
	80										
	100										
	125										
	160										
	200										
	225										
	250										
	315										
400											
500											

M		Side		PG		Side	
		A/B	C/D			A/B	C/D
12	17,25	9	5	7	17,25	9	5
16	25,30	5	2	9	21,85	6	3
20	27,60	4	2	11	25,30	4	2
25	37,95	1	1	13,5	27,60	4	2
32	48,30	1	1	16	31,05	3	1
40	60,95			21	37,95	1	1
50	69,00			29	48,30	1	
63	74,75			36	60,95		
				42	69,00		
				48	74,75		

** Base: Terminal block Phoenix Contact, further see page 128 + 129

Ex Polyester enclosures



Type: **Ex e 06.08 11 06**

Ex ia 16.08 11 06



26.08 11 06

ATEX

h x w x d 75 x 110 x 56 mm



351 g

l in mm	in mm	N	N						
TS 15									
98	68,5		•	•	•	•		•	•

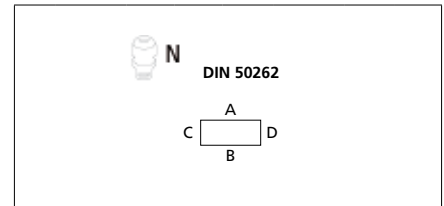

		1,5	2,5	4	6	10	16	25	35	50	70	95
	**	13	13									
	N	1	1									
	6											
	10	28										
	16	9	18									
	20	4	11									
	25		5									
	35											
	50											
	63											
	80											
	100											
	125											
	160											
	200											
	225											
	250											
	315											
400												
500												

M		Side		PG		Side	
		A/B	C/D			A/B	C/D
12	17,25	6	3	7	17,25	6	3
16	25,30	3	1	9	21,85	4	1
20	27,60	2	1	11	25,30	2	1
25	37,95	1		13,5	27,60	2	1
32	48,30			16	31,05	2	1
40	60,95			21	37,95	1	
50	69,00			29	48,30		
63	74,75			36	60,95		
				42	69,00		
				48	74,75		

** Base: Terminal block Phoenix Contact, further see page 128 + 129

Type: **Ex e 06.08 11 08**

Ex ia 16.08 11 08



26.08 11 08

ATEX

h x w x d 75 x 110 x 75 mm



403 g

l in mm	in mm	N	N						
TS 15									
98	68,5		•	•	•	•		•	•

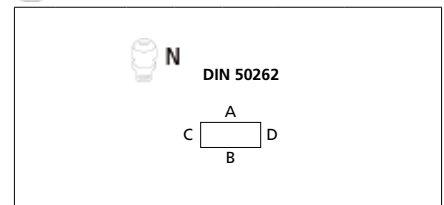

		1,5	2,5	4	6	10	16	25	35	50	70	95
	**	14	14	11								
	N	1	1	1								
	6											
	10	33										
	16	11	22	86								
	20	4	13	25								
	25		6	14								
	35			4								
	50											
	63											
	80											
	100											
	125											
	160											
	200											
	225											
	250											
	315											
400												
500												

M		Side		PG		Side	
		A/B	C/D			A/B	C/D
12	17,25	15	5	7	17,25	15	5
16	25,30	6	2	9	21,85	9	3
20	27,60	6	1	11	25,30	6	2
25	37,95	2	1	13,5	27,60	6	1
32	48,30	2	1	16	31,05	5	1
40	60,95			21	37,95	2	1
50	69,00			29	48,30	2	
63	74,75			36	60,95		
				42	69,00		
				48	74,75		

** Base: Terminal block Phoenix Contact, further see page 128 + 129

Ex Polyester enclosures













Type: **Ex e 06.08 16 06** **Ex ia 16.08 16 06**  **26.08 16 06**





ATEX

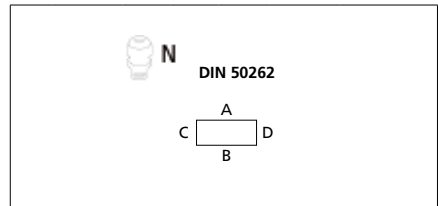

h x w x d 75 x 160 x 56 mm

 **461 g**

									
l in mm	in mm	N	N						
TS 15									
148	118,5		•	•	•	•	•	•	•



	1,5	2,5	4	6	10	16	25	35	50	70	95
 **	23	23									
 N	1	1									
 A	6										
	10	28									
	16	9	19								
	20	4	11								
	25		5								
	35										
	50										
	63										
	80										
	100										
	125										
	160										
	200										
	225										
	250										
	315										
400											
500											

M		Side		PG		Side	
		A/B	C/D			A/B	C/D
12	17,25	12	3	7	17,25	12	2
16	25,30	5	1	9	21,85	8	1
20	27,60	4	1	11	25,30	5	1
25	37,95	3		13,5	27,60	4	1
32	48,30			16	31,05	3	1
40	60,95			21	37,95	3	
50	69,00			29	48,30		
63	74,75			36	60,95		
				42	69,00		
				48	74,75		











** Base: Terminal block Phoenix Contact, further see page 128 + 129

Type: **Ex e 06.08 16 08** **Ex ia 16.08 16 08**  **26.08 16 08**





ATEX

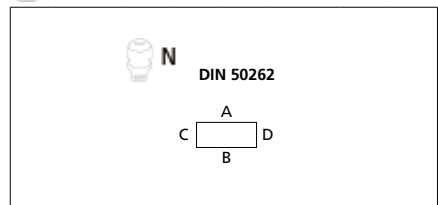

h x w x d 75 x 160 x 75 mm

 **542 g**

									
l in mm	in mm	N	N						
TS 15									
148	118,5		•	•	•	•	•	•	•



	1,5	2,5	4	6	10	16	25	35	50	70	95
 **	23	23	20								
 N	1	1	1								
 A	6										
	10	34									
	16	11	22	87							
	20	4	13	25							
	25		6	14							
	35			4							
	50										
	63										
	80										
	100										
	125										
	160										
	200										
	225										
	250										
	315										
400											
500											

M		Side		PG		Side	
		A/B	C/D			A/B	C/D
12	17,25	18	5	7	17,25	18	5
16	25,30	8	2	9	21,85	11	3
20	27,60	8	2	11	25,30	8	2
25	37,95	3	1	13,5	27,60	8	2
32	48,30	2	1	16	31,05	5	1
40	60,95			21	37,95	3	1
50	69,00			29	48,30	2	
63	74,75			36	60,95		
				42	69,00		
				48	74,75		

** Base: Terminal block Phoenix Contact, further see page 128 + 129

Ex Polyester enclosures



Type: **Ex e 06.08 19 06**

Ex ia 16.08 19 06



26.08 19 06

ATEX

h x w x d 75 x 190 x 56 mm



518 g

l in mm	in mm	N	N						
TS 15									
174	148,5		•	•	•	•		•	•

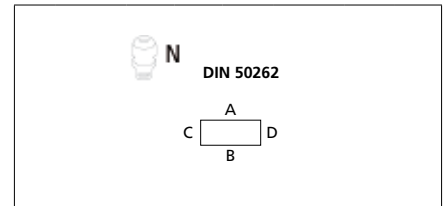

		1,5	2,5	4	6	10	16	25	35	50	70	95
	**	28	28									
	N	1	1									
	6											
	10	28										
	16	9	19									
	20	4	11									
	25		5									
	35											
	50											
	63											
	80											
	100											
	125											
	160											
	200											
	225											
	250											
	315											
400												
500												

M		Side		PG		Side	
		A/B	C/D			A/B	C/D
12	17,25	16	4	7	17,25	16	4
16	25,30	7	1	9	21,85	12	2
20	27,60	5	1	11	25,30	7	1
25	37,95	4	1	13,5	27,60	5	1
32	48,30			16	31,05	4	1
40	60,95			21	37,95	4	1
50	69,00			29	48,30		
63	74,75			36	60,95		
				42	69,00		
				48	74,75		

** Base: Terminal block Phoenix Contact, further see page 128 + 129

Type: **Ex e 06.08 19 08**

Ex ia 16.08 19 08



26.08 19 08

ATEX

h x w x d 75 x 190 x 75 mm



605 g

l in mm	in mm	N	N						
TS 15		36x6 mm²							
174	148,5	2	•	•	•	•		•	•

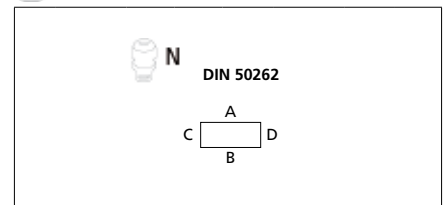

		1,5	2,5	4	6	10	16	25	35	50	70	95
	**	29	29	24								
	N	1	1	1								
	6											
	10	33										
	16	11	22	87								
	20	4	13	25								
	25		6	14								
	35			4								
	50											
	63											
	80											
	100											
	125											
	160											
	200											
	225											
	250											
	315											
400												
500												

M		Side		PG		Side	
		A/B	C/D			A/B	C/D
12	17,25	28	6	7	17,25	27	5
16	25,30	12	2	9	21,85	18	3
20	27,60	12	2	11	25,30	12	2
25	37,95	5	1	13,5	27,60	12	2
32	48,30	3	1	16	31,05	10	1
40	60,95			21	37,95	5	1
50	69,00			29	48,30	3	
63	74,75			36	60,95		
				42	69,00		
				48	74,75		

** Base: Terminal block Phoenix Contact, further see page 128 + 129

Ex Polyester enclosures













Type: **Ex e 06.08 23 06** **Ex ia 16.08 23 06**  **26.08 23 06**





ATEX

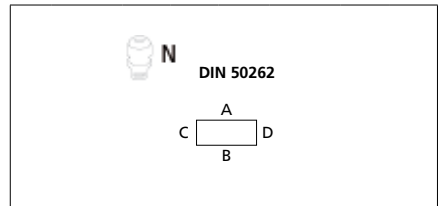

h x w x d 75 x 230 x 56 mm

 **613 g**

									
l in mm	in mm	N	N						
TS 15									
218	188,5		•	•	•	•	•	•	•



	1,5	2,5	4	6	10	16	25	35	50	70	95
	**	36	36								
 N		1	1								
 A	6										
	10	28									
	16	9	19								
	20	4	11								
	25		5								
	35										
	50										
	63										
	80										
	100										
	125										
	160										
	200										
	225										
	250										
	315										
400											
500											

M		Side		PG		Side	
		A/B	C/D			A/B	C/D
12	17,25	22	3	7	17,25	20	3
16	25,30	10	1	9	21,85	14	1
20	27,60	8	1	11	25,30	8	1
25	37,95	4	1	13,5	27,60	8	1
32	48,30			16	31,05	6	1
40	60,95			21	37,95	4	1
50	69,00			29	48,30		
63	74,75			36	60,95		
				42	69,00		
				48	74,75		











** Base: Terminal block Phoenix Contact, further see page 128 + 129

Type: **Ex e 06.08 23 08** **Ex ia 16.08 23 08**  **26.08 23 08**





ATEX

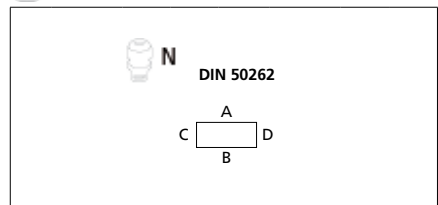

h x w x d 75 x 230 x 75 mm

 **726 g**

									
l in mm	in mm	N	N						
TS 15									
218	188,5		•	•	•	•	•	•	•



	1,5	2,5	4	6	10	16	25	35	50	70	95
	**	37	37	31							
 N		1	1	1							
 A	6										
	10	33									
	16	11	22	86							
	20	4	13	25							
	25		6	14							
	35			4							
	50										
	63										
	80										
	100										
	125										
	160										
	200										
	225										
	250										
	315										
400											
500											

M		Side		PG		Side	
		A/B	C/D			A/B	C/D
12	17,25	30	6	7	17,25	30	6
16	25,30	16	2	9	21,85	18	3
20	27,60	12	2	11	25,30	16	2
25	37,95	6	1	13,5	27,60	12	2
32	48,30	4	1	16	31,05	10	1
40	60,95			21	37,95	6	1
50	69,00			29	48,30	4	
63	74,75			36	60,95		
				42	69,00		
				48	74,75		

** Base: Terminal block Phoenix Contact, further see page 128 + 129

Ex Polyester enclosures



Type: **Ex e 06.12 12 09**

Ex ia 16.12 12 09



26.12 12 09

ATEX

h x w x d 120 x 122 x 91 mm



780 g

l in mm	in mm	N	N						
TS 35									
107	65		•	•	•	•	•	•	•

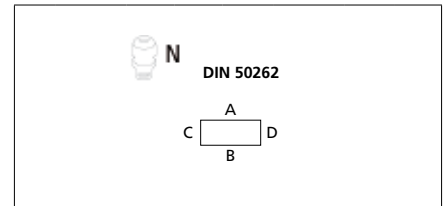

		1,5	2,5	4	6	10	16	25	35	50	70	95
	**	19	15	13	10	8	6					
	N	1	1	1	1	1	1					
	6											
	10	43										
	16	14	28	111								
	20	6	16	32								
	25		8	18	35							
	35			5	13	34						
	50				2	11	28					
	63					3	13					
	80						5					
	100											
	125											
	160											
	200											
	225											
	250											
	315											
400												
500												

M		Side		PG		Side	
		A/B	C/D			A/B	C/D
12	17,25	12	12	7	17,25	12	12
16	25,30	5	5	9	21,85	8	6
20	27,60	4	4	11	25,30	5	5
25	37,95	2	2	13,5	27,60	4	4
32	48,30	1	1	16	31,05	4	3
40	60,95	1	1	21	37,95	2	2
50	69,00			29	48,30	1	1
63	74,75			36	60,95	1	1
				42	69,00		
				48	74,75		

** Base: Terminal block Phoenix Contact, further see page 128 + 129

Type: **Ex e 06.12 22 09**

Ex ia 16.12 22 09



26.12 22 09

ATEX

h x w x d 120 x 220 x 91 mm



1102 g

l in mm	in mm	N	N						
TS 35									
205	166,5		•	•	•	•	•	•	•

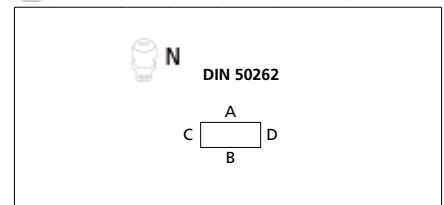

		1,5	2,5	4	6	10	16	25	35	50	70	95
	**	42	34	29	21	17	14					
	N	1	1	1	1	1	1					
	6											
	10	46										
	16	15	30	119								
	20	6	18	34								
	25		8	19	37							
	35			5	14	36						
	50				2	12	30					
	63					4	14					
	80						5					
	100											
	125											
	160											
	200											
	225											
	250											
	315											
400												
500												

M		Side		PG		Side	
		A/B	C/D			A/B	C/D
12	17,25	32	12	7	17,25	30	12
16	25,30	14	5	9	21,85	21	6
20	27,60	12	4	11	25,30	14	5
25	37,95	6	2	13,5	27,60	12	4
32	48,30	3	1	16	31,05	10	3
40	60,95	2	1	21	37,95	6	2
50	69,00			29	48,30	3	1
63	74,75			36	60,95	2	1
				42	69,00		
				48	74,75		

** Base: Terminal block Phoenix Contact, further see page 128 + 129

Ex Polyester enclosures



Type: **Ex e 06.16 16 09**

Ex ia 16.16 16 09



26.16 16 09

ATEX

h x w x d 160 x 160 x 91 mm

1307 g

l in mm	in mm	N	N							
TS 35		10 x 6 mm ²								
144	105	1		•	•	•	•	•	•	•

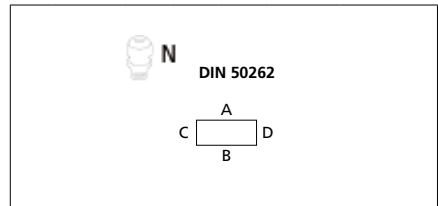

		1,5	2,5	4	6	10	16	25	35	50	70	95
	**	28	23	19	14	11	9	7	7			
	N	1	1	1	1	1	1	1	1			
	6											
	10	48										
	16	16	32	125								
	20	7	19	36								
	25		9	20	39							
	35			6	15	38						
	50				2	12	32					
	63					4	14	52				
	80						5	16	59			
	100							7	15			
	125								6			
	160											
	200											
	225											
	250											
315												
400												
500												

M		Side		PG		Side	
		A/B	C/D			A/B	C/D
12	17,25	26	18	7	17,25	26	18
16	25,30	14	8	9	21,85	15	12
20	27,60	9	6	11	25,30	12	8
25	37,95	6	3	13,5	27,60	9	6
32	48,30	3	2	16	31,05	8	6
40	60,95	2	1	21	37,95	6	3
50	69,00	2	1	29	48,30	2	2
63	74,75			36	60,95	2	1
				42	69,00	1	
				48	74,75		

** Base: Terminal block Phoenix Contact, further see page 128 + 129

Type: **Ex e 06.16 26 09**

Ex ia 16.16 26 09



26.16 26 09

ATEX

h x w x d 160 x 260 x 91 mm

1797 g

l in mm	in mm	N	N							
TS 35		22 x 6 mm ²								
245	205	1		•	•	•	•	•	•	•

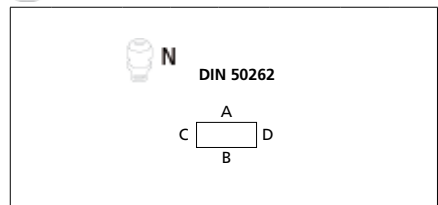

		1,5	2,5	4	6	10	16	25	35	50	70	95
	**	52	42	35	26	21	18	14	14			
	N	1	1	1	1	1	1	1	1			
	6											
	10	52										
	16	18	35	136								
	20	7	20	39								
	25		9	22	43							
	35			6	16	41						
	50				2	13	34					
	63					4	16	57				
	80						6	17	64			
	100							7	16			
	125								6			
	160											
	200											
	225											
	250											
315												
400												
500												

M		Side		PG		Side	
		A/B	C/D			A/B	C/D
12	17,25	50	16	7	17,25	50	15
16	25,30	26	8	9	21,85	30	11
20	27,60	17	6	11	25,30	21	6
25	37,95	11	3	13,5	27,60	17	6
32	48,30	5	2	16	31,05	14	5
40	60,95	3	1	21	37,95	11	3
50	69,00	3		29	48,30	5	2
63	74,75			36	60,95	3	1
				42	69,00	3	
				48	74,75		

** Base: Terminal block Phoenix Contact, further see page 128 + 129

Ex Polyester enclosures



Type: **Ex e 06.16 36 09**

Ex ia 16.16 36 09



26.16 36 09

ATEX

h x w x d 160 x 360 x 91 mm

2273 g

l in mm	in mm	N	N								
TS 35		32 x 6 mm ²									
343	302	1			•	•	•	•	•	•	•

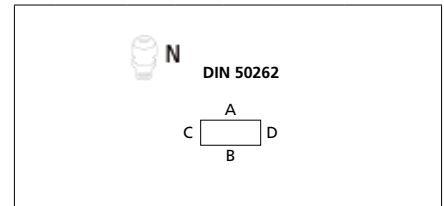

	1,5	2,5	4	6	10	16	25	35	50	70	95
	1	1	1	1	1	1	1	1			
	6										
	10	53									
	16	18	35	138							
	20	7	20	40							
	25		9	22	43						
	35			6	17	42					
	50				2	14	35				
	63					4	16	58			
	80						6	18	65		
	100							7	17		
	125								7		
	160										
	200										
	225										
	250										
	315										
400											
500											

M		Side		PG		Side	
		A/B	C/D			A/B	C/D
12	17,25	72	18	7	17,25	72	18
16	25,30	38	8	9	21,85	42	12
20	27,60	26	6	11	25,30	36	8
25	37,95	16	3	13,5	27,60	26	6
32	48,30	7	2	16	31,05	20	6
40	60,95	5	1	21	37,95	16	3
50	69,00	4	1	29	48,30	7	2
63	74,75			36	60,95	5	1
				42	69,00	4	
				48	74,75		

** Base: Terminal block Phoenix Contact, further see page 128 + 129

Type: **Ex e 06.16 56 09**

Ex ia 16.16 56 09



26.16 56 09

ATEX

h x w x d 160 x 560 x 91 mm

3294 g

l in mm	in mm	N	N								
TS 35		50 x 6 mm ²									
543	508	1			•	•	•	•	•	•	•

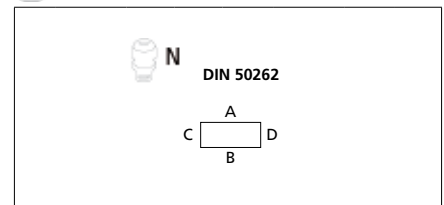

	1,5	2,5	4	6	10	16	25	35	50	70	95
	1	1	1	1	1	1	1	1			
	6										
	10	53									
	16	18	35	138							
	20	7	20	40							
	25		9	22	43						
	35			6	17	42					
	50				2	14	35				
	63					4	16	58			
	80						6	18	65		
	100							7	17		
	125								7		
	160										
	200										
	225										
	250										
	315										
400											
500											

M		Side		PG		Side	
		A/B	C/D			A/B	C/D
12	17,25	112	18	7	17,25	112	18
16	25,30	58	8	9	21,85	66	12
20	27,60	40	6	11	25,30	52	8
25	37,95	24	3	13,5	27,60	40	6
32	48,30	12	2	16	31,05	32	6
40	60,95	8	1	21	37,95	22	3
50	69,00	6	1	29	48,30	10	2
63	74,75			36	60,95	8	1
				42	69,00	6	
				48	74,75		

** Base: Terminal block Phoenix Contact, further see page 128 + 129

Ex Polyester enclosures















Type: **Ex e 06.25 26 12** **Ex ia 16.25 26 12**  **26.25 26 12**





ATEX

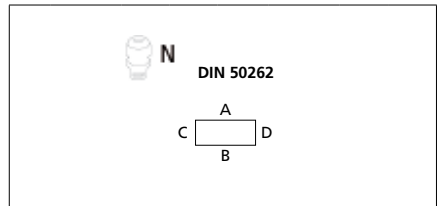

h x w x d 250 x 255 x 121 mm

 **2820 g**

											
l in mm	in mm	N	N								
TS 35		22 x 6 mm ²									
238	197	2			•	•	•	•	•	•	•



	1,5	2,5	4	6	10	16	25	35	50	70	95
	**	102	82	68	52	21	17	14	14	10	
 N		2	2	2	2	1	1	1	1	1	
 A	6										
	10	70									
	16	24	47	182							
	20	10	27	52							
	25		13	30	57						
	35			8	22	56					
	50				3	18	46				
	63					6	21	76			
	80						8	24	85		
	100							10	22		
	125								9	22	
	160									7	
	200										
	225										
	250										
	315										
400											
500											

M		Side		PG		Side	
		A/B	C/D			A/B	C/D
12	17,25	69	51	7	17,25	69	51
16	25,30	32	24	9	21,85	40	32
20	27,60	24	18	11	25,30	32	24
25	37,95	12	10	13,5	27,60	24	18
32	48,30	8	7	16	31,05	21	17
40	60,95	4	3	21	37,95	12	9
50	69,00	3	3	29	48,30	8	6
63	74,75	3	2	36	60,95	4	3
				42	69,00	3	2
				48	74,75	3	2













** Base: Terminal block Phoenix Contact, further see page 128 + 129

Type: **Ex e 06.25 26 16** **Ex ia 16.25 26 16**  **26.25 26 16**





ATEX

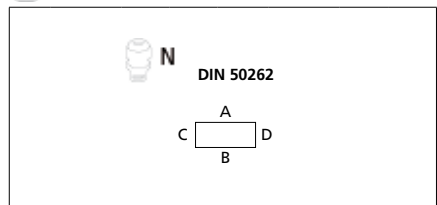

h x w x d 250 x 255 x 161 mm

 **3515 g**

											
l in mm	in mm	N	N								
TS 35		22 x 6 mm ²									
238	197	2			•	•	•	•	•	•	•



	1,5	2,5	4	6	10	16	25	35	50	70	95
	**	102	82	68	52	21	17	14	14	10	8
 N		2	2	2	2	1	1	1	1	1	1
 A	6										
	10	82									
	16	28	54	211							
	20	11	31	61							
	25		15	34	67						
	35			10	26	65					
	50				3	21	54				
	63					7	25	88			
	80						9	27	99		
	100							12	26		
	125								10	26	
	160									9	23
	200										8
	225										3
	250										
	315										
400											
500											

M		Side		PG		Side	
		A/B	C/D			A/B	C/D
12	17,25	69	51	7	17,25	69	51
16	25,30	32	24	9	21,85	40	32
20	27,60	24	18	11	25,30	32	24
25	37,95	12	10	13,5	27,60	24	18
32	48,30	8	7	16	31,05	21	17
40	60,95	4	3	21	37,95	12	9
50	69,00	3	3	29	48,30	8	6
63	74,75	3	2	36	60,95	4	3
				42	69,00	3	2
				48	74,75	3	2

** Base: Terminal block Phoenix Contact, further see page 128 + 129

Ex Polyester enclosures



Type: **Ex e 06.25 40 12**

Ex ia 16.25 40 12



26.25 40 12

ATEX

h x w x d 250 x 400 x 121 mm

3741 g

l in mm	in mm	N	N								
TS 35		36 x 6 mm ²									
381	342	2									

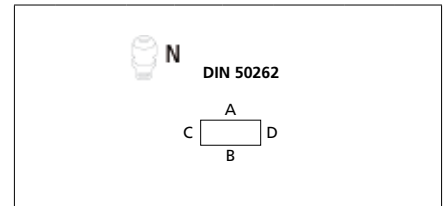

	1,5	2,5	4	6	10	16	25	35	50	70	95
	**	170	138	116	86	35	29	23	23	18	
	N	2	2	2	2	1	1	1	1	1	
	6										
	10	76									
	16	26	50	197							
	20	10	29	57							
	25		14	32	62						
	35			9	24	60					
	50				3	19	50				
	63					6	23	82			
	80						9	26	92		
	100							11	24		
	125								9	24	
	160									8	
	200										
	225										
	250										
	315										
400											
500											

M		Side		PG		Side	
		A/B	C/D			A/B	C/D
12	17,25	117	50	7	17,25	114	50
16	25,30	56	22	9	21,85	68	32
20	27,60	42	18	11	25,30	56	21
25	37,95	21	10	13,5	27,60	40	18
32	48,30	14	6	16	31,05	33	17
40	60,95	7	3	21	37,95	21	9
50	69,00	5	2	29	48,30	14	5
63	74,75	5	2	36	60,95	7	3
				42	69,00	5	2
				48	74,75	5	2

** Base: Terminal block Phoenix Contact, further see page 128 + 129

Type: **Ex e 06.25 40 16**

Ex ia 16.25 40 16



26.25 40 16

ATEX

h x w x d 250 x 400 x 161 mm

4800 g

l in mm	in mm	N	N								
TS 35		36 x 6 mm ²									
381	342	2									

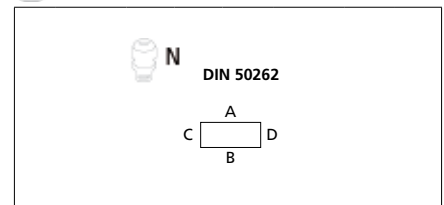

	1,5	2,5	4	6	10	16	25	35	50	70	95
	**	170	138	116	86	35	29	23	23	18	14
	N	2	2	2	2	1	1	1	1	1	1
	6										
	10	87									
	16	30	58	226							
	20	12	34	65							
	25		16	37	71						
	35			11	28	69					
	50				4	22	57				
	63					7	26	95			
	80						10	29	106		
	100							12	28		
	125								11	28	
	160									9	25
	200										9
	225										3
	250										
	315										
400											
500											

M		Side		PG		Side	
		A/B	C/D			A/B	C/D
12	17,25	117	50	7	17,25	114	50
16	25,30	56	24	9	21,85	68	32
20	27,60	42	18	11	25,30	56	22
25	37,95	21	10	13,5	27,60	40	18
32	48,30	14	7	16	31,05	33	17
40	60,95	7	3	21	37,95	21	9
50	69,00	5	3	29	48,30	14	6
63	74,75	5	2	36	60,95	7	3
				42	69,00	5	2
				48	74,75	5	2

** Base: Terminal block Phoenix Contact, further see page 128 + 129

Ex Polyester enclosures













Type: **Ex e 06.25 60 12** **Ex ia 16.25 60 12**  **26.25 60 12**





ATEX

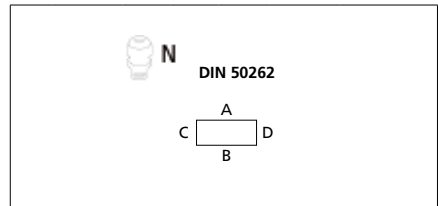

h x w x d 250 x 600 x 121 mm

 **5520 g**

									
l in mm	in mm	N	N						
TS 35		56 x 6 mm ²							
581	542	2		•	•	•	•	•	•



		1,5	2,5	4	6	10	16	25	35	50	70	95
	**	266	214	180	136	54	45	36	36	28		
	N	2	2	2	2	1	1	1	1	1		
	6											
	10	78										
	16	27	52	202								
	20	11	30	58								
	25		14	33	64							
	35			9	25	62						
	50				3	20	51					
	63					6	24	85				
	80						9	26	95			
	100							11	25			
	125								10	25		
	160									8		
	200											
	225											
	250											
	315											
400												
500												

M		Side		PG		Side	
		A/B	C/D			A/B	C/D
12	17,25	108	50	7	17,25	108	50
16	25,30	52	24	9	21,85	64	32
20	27,60	36	18	11	25,30	48	22
25	37,95	30	10	13,5	27,60	36	18
32	48,30	12	7	16	31,05	30	17
40	60,95	6	3	21	37,95	18	9
50	69,00	4	3	29	48,30	12	6
63	74,75	4	2	36	60,95	6	3
				42	69,00	4	2
				48	74,75	4	2











** Base: Terminal block Phoenix Contact, further see page 128 + 129

Type: **Ex e 06.36 36 09** **Ex ia 16.36 36 09**  **26.36 36 09**





ATEX

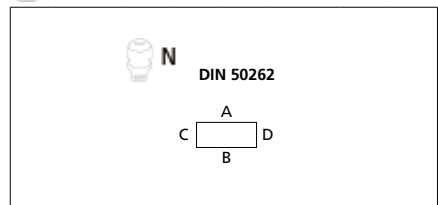

h x w x d 360 x 360 x 91 mm

 **4400 g**

									
l in mm	in mm	N	N						
TS 35		36 x 6 mm ²							
343	304	2		•	•	•	•	•	•



		1,5	2,5	4	6	10	16	25	35	50	70	95
	**	228	183	153	78	62	52	42	42			
	N	3	3	3	2	2	2	2	2			
	6											
	10	77										
	16	26	51	199								
	20	11	30	58								
	25		14	32	63							
	35			9	24	61						
	50				3	20	50					
	63					6	23	83				
	80						9	26	93			
	100							11	24			
	125								10			
	160											
	200											
	225											
	250											
	315											
400												
500												

M		Side		PG		Side	
		A/B	C/D			A/B	C/D
12	17,25	72	52	7	17,25	72	52
16	25,30	38	24	9	21,85	42	38
20	27,60	26	20	11	25,30	33	23
25	37,95	16	10	13,5	27,60	26	20
32	48,30	7	6	16	31,05	20	18
40	60,95	5	5	21	37,95	15	9
50	69,00	4		29	48,30	7	6
63	74,75			36	60,95	5	4
				42	69,00	4	
				48	74,75		

** Base: Terminal block Phoenix Contact, further see page 128 + 129

Ex Polyester enclosures



Type: **Ex e 06.41 40 12**

Ex ia 16.41 40 12



26.41 40 12

ATEX

h x w x d 405 x 400 x 121 mm

5760 g

l in mm	in mm	N	N						
TS 35		36 x 6 mm ²							
381	342	2			•	•	•	•	•

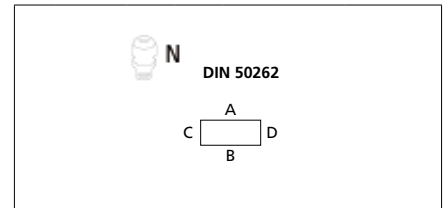

	1,5	2,5	4	6	10	16	25	35	50	70	95
	**	255	207	174	129	70	58	23	23	18	
	N	3	3	3	3	2	2	1	1	1	
	6										
	10	92									
	16	31	61	237							
	20	13	35	69							
	25		17	39	75						
	35			11	29	73					
	50				4	24	60				
	63					8	28	99			
	80						10	31	111		
	100							13	29		
	125								12	29	
	160									10	
	200										
	225										
	250										
	315										
400											
500											

M		Side		PG		Side	
		A/B	C/D			A/B	C/D
12	17,25	117	95	7	17,25	114	95
16	25,30	56	46	9	21,85	68	60
20	27,60	42	36	11	25,30	56	44
25	37,95	21	18	13,5	27,60	40	36
32	48,30	14	13	16	31,05	33	32
40	60,95	7	6	21	37,95	21	18
50	69,00	5	5	29	48,30	14	12
63	74,75	5	4	36	60,95	7	6
				42	69,00	5	5
				48	74,75	5	4

** Base: Terminal block Phoenix Contact, further see page 128 + 129

Ex Polyester enclosures





Type: **Ex e 06.41 40 20**











Ex ia 16.41 40 20





 **26.41 40 20**

ATEX



 **406 x 401 x 201 mm**



 **7424 g**

									
l in mm	in mm	N	N						
TS 35		36 x 6 mm ²							
381	342	2		•	•	•	•	•	•

		1,5	2,5	4	6	10	16	25	35	50	70	95	120	150
	**	255	207	174	129	70	58	23	23	18	14	14	11	11
	N	3	3	3	3	2	2	1	1	1	1	1	1	1
 A	6													
	10	114												
	16	39	76	295										
	20	16	44	85										
	25		21	48	93									
	35			14	36	91								
	50				5	29	75							
	63					10	35	124						
	80						13	39	139					
	100							16	36					
	125								14	37				
	160									12	32			
	200										11	28	87	
	225										4	16	34	
	250											8	21	43
	315												4	12
400														
500														

** Base: Terminal block Phoenix Contact, further see page 128 + 129

 **N**
DIN 50262

M		Side		PG		Side	
		A/B	C/D			A/B	C/D
12	17,25	210	190	7	17,25	205	190
16	25,30	98	91	9	21,85	128	120
20	27,60	88	77	11	25,30	98	91
25	37,95	45	43	13,5	27,60	88	77
32	48,30	28	26	16	31,05	66	63
40	60,95	17	15	21	37,95	45	40
50	69,00	12	11	29	48,30	28	24
63	74,75	9	8	36	60,95	17	15
				42	69,00	11	11
				48	74,75	10	8

Ex Polyester enclosures



Type	A	B	C	D	E	F	G	H	J	K	L	M	N	O
06/16/26.08 08 06	80	66	51	80	68	59	50	71	56,5	41,5	8	46	1	8,5
06/16/26.08 08 08	80	66	51	80	68	59	50	71	75,5	60,5		65		9,5
06/16/26.08 11 06	110	96	81	110	98	89	80	101	56,5	41,5	8	46	1	8,5
06/16/26.08 11 08	110	96	81	110	98	89	80	101	75,5	60,5		65		9,5
06/16/26.08 16 06	160	146	131	160	148	139	130	151	56,5	41,5	8	46	1	8,5
06/16/26.08 16 08	160	146	131	160	148	139	130	151	75,5	60,5		65		9,5
06/16/26.08 19 06	190	176	161	190	178	169	160	181	56,5	41,5		46		8,5
06/16/26.08 19 08	190	176	161	190	178	169	160	181	75,5	60,5		65		9,5

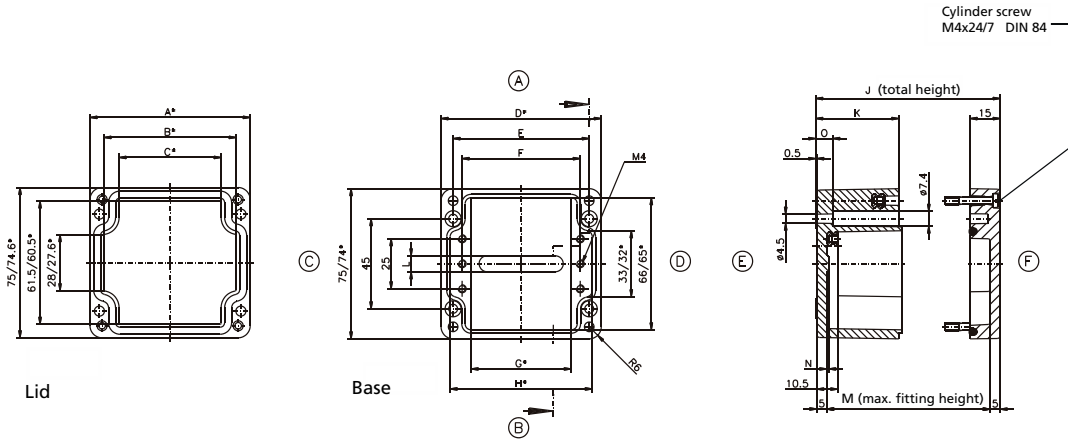

Type	A	B	C	D
06/16/26.08 23 06	56	46	41	10
06/16/26.08 23 08	75	65	60	9

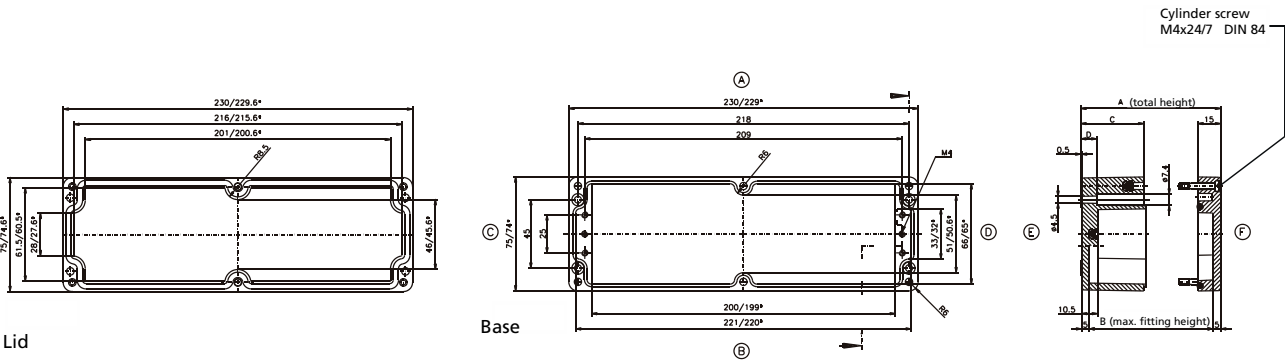

Type	A	B	C	D	E	F	G	H	J
06/16/26.12 12 09	122	108	85	122	106	95	82	113	5
06/16/26.12 22 09	220	206	183	220	204	193	180	211	

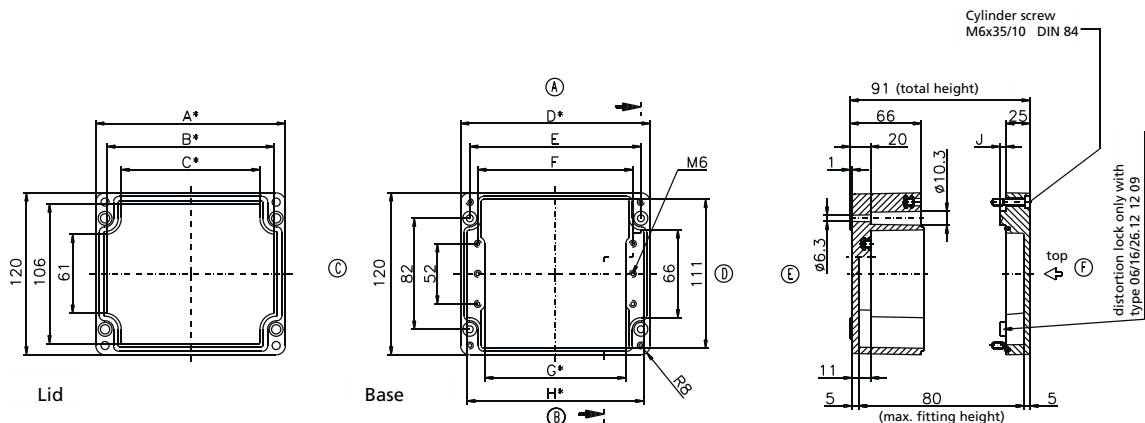

Ex Polyester enclosures



Type	A	B	C	D	E	F	G	H	J
06/16/26.16 16 09	160	142	114	160	140	132	120	148	5,5
06/16/26.16 26 09	260	242	214	260	240	232	220	248	
06/16/26.16 36 09	360	342	314	360	340	332	320	348	

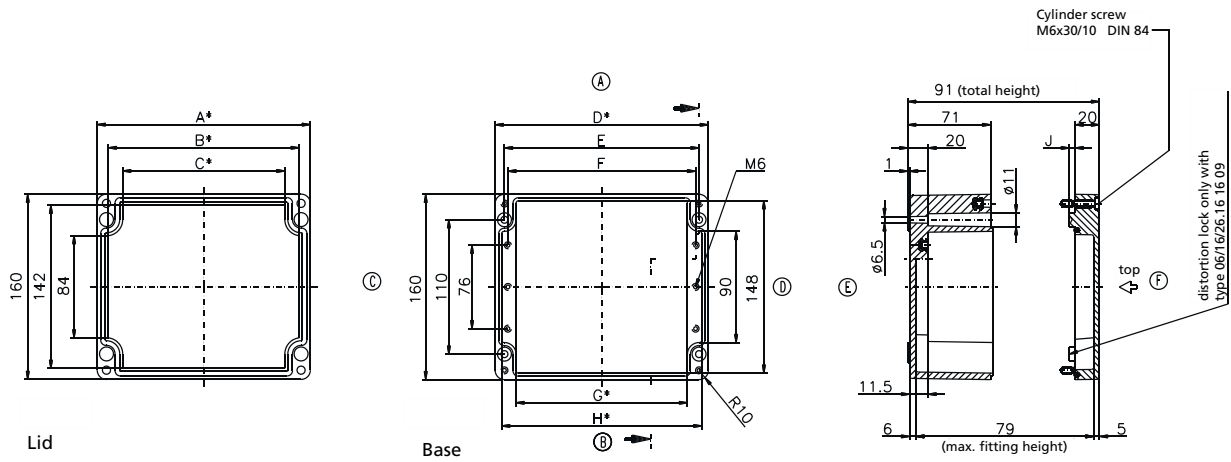

Type: **06/16/26.16 56 09**

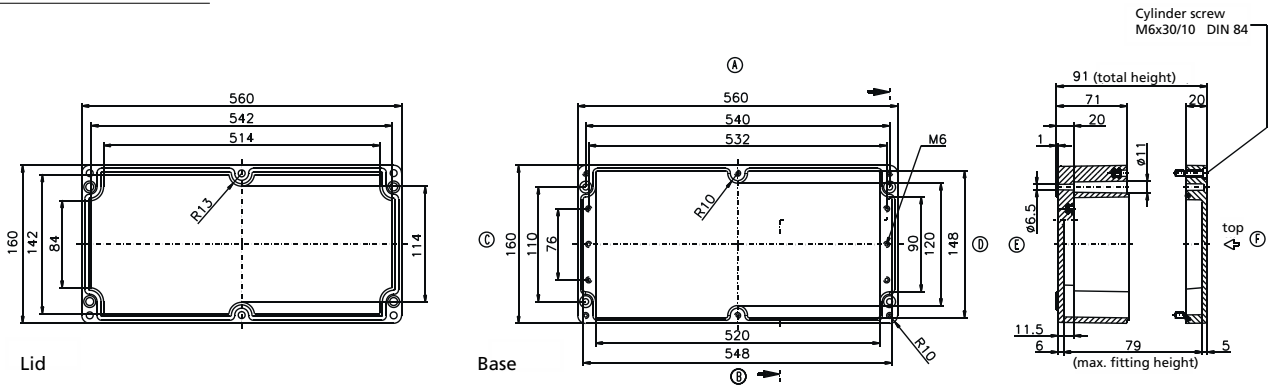

Type	A	B	C	D	E	F	G	H	J	K	L	M	N	O	P	Q	R	S	T	U
06/16/26.25 26 12	255	250	237	232	209	174	255	250	235	200	227	100	243	238	215	180	121	96	25	109
06/16/26.25 26 16	255	250	237	232	209	174	255	250	235	200	227	100	243	238	215	180	161	96	65	149
06/16/26.25 40 12	400	250	382	232	354	174	400	250	380	200	372	100	388	238	360	180	121	96	25	109
06/16/26.25 40 16	400	250	382	232	354	174	400	250	380	200	372	100	388	238	360	180	161	96	65	149

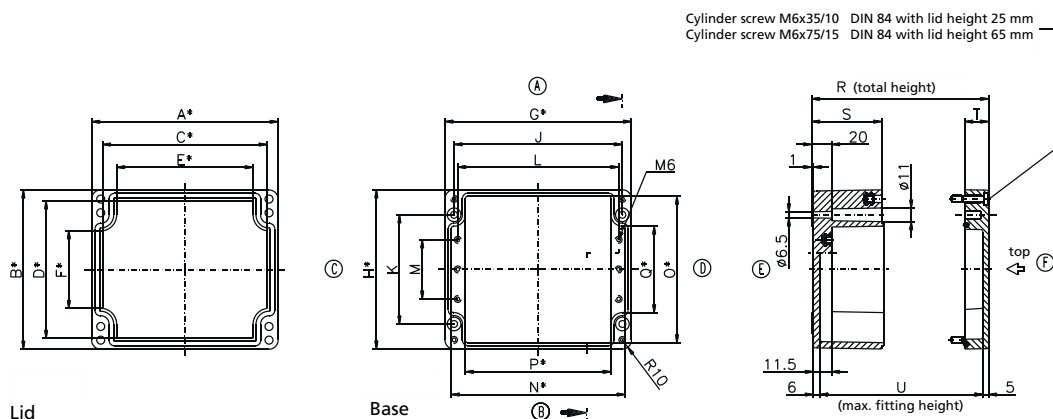

Ex Polyester enclosures



Type: **06/16/26.25 60 12**

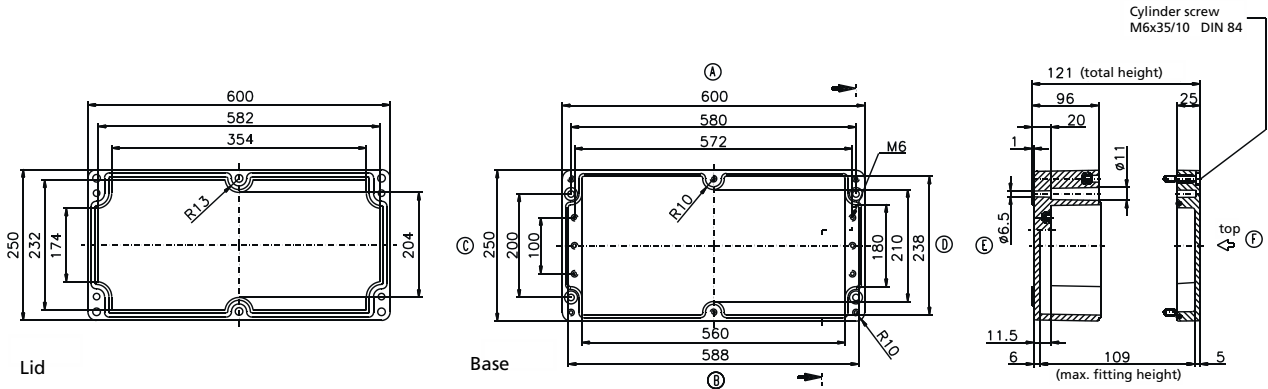

Type: **06/16/26.36 36 09**

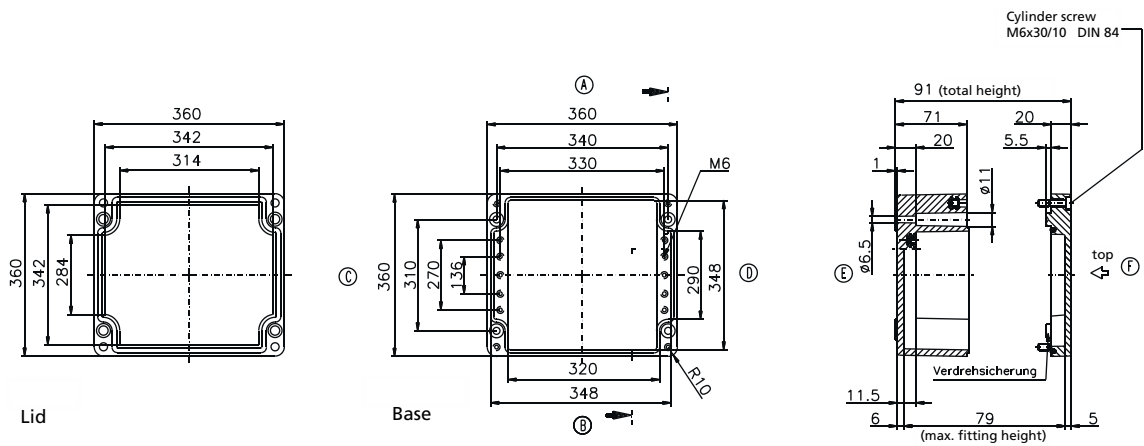

Type	A	B	C	D	E	F	G	H	J
06/16/26.41 40 12	400	405	360	335	388	393	121	96	109
06/16/26.41 40 20	401	406	360	335	388	393	201	176	189

