



DME375A

375 Watts, 50 Volts, Pulsed
Avionics 1025-1150 MHz

GENERAL DESCRIPTION

The DME375A is a high power COMMON BASE bipolar transistor. It is designed for pulsed systems in the frequency band 1025-1150 MHz. The device has gold thin-film metallization for proven highest MTTF. The transistor includes input and output prematch for broadband capability. Low thermal resistance package reduces junction temperature, extends life.

CASE OUTLINE 55AW Style 1

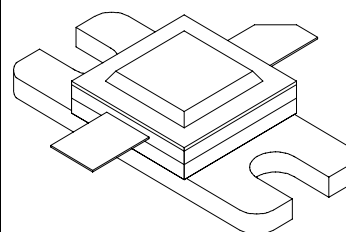

ABSOLUTE MAXIMUM RATINGS

Maximum Power Dissipation

Device Dissipation @25°C² 875 W

Maximum Voltage and Current

Collector to Base Voltage (BV_{ces}) 55 V

Emitter to Base Voltage (BV_{ebo}) 4.0 V

Collector Current (I_c) 30 A

Maximum Temperatures

Storage Temperature -65 to +200 °C

Operating Junction Temperature +200 °C

ELECTRICAL CHARACTERISTICS @ 25°C

SYMBOL	CHARACTERISTICS	TEST CONDITIONS	MIN	TYP	MAX	UNITS
P _{out}	Power Out	F = 1025 – 1150 MHz	375			W
P _{in}	Power Input	V _{cc} = 50 Volts			85	W
P _g	Power Gain	PW = 10 μsec	6.5			dB
η _c	Collector Efficiency	DF = 1%		40		%
VSWR ¹	Load Mismatch Tolerance	F = 1090 MHz			□:1	

FUNCTIONAL CHARACTERISTICS @ 25°C

BV _{ebo}	Emitter to Base Breakdown	I _e = 20 mA	4.0			V
BV _{ces}	Collector to Emitter Breakdown	I _c = 25 mA	55			V
h _{FE}	DC – Current Gain	V _{ce} = 5V, I _c = 300 mA	10			
θ _{jc} ²	Thermal Resistance				0.2	°C/W

NOTE 1: At rated output power and pulse conditions

2. At rated pulse conditions

Initial Issue June 1994

POWER OUTPUT

Vcc = 50 V, Pin = 85 W

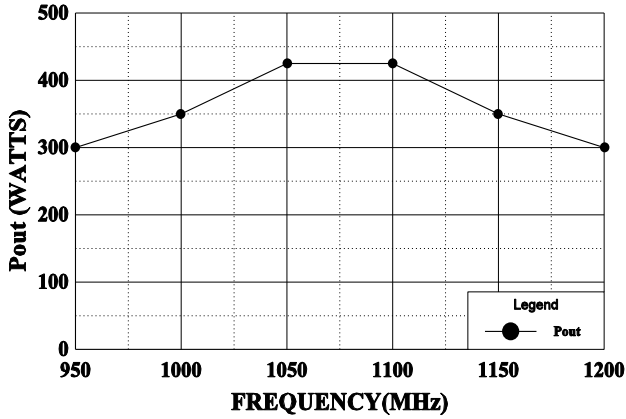

THERMAL RESISTANCE vs PULSE WIDTH

Vcc = 50 V, Tf = 30 C

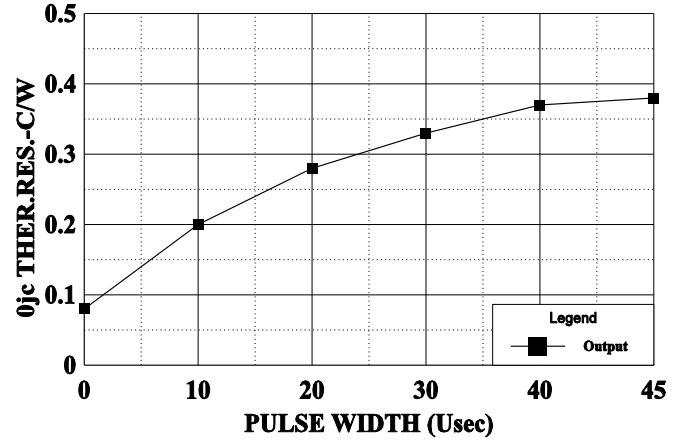

SERIES INPUT IMPEDANCE vs FREQUENCY

Vcc = 50 V, Po = 375 W

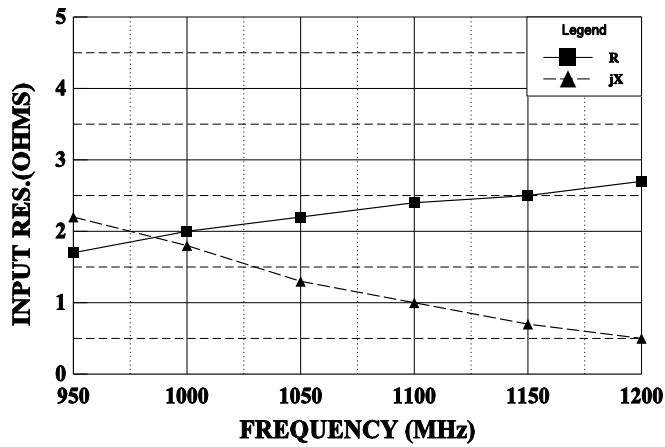

SERIES LOAD IMPEDANCE vs FREQUENCY

Vcc = 50 V, Po = 375 W

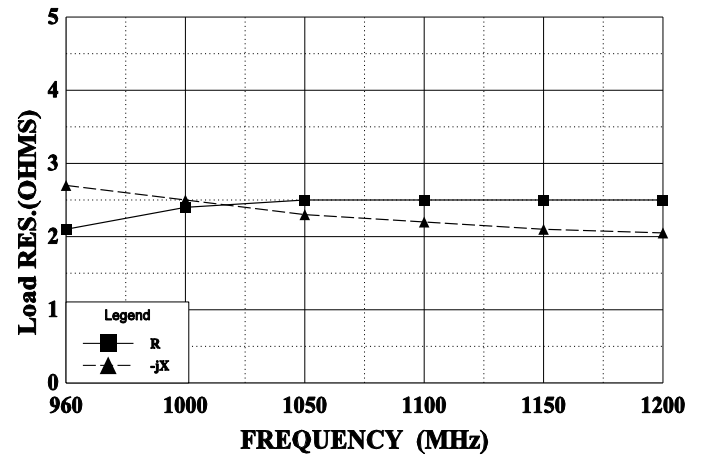

REVISIONS

ZONE	REV	DESCRIPTION	DATE	APPROVED
------	-----	-------------	------	----------

DIM	INCHES
A	1.260
B	1.100
C	.135
D	.400
E	.042
F	.450
G	.220
H	.360
I	.165
J	.125
K	.550
L	.550
M	.225
N	.225
O	.495
P	.215
Q	.230
R	.042
S	.400
T	.062

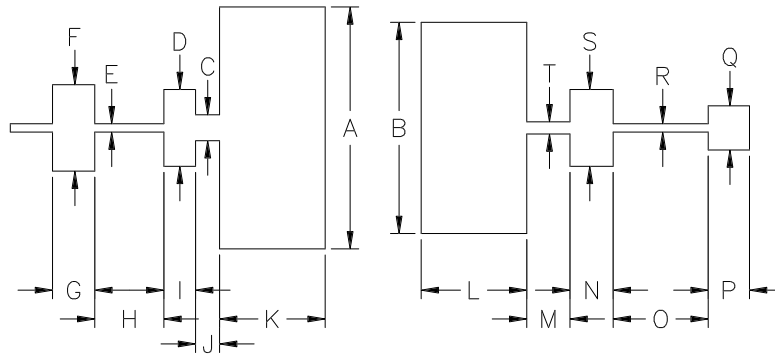

1025/1150 MHz TEST AMPLIFIER (FIG. 1)

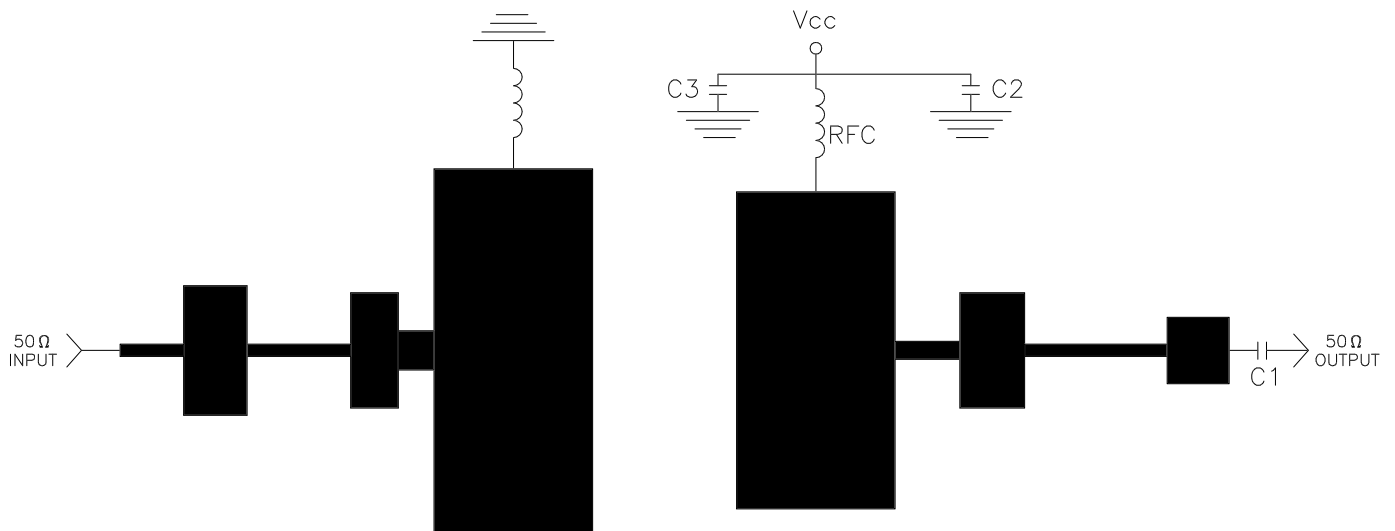

PCB= .020" TFE, 2 oz. CU. Type "GT"
 C1, C2= 82pf Chip
 C3= 250 MFD

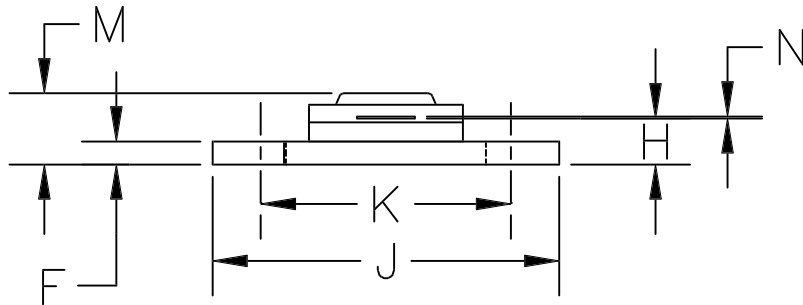
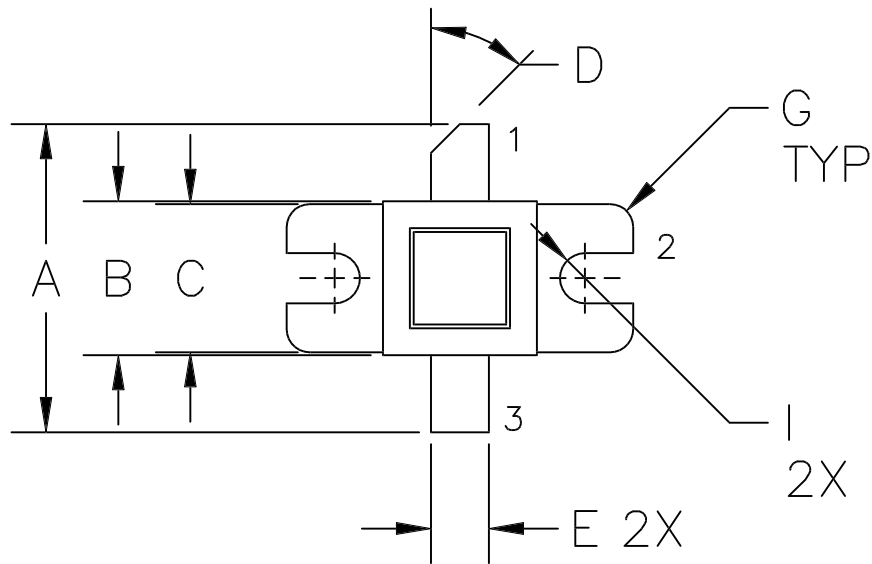

DIM	MILLIMETER	TOL	INCHES	TOL
A	20.32	.76	.800	.050
B	10.16	.13	.400	.005
C	9.78	.13	.385	.005
D	45°	5°	45°	5°
E	3.81	.13	.150	.005
F	1.52	.13	.060	.005
G	1.52R	.13	.060R	.005
H	3.05	.13	.120	.005
I	3.30 DIA	.13	.130 DIA	.005
J	22.86	.13	.900	.005
K	16.51	.13	.650	.005
M	4.70	REF	.185	REF
N	0.13	.02	.005	.001

STYLE 1:
 PIN1 = COLLECTOR
 2 = BASE
 3 = EMITTER

STYLE 2:
 PIN1 = COLLECTOR
 2 = EMITTER
 3 = BASE

