

**Instruction Manual**

---

# Contents

<b>SAFETY INFORMATION</b> .....	<b>3</b>
<b>QUICK START</b> .....	<b>5</b>
<b>MULTI-DISPLAY MULTIMETER</b> .....	<b>6</b>
■ INTRODUCTION.....	6
<b>GETTING START WITH YOUR METER</b> .....	<b>7</b>
■ DISPLAY ILLUSTRATION .....	7
■ ROTARY SWITCH.....	8
■ TERMINALS.....	9
■ PUSH-BUTTON OPERATIONS .....	10
<b>POWER-ON OPTION</b> .....	<b>13</b>
■ HOW TO ENTER SETUP MODE .....	13
■ FACTORY DEFAULT.....	13
■ BAUD RATE .....	15
■ PARITY CHECK.....	16
■ DATA BIT.....	16
■ ECHO .....	17
■ PRINT ONLY .....	17
■ PERCENTAGE (%) SCALE FOR 4-20MA OR 0-20MA MEASURING .....	18
■ MINIMUM FREQUENCY MEASURING .....	19
■ BEEP FREQUENCY .....	20
■ TEMPERATURE UNIT (REQUIRES OPTIONAL ADAPTER).....	21
■ DATA HOLD/REFRESH HOLD .....	22
■ ENVIRONMENT TEMPERATURE .....	23
■ AUTO POWER SAVING.....	24
■ THERMOCOUPLE TYPES (FOR MODEL 2890A ONLY) .....	25
■ BACKLIT DISPLAY .....	26
■ DECIBEL TYPES.....	27
■ REFERENCE IMPEDANCE FOR DBM .....	28
■ RESET TO DEFAULT.....	29
<b>BARGRAPH</b> .....	<b>30</b>
<b>A FREE-FOR-ALL APPLICATION FUNCTION</b> .....	<b>31</b>
■ SQUARE WAVE OUTPUT (FOR MODEL 2890A ONLY).....	31
<b>ALERTING</b> .....	<b>34</b>
■ OVERLOAD ALERT FOR VOLTAGE MEASUREMENT.....	34
■ INPUT WARNING.....	34
■ CHARGE TERMINAL ALERT.....	35
<b>CAPACITY CHECK OF BATTERY</b> .....	<b>36</b>
<b>CALCULATION FUNCTION</b> .....	<b>37</b>







■ DYNAMIC RECORDING .....	37
■ DATA HOLD.....	39
■ TRIGGER HOLD .....	39
■ REFRESH HOLD .....	40
■ RELATIVE (ZERO) .....	41
■ DECIBEL DISPLAY.....	42
■ PEAK HOLD.....	44
<b>REMOTE COMMUNICATION.....</b>	<b>46</b>
<b>MULTI-DISPLAY MULTIMETER.....</b>	<b>48</b>
■ SELECTION BY HZ BUTTON .....	48
■ SELECTION BY DUAL BUTTON (FOR MODEL 2890A).....	50
■ SELECTION BY DUAL BUTTON (FOR MODEL 2880B).....	53
■ SHIFT FUNCTION BY BLUE BUTTON (FOR MODEL 2890A).....	55
■ SHIFT FUNCTION BY BLUE BUTTON (FOR MODEL 2880B).....	58
<b>HOW TO OPERATE .....</b>	<b>60</b>
■ AC VOLTAGE MEASUREMENT .....	60
■ DC VOLTAGE MEASUREMENT .....	61
■ MA MEASUREMENT .....	62
■ MA MEASUREMENT .....	63
■ % SCALE OF 4-20MA.....	64
■ A MEASUREMENT .....	65
■ FREQUENCY COUNTER .....	66
■ RESISTANCE/ CONTINUITY MEASUREMENT.....	68
■ CONDUCTANCE MEASUREMENT .....	71
■ DIODE CHECK.....	73
■ CAPACITANCE.....	76
■ BIPOLAR JUNCTION TRANSISTOR.....	78
■ JFET SWITCH TEST .....	80
■ TEMPERATURE MEASUREMENT (OPTIONAL ADAPTER REQUIRED) .....	82
■ SQUARE WAVE OUTPUT.....	84
<b>SPECIFICATIONS.....</b>	<b>85</b>
■ GENERAL SPECIFICATION .....	85
■ ELECTRICAL SPECIFICATIONS FOR MODEL 2890A .....	88
■ ELECTRICAL SPECIFICATIONS FOR MODEL 2880B .....	98
<b>MAINTENANCE.....</b>	<b>104</b>
■ SERVICE.....	104
■ BATTERY REPLACEMENT (UNIT DOES NOT COME WITH A NI-MH BATTERY) 105	
■ HOW TO CHARGE BATTERY (OPTIONAL ACCESSORY REQUIRED) .....	107
■ FUSE REPLACEMENT .....	112
■ CLEANING .....	113
INCLUDE WITH THE RETURNED INSTRUMENT YOUR COMPLETE RETURN SHIPPING ADDRESS, CONTACT NAME, PHONE NUMBER AND DESCRIPTION OF PROBLEM. ....	114

## SAFETY INFORMATION

This meter is a hand-held, battery-operated instrument for testing and troubleshooting power electronic systems. If this device is damaged or something is missing, contact the purchasing place immediately.

A **WARNING** identifies conditions and actions that may cause hazard(s) to the user; a **CAUTION** identifies conditions and actions that may damage this Device. Following **Table-1** explain international electrical symbols used on this meter.

**Table- 1 International Electrical Symbols**

	AC - Alternating Current
	DC - Direct Current
	AC and DC - Alternating and Direct Current
	Ground
	Double Insulation
	See Explanation In The Manual

## □ SAFETY INFORMATION

### *Warnings and Cautions*

**To avoid electric shock, injury, or damage to this instrument and ensure that you use the meter safely, follow the safety guidelines listed below:**

- Read this operation manual completely before using this device and follow all safety instructions.
- This device is for indoor use, altitude up to 2,000m.
- Avoid working alone.
- Use the device only as specified in this manual; otherwise, the protection provided by the meter may be impaired.
- Never measure Voltage when the current measurement is selected.
- Do not use this device if it looks damaged.
- Inspect the leads for damaged insulation or exposed metal. Replace damaged leads.
- Disconnect the power and discharge all high-voltage capacitors before testing in the resistance, continuity, and diode function.
- Be cautious when working above 70VDC or 33VRMS and 46.7V peak, such voltages may cause a shock hazard.
- Always keep your hands behind the protective guard of the probe as measuring.
- Select the proper function and disconnect the test leads from test points before changing functions.
- Always use specified battery.
- The meter is safety-certified in compliance with EN61010 (IEC 1010-1, IEC 1010-2-031) Installation Category IV 600V/ III 1000V Pollution Degree 2. In order to maintain its insulation properties, please be sure to use with the standard or compatible test probes.
- CE requirement: Under the influence of RF field according to standard, the supplied test leads will pick up induced noise. To have better shielding effect, a short-twisted lead should be used.

## QUICK START



### WARNING

Read "SAFETY INFORMATION" before using this device.

1. Turn the function switch to select combined function for "V".
2. Press the "Dual" button momentarily to set frequency measuring on secondary display.
3. Connect the **INPUT** terminals by test leads to the source to be tested.

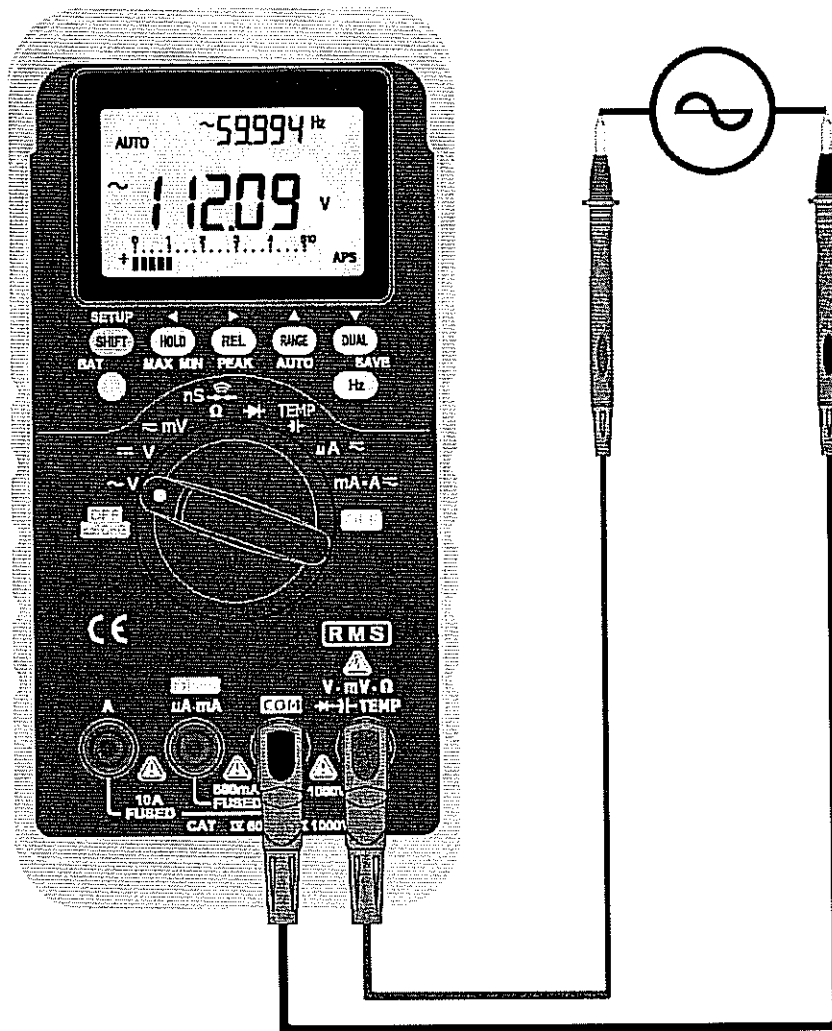

Figure- 1 Dual display for ACV/Hz Measurement

# MULTI-DISPLAY MULTIMETER

## ■ INTRODUCTION

The meter is robust for industrial fields and laboratories. The ambient temperature can be display with main measurement, which can help you to monitor the electrical value and record environment variation, simultaneously.

### Main Features:

- DCV, ACV, DCA, ACA, OHM, Diode check, Audible continuity, Temperature, Frequency, Duty cycle and Pulse Width tests
- AC+DC true RMS measurement for both voltage and current (model 2890A only)
- AC true RMS measurement for both voltage and current
- Ambient temperature display with main measurement
- Battery capacity indication
- Brightness LED backlight
- Resistance measurement up to 50M $\Omega$
- Conductance measurement from 0.01nS (100G $\Omega$ ) ~ 50nS
- Capacitance measurement up to 100mF.
- Frequency counter up to 20MHz
- The % scale readout for 4-20mA or 0-20mA measurement
- dBm with selectable reference impedance
- 1ms Peak hold to catch inrush voltage and current easily
- Temperature test with the selectable 0°C compensation (optional Temp adapter required)
- K type temperature with environment compensation selection (optional Temp adapter required)
- Frequency, Duty cycle and Pulse width measurements.
- Dynamic Recording for Min/Max/Average
- Data Hold with Manual or Auto Trigger and Relative modes
- Diode and Audible Continuity Test
- Bi-directional optic computer interface with SCPI commands
- Safe, precision and speed closed case calibration
- 50,000 count precision True-RMS digital multi-meter and designed to meet IEC-1010 CAT. III 1000V and CAT. IV 600V standards
- Built-in rechargeable battery
- Smart Charger design without battery removal (optional accessory)
-

# GETTING START WITH YOUR METER

## ■ Display Illustration

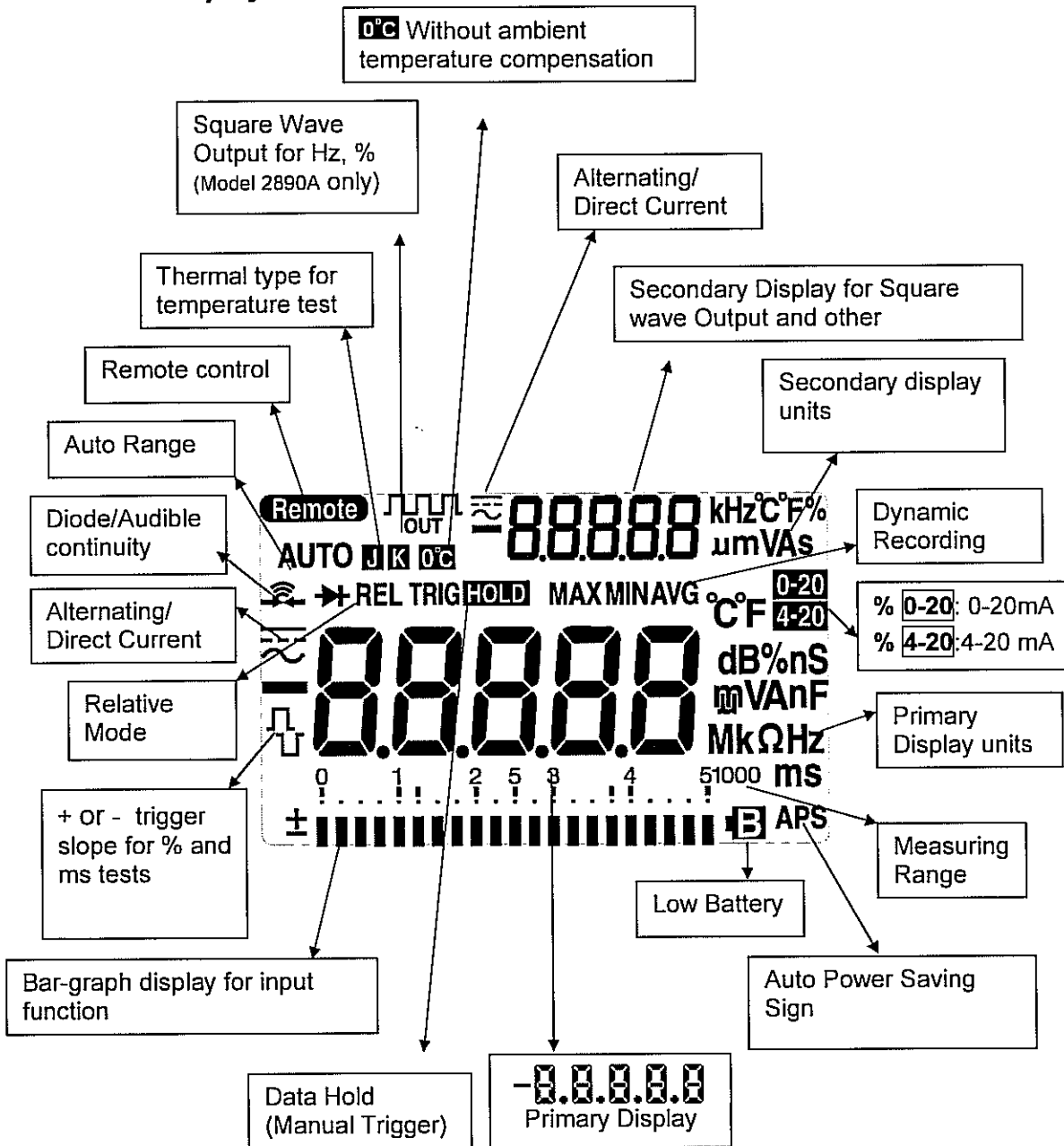

Figure- 2 LCD Display



## ■ Rotary Switch

**⚠ WARNING**

Be sure to remove the test leads from measuring source or target before changing rotary switch.

To turn this device ON and select a function you want by turning the rotary switch.

**Table- 2 Rotary Switch position**

Position	Function
1	
2	$\sim$ V
3	$\equiv$ V
4	$\sim$ mV
5	Resistance/ Continuity/ nS
6	$\rightarrow$ / Hz (FC) ( Hz model 2890A only)
7	$\rightarrow$ TEMP (TEMP requires optional adapter)
8	$\sim$ $\mu$ A
9	$\sim$ mA
	$\sim$ A
10	OFF

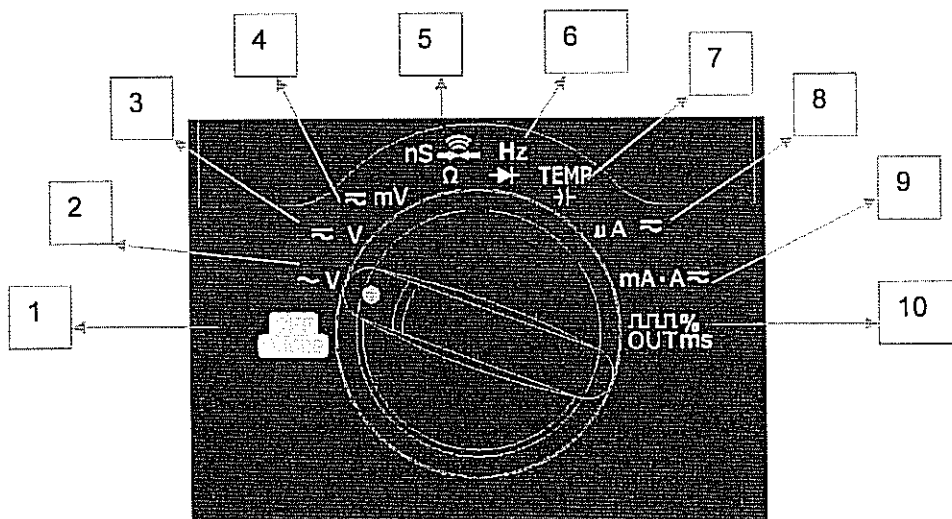

**Figure- 3 Rotary Switch for selecting function**

## ■ TERMINALS



To avoid damaging the meter, do not exceed the input limit as below table:

**Table- 3 Input limit specification**

ROTARY SWITCH FUNCTION	INPUT TERMINAL		OVERLOAD PROTECTION
~ V	V. Ω. →	COM	1000 V R.M.S.  1000V for the circuits <0.3A short circuit.
~ V			
~ mV			
Ω			
→  (Diode)			
Capacitance →			
Temperature			
~ μA	μA mA	COM	440mA/ 1000V 30kA fast-acting
~ mA			
~ A	A	COM	
OUT	OUT	COM	

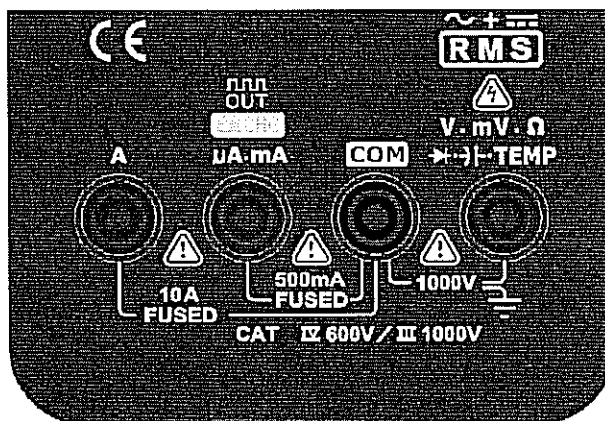

**Figure- 4 Terminals**

## ■ PUSH-BUTTON OPERATIONS

The operation of push-button is shown as below. When push the button, a related symbol will be lit, and the beeper will sound. Turning the rotary switch to another position will reset current operation of push buttons.

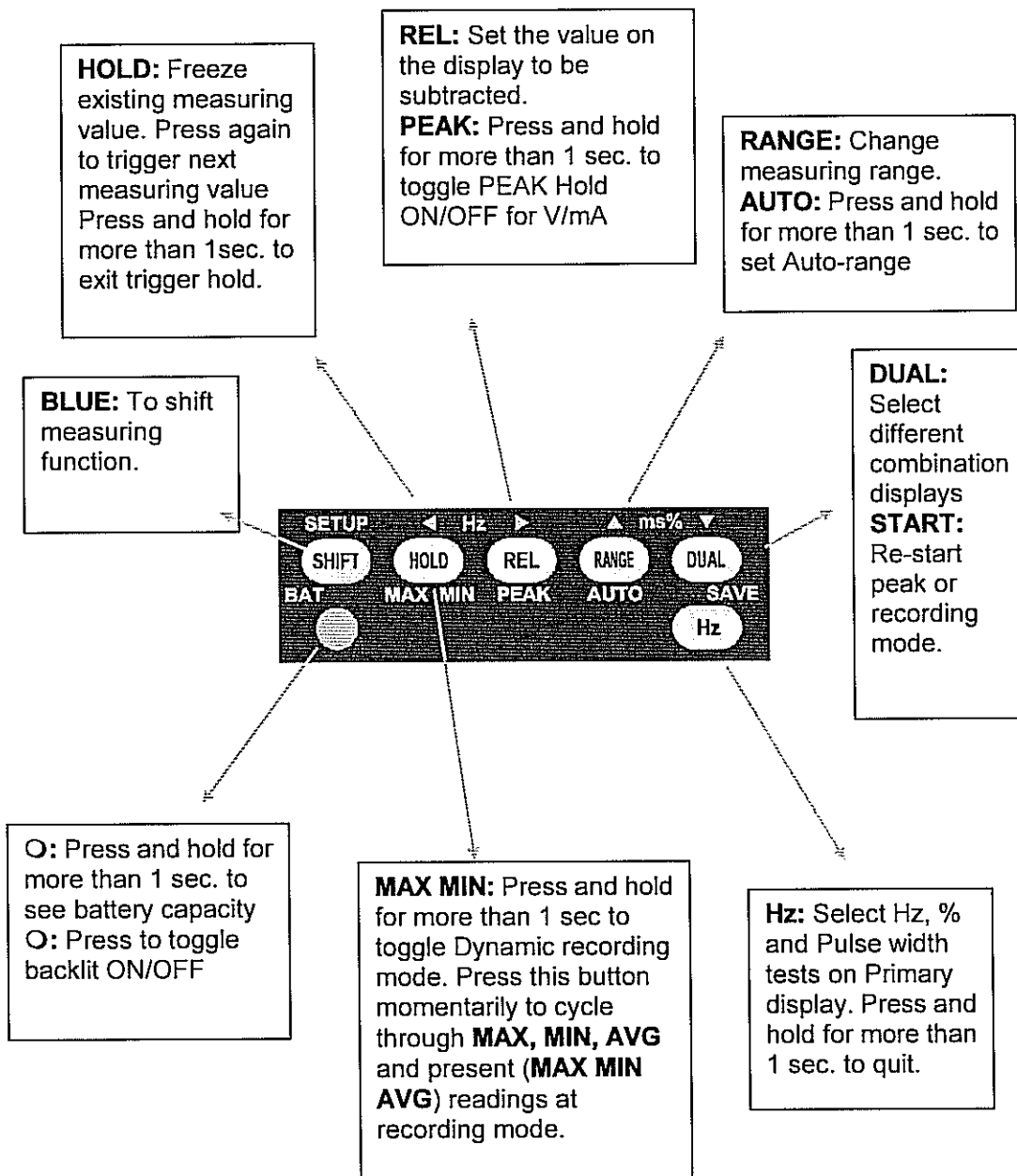

Figure- 5 Pushbuttons

1. **AC/ DC (BLUE):** Select Blue function
  - Push this button momentarily to step through DC, AC for mV measurement.
  - Push this button momentarily to step through DC, AC and % of mA for Current measurement.
  - For Ohm test, push this button momentarily to step through continuity "📶", nS and Auto ranging Ohm test.
  - For Duty cycle and Pulse width tests, press this button for more than 1 second to change the trigger slope + ( $\square$ ) or - ( $\sqcup$ ).
  - For  $\mu$  / TEMP measurement, press this button to select Capacitance test, ETC ON (environment temperature compensation) and **0°C** (non-ETC) temperature test.
  
2. **HOLD:** DATA HOLD (Trigger) or Refresh Data Hold (Auto trigger)
  - Press this button momentarily to hold the existing displayed digital value and waiting for trigger. The sign of **HOLD** will be indicated.
  - Press this button momentarily again to trigger another data hold. The sign of **TRIG** will be flashed before finished or updated measurement
  - Press this button for more than one second to exit trigger mode.
  - To select Refresh Hold by setup mode. The reading can be updated automatically when the reading is changed, and the beeper sounds a tone to remind user, simultaneously.
  
3. **HOLD (MAX • MIN):** Dynamic Recording
  - Record maximum, minimum, and calculates true average.
  - Press this button for more than 1 second to toggle recording mode on or off at continuous mode (non data hold).
  - Press this button momentarily to cycle through **MAX, MIN, AVG** and present (**MAX MIN AVG**) readings.
  - The beeper sounds when a new maximum or minimum value is recorded.
  - Press this button momentarily to cycle through **Peak +, Peak -** reading after setting peak mode. The screen shows "**HOLD MAX**" to indicate the PEAK + and show "**HOLD MIN**" to indicate the PEAK -.
  
4. **REL (ZERO):** Relative function
  - The relative function shows the difference between the measured value and the stored value.
  - Press to toggle **Relative (REL)** ON or OFF.
  - For Voltage and current measurements, press this button for more than 1 second to toggle 1 ms peak hold ON/OFF. The display will show "**HOLD MAX**" to indicate the PEAK + and show "**HOLD MIN**" to indicate the PEAK -.

## 5. RANGE:

- In auto-range, press this button to select manual range and turn off the sign of "AUTO".
- In manual range, press this button momentarily to step up 1 range at one time, press this button for more than 1 second to select auto-range.
- In auto-range, the " AUTO " is lit and the meter will select an appropriate range for resolution if a reading is greater than maximum available range, " OL "(overload) will be displayed on the display. The meter will select a lower range when reading is less than about 9% of full scale.
- Push this button momentarily to change measuring range and re-start the PEAK+ and PEAK- measurements after setting the peak mode.

## 6. DUAL: Dual Display Combination

- Press this button momentarily to select different combination displays. Detail combination displays, please refer to the chapter of **MULTI-DISPLAY MULTIMETER**.
- Push this button momentarily to re-start a new peak or recording mode after setting peak or recording mode.

## 7. Hz: Select Frequency, Duty Cycle and Pulse Width Tests

- For, Voltage or Current test, press this button momentarily to enter Frequency test and Voltage or Current will be indicated in secondary display. Press this button again to step through Frequency, Duty cycle, Pulse width test. Press this button for more than one second to come back voltage or current measurement.
- The combination displays by pushing "Hz" button, please refer to the chapter of **MULTI-DISPLAY MULTIMETER**.

## 8. O: BAT/ Back-lit

- Press this button for more than 1 second to see battery capacity. It will return to normal function automatically after 3 seconds.
- Press this button momentarily to toggle backlit ON or OFF. Backlit turns off automatically after setting period.

## POWER-ON OPTION

### ■ *How to enter setup mode*

Press and hold **SETUP (Blue)** button, then turn rotary switch to any on position form OFF. Release push button when you hear a tone, the meter will enter setup mode then. These parameters will be remained in non-versatile memory even the meter is turned off.

User can configure related parameters on setup mode by following procedures:

1. Press "▶ (LEFT)" or "► (RIGHT)" button to select which menu item to be set.
2. Press "▲ (UP)" or "▼ (DOWN)" button to change the parameter.
3. Press "BLUE" button to select which digit to be adjust, the selected digit will be flashed.
4. Push "SAVE" button momentarily to save your change.
5. Push "BLUE" button for more than one second to exit setup mode.

### ■ *Factory Default*

Following Table describes the outline of the setup menu item and indicates the factory settings.

**Table- 4 Descriptions for Outline of Setup Menu Item**

<b>Menu item</b>	<b>Factory Setting</b>	<b>Selectable Parameters</b>
<b>Baud Rate</b>	9600	2400, 4800, 9600, 19200
<b>Parity</b>	None	Odd, even or none
<b>Data bits</b>	8	8 bits or 7 bits (Stop bit is always 1 bit)
<b>ECHO</b>	OFF	ON or OFF
<b>Print</b>	OFF	ON or OFF
<b>Percentage scale</b>	4-20mA	4-20mA and 0-20mA for % scale readout
<b>Frequency</b>	0.5Hz	Set minimum measuring frequency, 0.5Hz, 1Hz, 2Hz or 5Hz.
<b>Beep</b>	2400	The driving frequency can be set for 2400, 1200, 600 or 300 Hz. "OFF" means to disable beep.
<b>Temperature unit</b>	°C	Four combinations can be selected: 1. °C only 2. °C/ °F can be selected. 3. °F only 4. °F/ °C can be selected.
<b>Refresh Hold</b>	OFF	OFF means Data Hold (Manual Trigger), set 100~1000 variation counts to enable refresh hold.
<b>Auto power off</b>	15	1~99 minutes, "OFF" means to disable auto power off.
<b>Backlit</b>	30	1~99 seconds, "OFF" means to disable turning off backlit automatically.
<b>Temperature type</b>	K	K type or J type
<b>decibel</b>	dBm	dBm or dBV
<b>Ref</b>	600Ω	Reference impedance for dBm display can be set from 1~9999Ω.
<b>EtEMP</b>	OFF	Enable (On)/ Disable (OFF) Environment temperature (EtEMP) to be displayed with main measurements.

Notes:

1. The temperature menu item will be selected by pushing "O" button for more than one second to enter temperature option.

## ■ *Baud Rate*

The baud rate is selected for remote control. It can be set to 2400, 4800, 9600 or 19200 Hz. To select your request as follows:

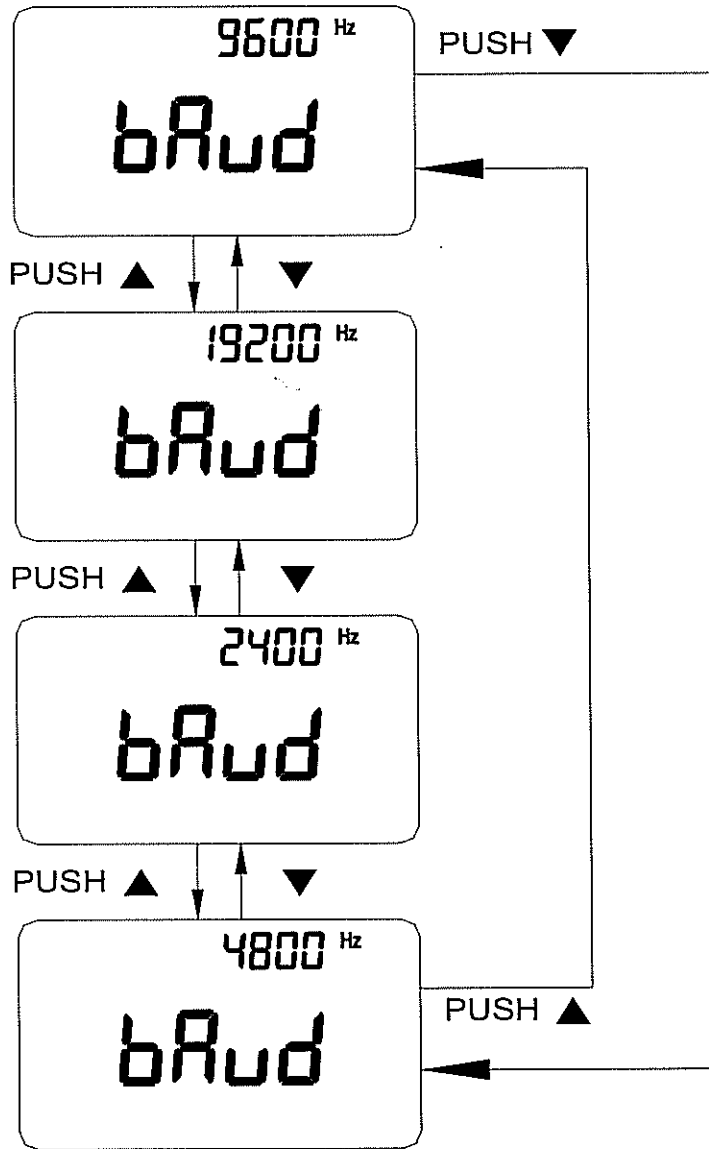

Figure- 6 Baud rate setup for remote control



### ■ Parity Check

The parity check is selected for remote control. It can be set to none, even or odd bit. To select the parity as follows:

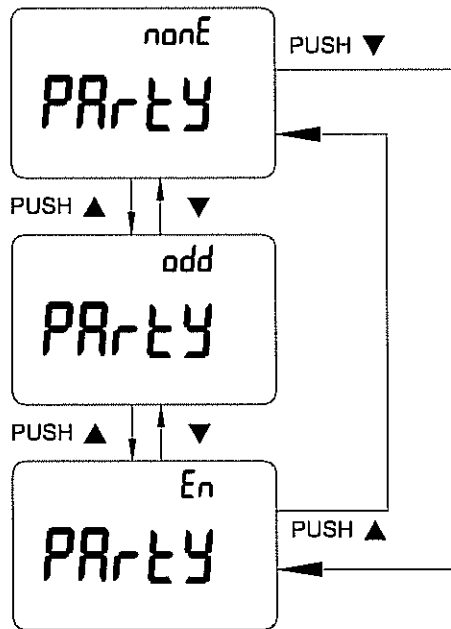

Figure- 7 Parity Check setup for remote control

### ■ Data Bit

The data bit is selected for remote control. It can be set to 8 or 7 bits. The stop bit is defined to 1 bit and can't be changed. To select the data bit as follows:

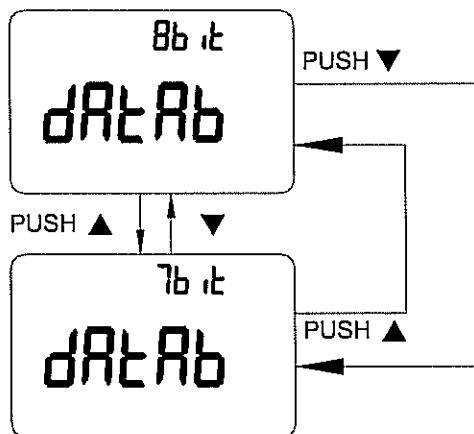

Figure- 8 Data bit setup for remote control

## ■ *Echo*

With ECHO ON, the meter echoes (returns) all the characters whatever it receives. To enable the Echo as follows:

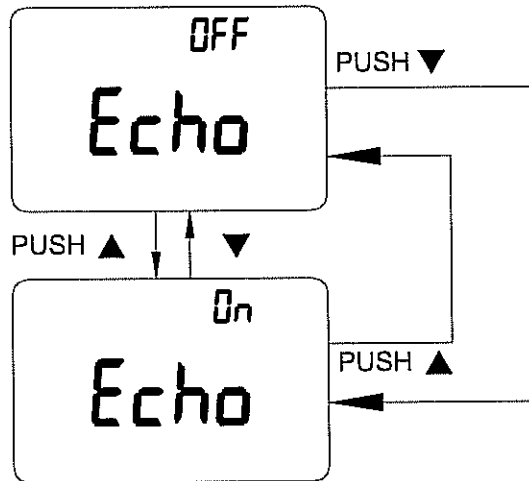

Figure- 9 ECHO Setup

## ■ *Print only*

If the remote interface of the meter is under Print-only mode, the meter will print out the measured data when the measuring cycle is completed. The meter will auto send the newest data to a host continuously. The meter doesn't accept any commands from the host under Print-Only enabled. The remote indicator of the meter will be flashed during operation as Print-only ON. To enable the print-only as follows:

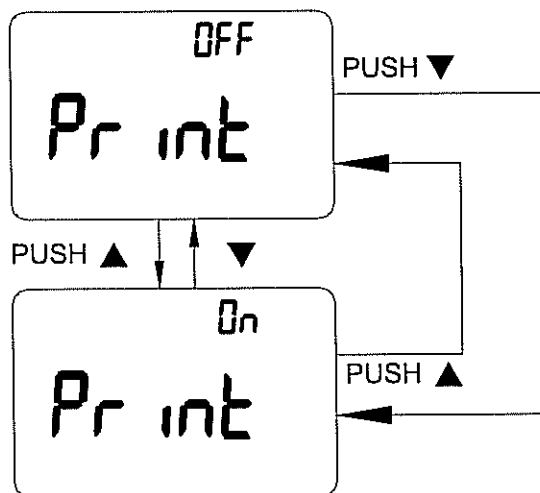
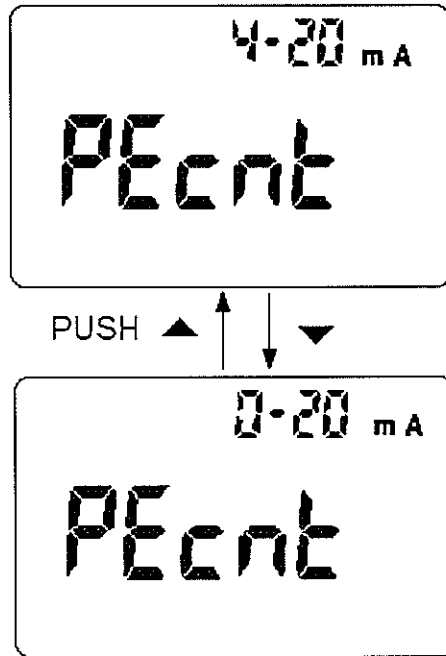

Figure- 10 Print-only Setup

■ **Percentage (%) scale for 4-20mA or 0-20mA measuring**

To set the DC current measuring display with % scale readout. Set 4-20mA or 0-20mA for proportional to 0%~100%. The 25% scale readout represents DC 8mA at 4-20mA, and DC 5mA at 0-20mA. To set % scale proportional as follows:



**Figure- 11 The % scale Setup for mA measuring.**

### ■ *Minimum Frequency measuring*

To set minimum measurement frequency, will influence the measuring rate for frequency, duty cycle, and pulse width measurement. Normally, the measuring rate defined at general specification is based on the minimum frequency is 1 Hz.

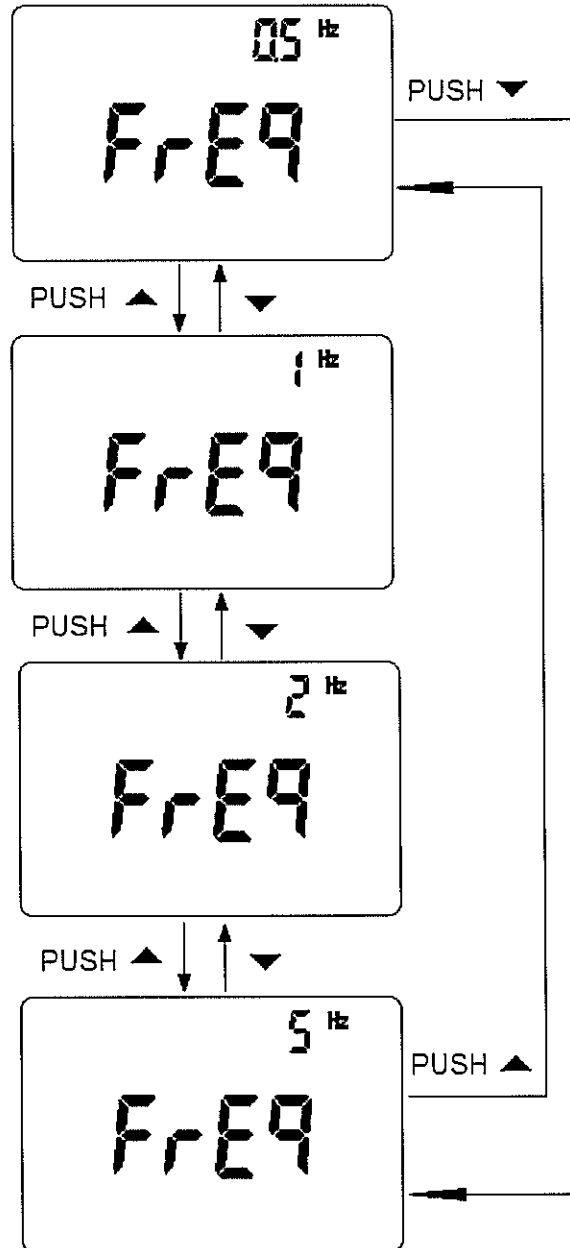

Figure- 12 Minimum Frequency Setup

### ■ Beep Frequency

The driving frequency can be set for 2400, 1200, 600 or 300 Hz. The beeper can be set to "OFF" as you want kept silent during operation, to select a tone you like according to follows:

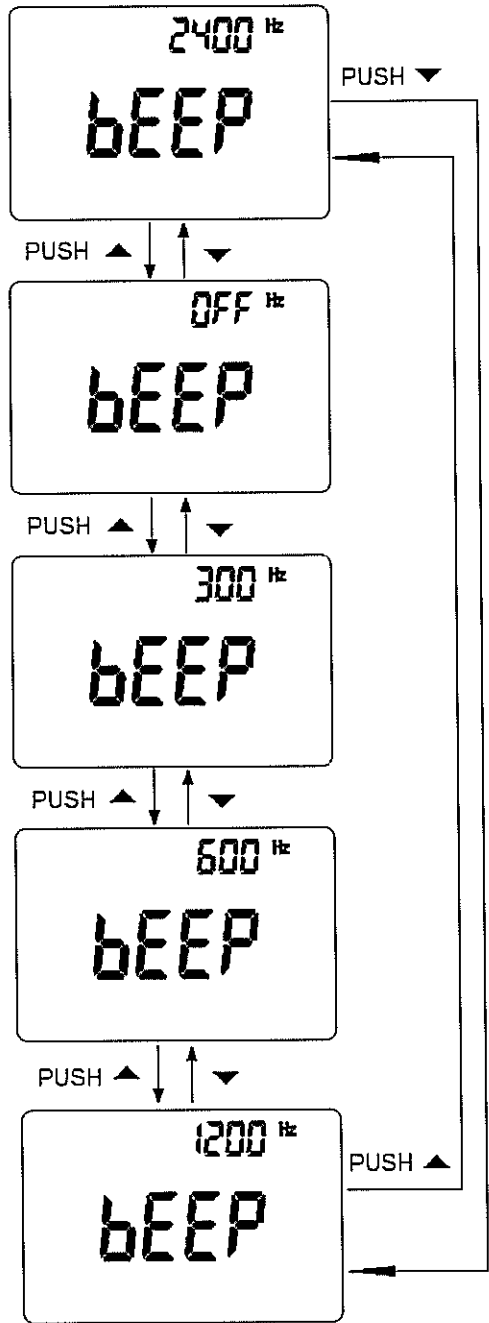

Figure- 13 Driving frequency of Beeper setup

■ **Temperature Unit (requires optional adapter)**

**⚠ CAUTION**  
**Always set the temperature unit display for official requirements and comply with National law.**

Normally, the temperature unit is different for various areas. To select an official required scale unit by setup mode. Four combination displays can be selected:

1. Celsius only ( $^{\circ}\text{C}$  on primary display)
2. Celsius/ Fahrenheit ( $^{\circ}\text{C}/^{\circ}\text{F}$ ) display can be switched by pushing DUAL button.
3. Fahrenheit only ( $^{\circ}\text{F}$  on primary display)
4. Fahrenheit / Celsius/ ( $^{\circ}\text{F}/^{\circ}\text{C}$ ) display can be switched by pushing DUAL button.

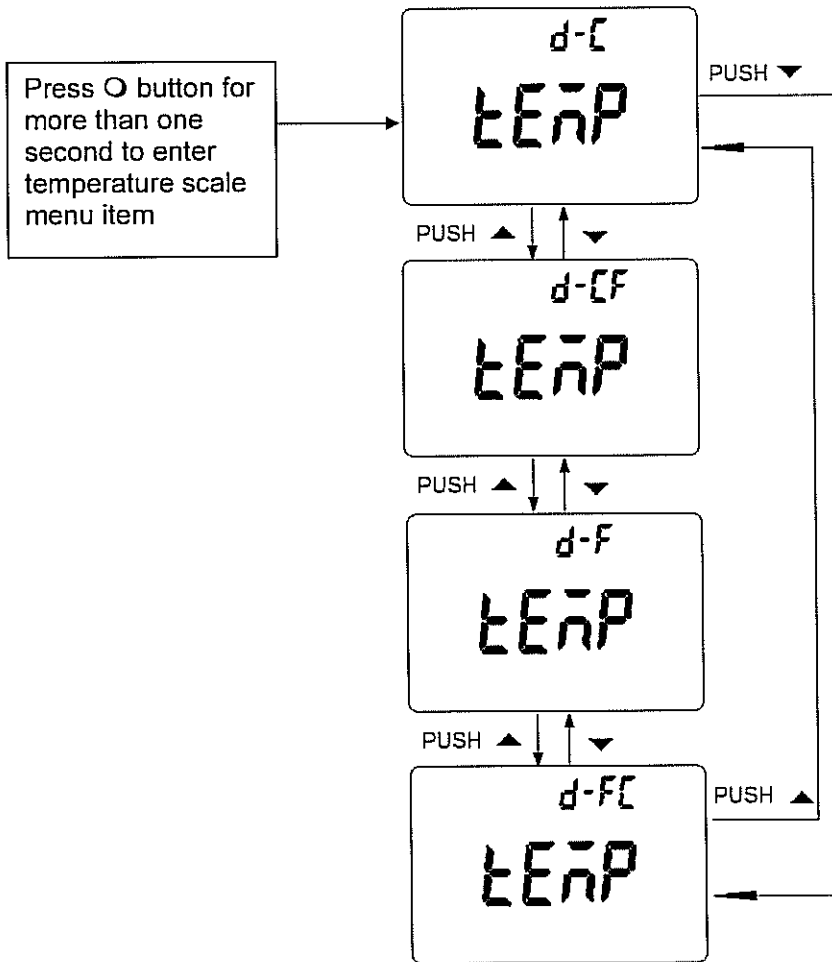

Figure- 14 Temperature Unit Setup

### ■ Data Hold/Refresh Hold

Normal, factory default the hold mode to Data Hold (Manual Trigger by key/ BUS trigger by remote control). Set "OFF" for Data Hold (Manual Trigger), and set 100~1000 variation counts to enable Refresh Hold. The variation of measuring value exceed the setting of variation count, the refresh hold will be ready to trigger. To enable refresh hold as follows:

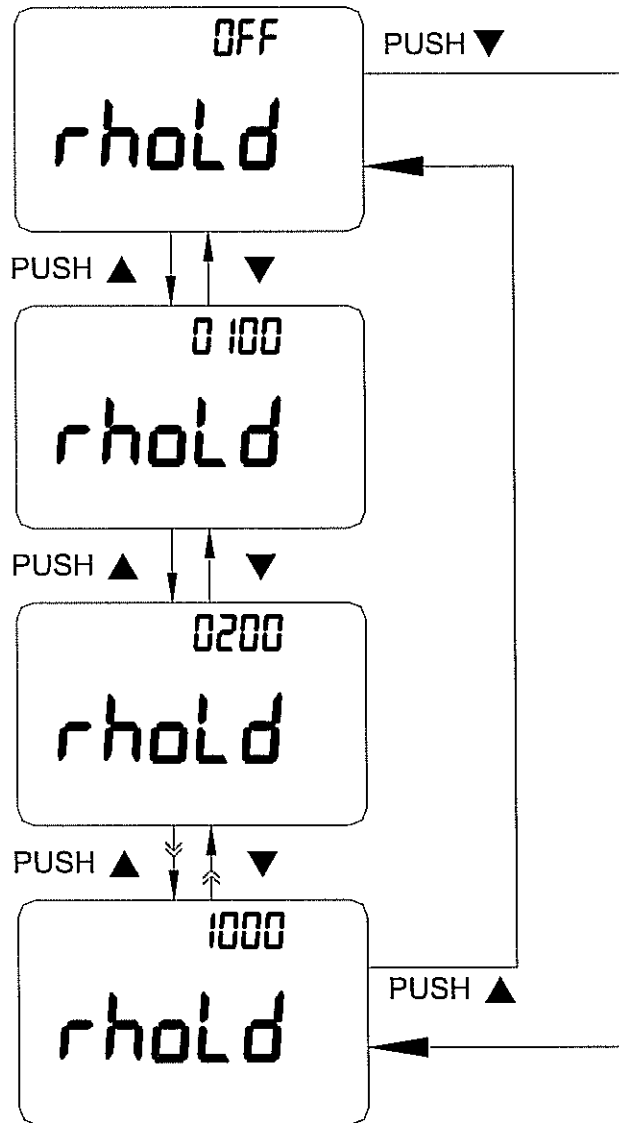
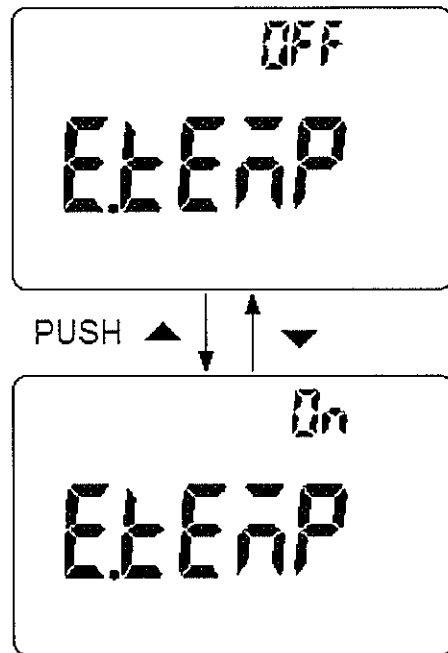

Figure- 15 Data Hold/ Refresh Hold Setup

## ■ **Environment temperature**

Normal, factory default the environment temperature to be disabled. To enable this test accompanies with other functions, will slight reduce the display updated rate. You can know environment temperature with main parameter measurement as enabled environment temperature measurement. To enable environment temperature as follows:



**Figure- 16 Enable Environment Temperature display**



## ■ Auto Power Saving

The timer for APS (Auto Power Saving) can be set to 1~99 minutes, "OFF" means to disable APS. To set timer of APS as follows:

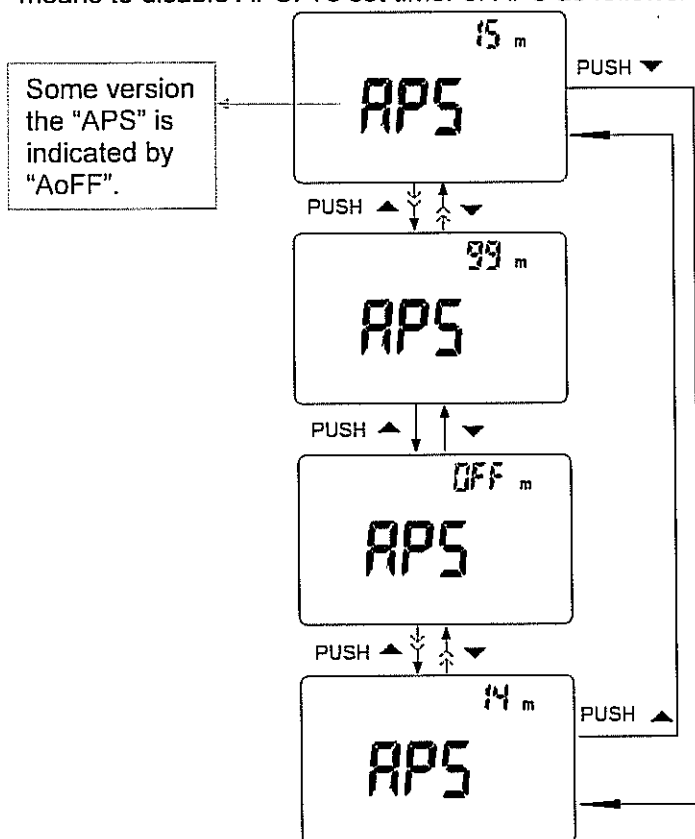

Figure- 17 Auto power saving setup

The instrument may automatic turn off within a setting period, if none of the following happens.

- Push buttons are used.
- Measurement function is changed.
- Dynamic recording is set.
- 1 ms peak hold is set.
- Auto power off has been disabled by Setup mode.

You can turn the rotary switch to the OFF position, then turn on again to activate the meter after auto power off, or push any button to wake up. Only DUAL, RANGE, REL and HOLD buttons can wake meter up when set on square wave output (square wave output only on model 2890A). When the meter is to be used for longer periods, you may disable the APS. The sign "APS" will be turned off when APS disabled. The meter will stay on continuously as the APS is disabled. To shut off the meter by turning the rotary switch to the off position.

■ **Thermocouple Types (For model 2890A only)**

The types of thermocouple sensor can be selected for J or K type. The default type is K type. To toggle the types as follows:

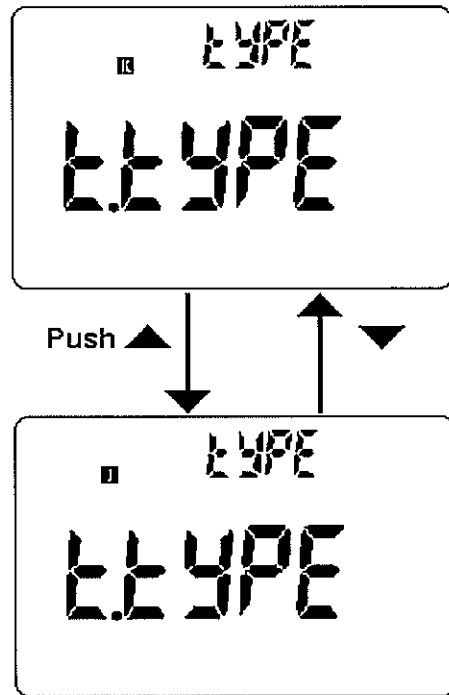

**Figure- 18 Thermocouple Types**

## ■ Backlit Display

The timer can be set to 1~99 seconds, "OFF" means to disable turning off backlight automatically. The backlight will be turned off automatically after a setting period. To set the period as follows:

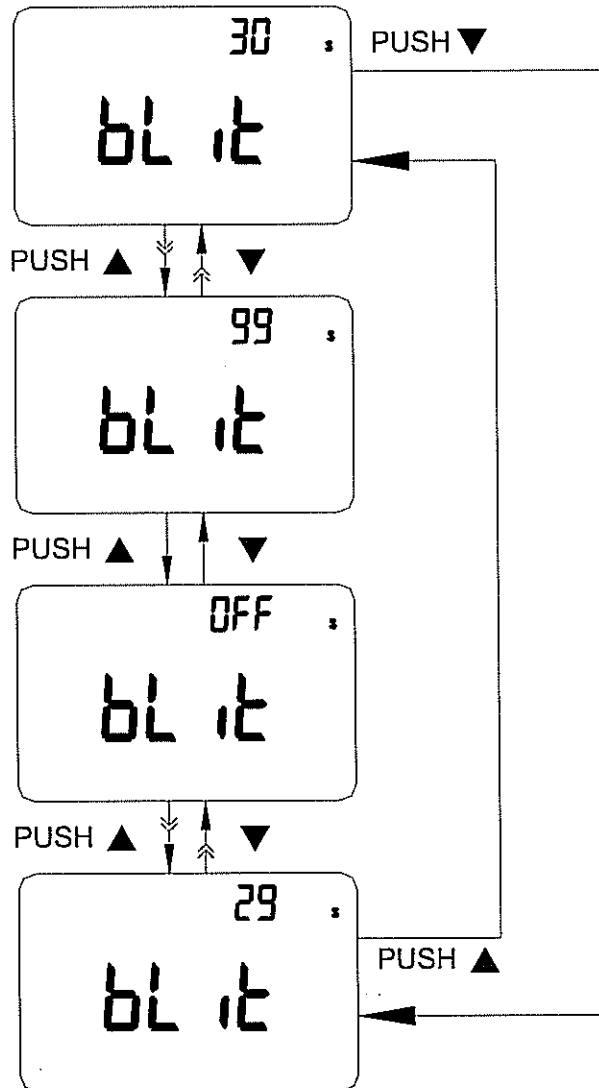
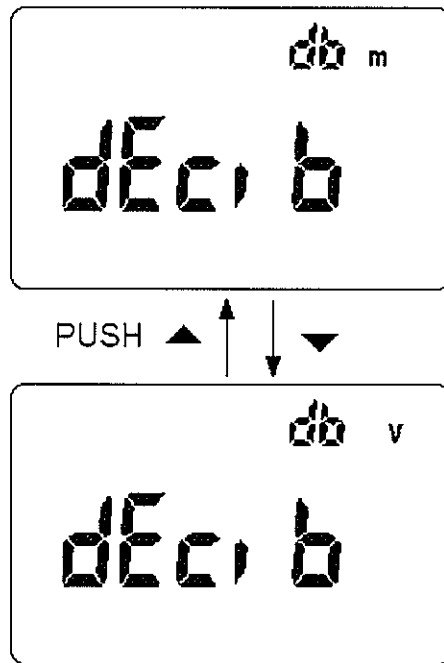

Figure- 19 Backlit Timer Setup

## ■ *Decibel Types*

The Decibel test can be selected for dBV or dBm. To toggle the types as follows:



**Figure- 20 Decibel Types**

■ **Reference impedance for dBm**

The reference impedance can be set from 1 to 9999 $\Omega$ , the default value is 600 $\Omega$ . To set the reference impedance as follows:

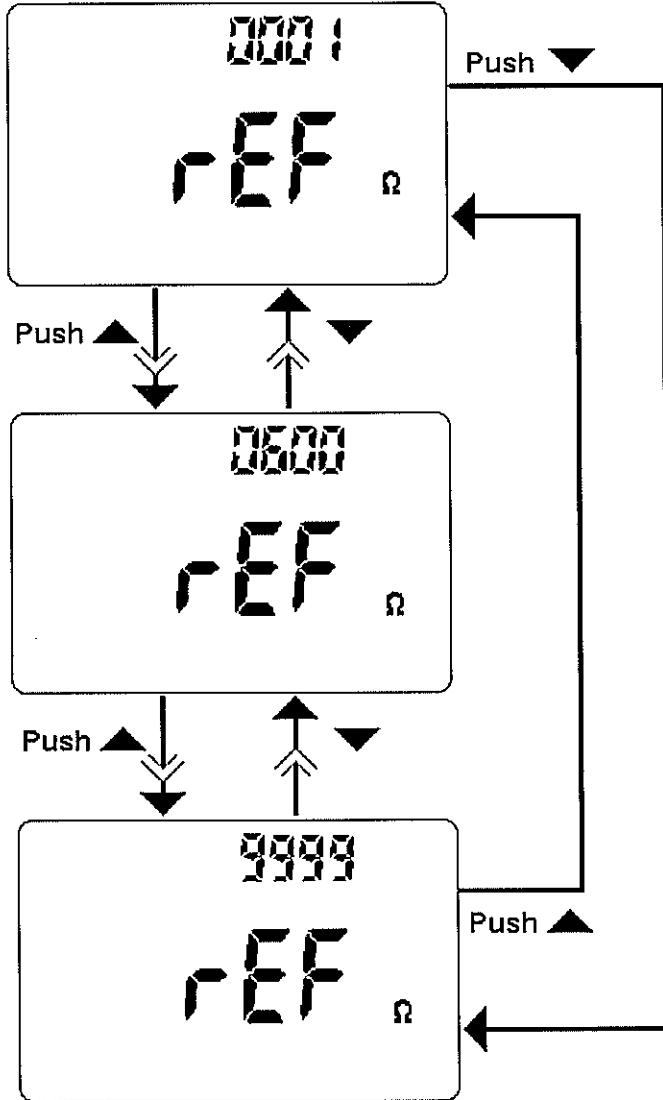

Figure- 21 Reference Impedance for dBm

■ **Reset to Default**

Push SAVE button for more than one second to reset the optional value to factory default. The setup mode will be set to Baud Rate menu item automatically after finished reset.

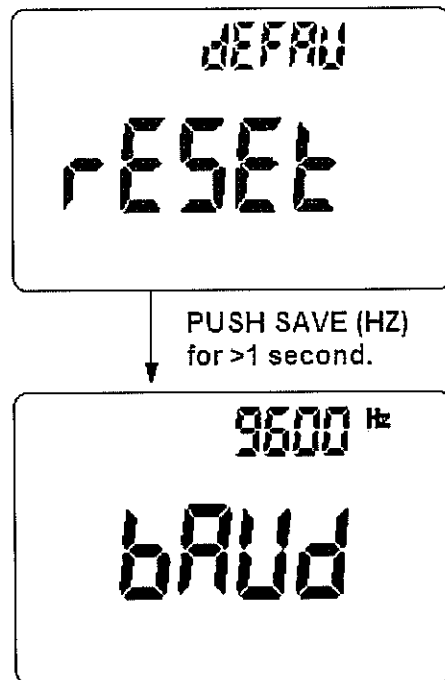

Figure- 22 Reset to default





## BARGRAPH

The analog bar-graph likes the needle on an analog meter, but without the overshoot. The bar-graph updates are faster than the digital display. That is quite useful for making peak and null adjustments and observing rapidly changing inputs.

The bar-graph would not be used for frequency, duty cycle, pulse width, 4-20mA % scale, 0-20mA % scale and temperature measurements. When the frequency, duty cycle and pulse width is indicated on primary display for voltage or current measurement, the bar-graph is presented for voltage or current value. When 4-20mA % scale or 0-20mA % scale is indicated on primary display, the bar-graph is presented for current value.

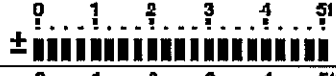
The "+" or "-" sign will be indicated when the positive or negative value has been measured or calculated, respectively. Each segment is presented for 25000 or 500 counts depended on the range value indicated on peak bar-graph. See below table:

**Table- 5 Bar-graph Counts**

Range	Counts/ segment	Used for the function
	25000	V, A, Ω, Diode
	25000	V, A, Ω
	25000	V, A, Ω, nS
	500	V, A, $\rightarrow$
	500	$\rightarrow$
	500	$\rightarrow$

## A FREE-FOR-ALL APPLICATION FUNCTION

### ■ SQUARE WAVE OUTPUT (For model 2890A only)

Square wave output which a unique function for unimaginable applications, for instances, PWM (Pulse Width Modulation) output, Adjustable Voltage Control, Synchronic clock (baud rate generator) etc. Also you can use to check and calibrate flow-meter displays, counters, tachometers, oscilloscopes, frequency converter, frequency transmitter and other frequency input devices. That is a free-for-all application function.

Square wave output can set parameters for frequency and duty cycle.

#### 1. How to select the square wave output function.

1. Turn the rotary switch to the  $\square$  output position.
2. The square wave output has 2 parameters can be set. Initial setting is frequency **150 Hz** and duty cycle **50.000 %**, respectively.

#### 2. The 28 frequencies can be selected, please refer below table:

Frequency
0.5, 1, 2, 5, 10, 15, 20, 25, 30, 40, 50, 60, 75, 80, 100, 120, 150, 200, 240, 300, 400, 480, 600, 800, 1200, 1600, 2400, 4800 Hz

To adjust the frequency according to following procedures:

- a. Press "**▶ (LEFT)**" or "**▶ (RIGHT)**" button to select frequency cycling. The frequency will be indicated on primary display.
- b. Press **Hz** button will be same as "**▶ (RIGHT)**" button.

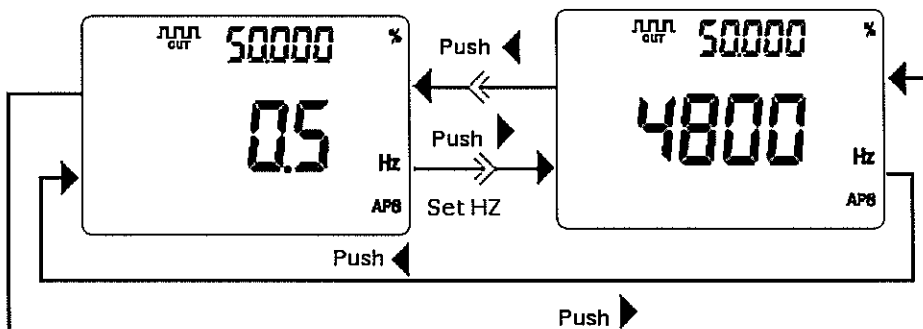

Figure- 23 Frequency Adjustment for Square wave

#### 3. Duty cycle adjustment

To adjust the duty cycle in accordance with following procedures:



- a. Press "BLUE" button to select duty cycle display on secondary display.
- b. Press "▲" or "▼" button to adjust the duty cycle. The duty cycle can be set for 256 steps and each step is 0.390625%. The display only indicates the best resolution with 0.001%.

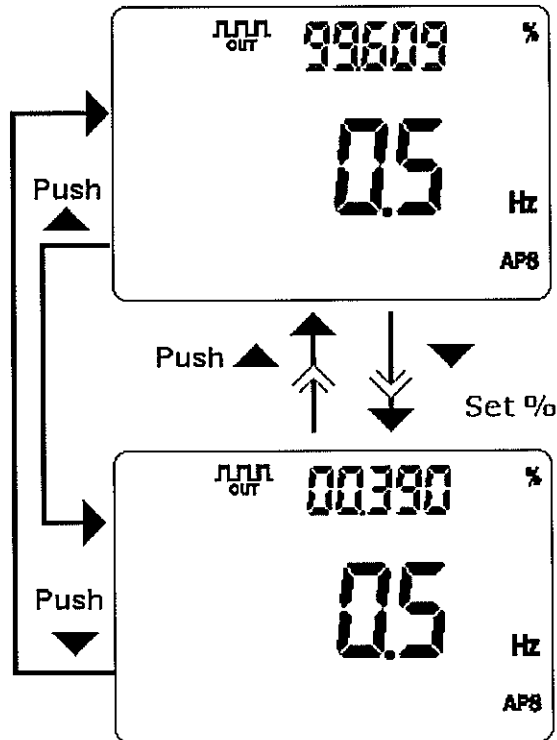

Figure- 24 Duty Cycle adjustment for Square Wave

#### 4. Pulse width adjustment

To adjust the Pulse width in accordance with following procedures:

- a. Press "BLUE" button to select pulse width display on secondary display.
- b. Press "▲" or "▼" button to adjust the pulse width. The pulse width can be set for 256 steps and each step is  $1 / (256 \times \text{frequency})$ . The display range will be adjusted automatically for the ranges of 9.9999~9999.9 ms.

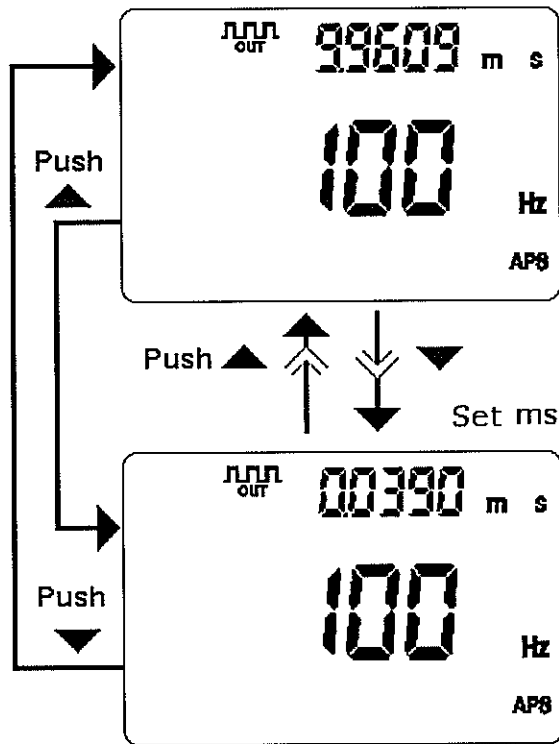
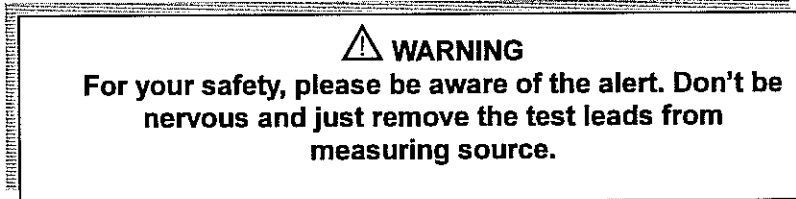

Figure- 25 Pulse width adjustment for Square Wave

## ALERTING

### ■ OVERLOAD ALERT FOR VOLTAGE MEASUREMENT



This meter provides an overload alert for voltage measurement during auto-ranging mode or manual range can recognize 1010V. The beeper sounds tones periodically once the measuring voltage is exceeded alerting voltage of 1010.0V. For your safety, please be aware of this alert.

### ■ INPUT WARNING

The meter sounds alerting beep when the test lead inserted to "A" terminal but rotary switch didn't set mA/A function. The primary display will indicate "Error" and flash until the test lead removed from "A" terminal.

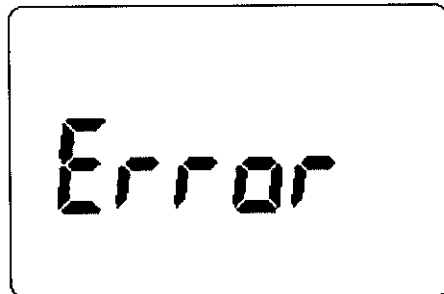
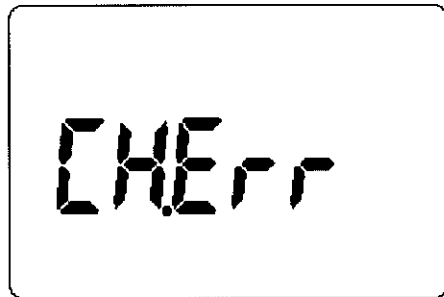

Figure- 26 Input Warning

## ■ **Charge Terminal ALERT**

The meter sounds alerting beep when the "CHARGE" terminal detected a voltage level more than 3~5V and the rotary switch didn't set to "VOLT" position. The meter sounds alerting beep and primary display indicates and flashes "CH.Err" until the lead removed from "CHARGE" terminal. For  $\mu\text{A}/\text{mA}$  measurement and square wave output would not recognize this alert.



**Figure- 27 Charge Terminal Alert**

## Capacity check of battery

This meter has provided battery capacity check. Press the button of "BAT O" for more than one second to see battery capacity. It will return to normal function indication automatically after 3 seconds. See following figure:

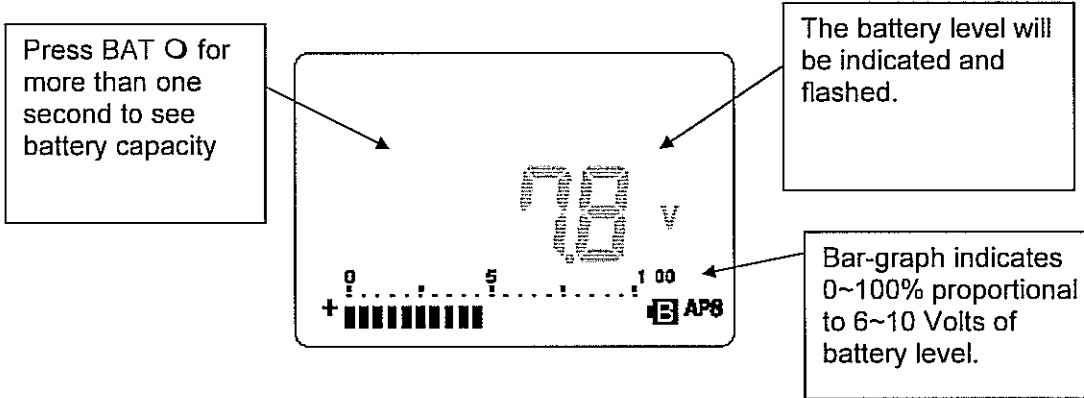

**Figure-28 Capacity check of battery**

The primary display will indicate existing battery capacity, and the battery level is flashing. The bar-graph is indicated the capacity by percentage for proportional the voltage from 6.0V~10.0V.

Battery Voltage	Proportional Percentage
6.0V~10.0V	0%~100%

## CALCULATION FUNCTION

This device provides operators with various functions including:

- Dynamic Recording**
- Data Hold**
- Trigger Hold**
- Refresh Hold**
- Relative (Zero)**
- Decibel display**
- Peak Hold**

### ■ **DYNAMIC RECORDING**

The dynamic recording mode can be used to catch intermittent turn on or turn off surges, verify performance, measure while you are away, or take readings while you are operating the equipment under test and can't watch the meter.

The average reading is useful for smoothing out unstable or changing inputs, estimating the percentage of time a circuit is operated, or verifying circuit performance.

The elapsed time will be indicated on secondary display. The maximum time is 99999 seconds. Over the maximum time, an OL will be presented.

The operational procedures are described below:

1. Press "**MAX • MIN**" for more than 1 second to enter the dynamic recording at continuous mode (non data hold or trigger mode). The present value is stored to memories of maximum, minimum and average, also the **MAX MIN AVG** sign will be lit.
2. Press "**MAX • MIN**" button for more than 1 second to exit recording mode.
3. Press "**MAX • MIN**" button momentarily to cycle through maximum, minimum, average and present readings as recording mode enabled. The **MAX, MIN, AVG** or **MAX MIN AVG** sign will be lit respectively to indicate which value is being displayed. See following **Figure**.
4. Press DUAL (START) button to re-start recording mode.
5. The beeper sounds when a new maximum or minimum value is recorded.
6. If an overload is recorded the averaging function will stop. The average value becomes "**OL**" (overload).
7. The auto power saving feature will be disabled and the "**APS**" will be turned off at recording mode.
8. Selecting dynamic recording in auto range, it will record the value of MAX, MIN or AVG for different ranges.
9. The recording speed of dynamic recording in manual range is about 0.067 seconds approx.
10. The average value is the true average of all measured values taken since the recording mode was entered.

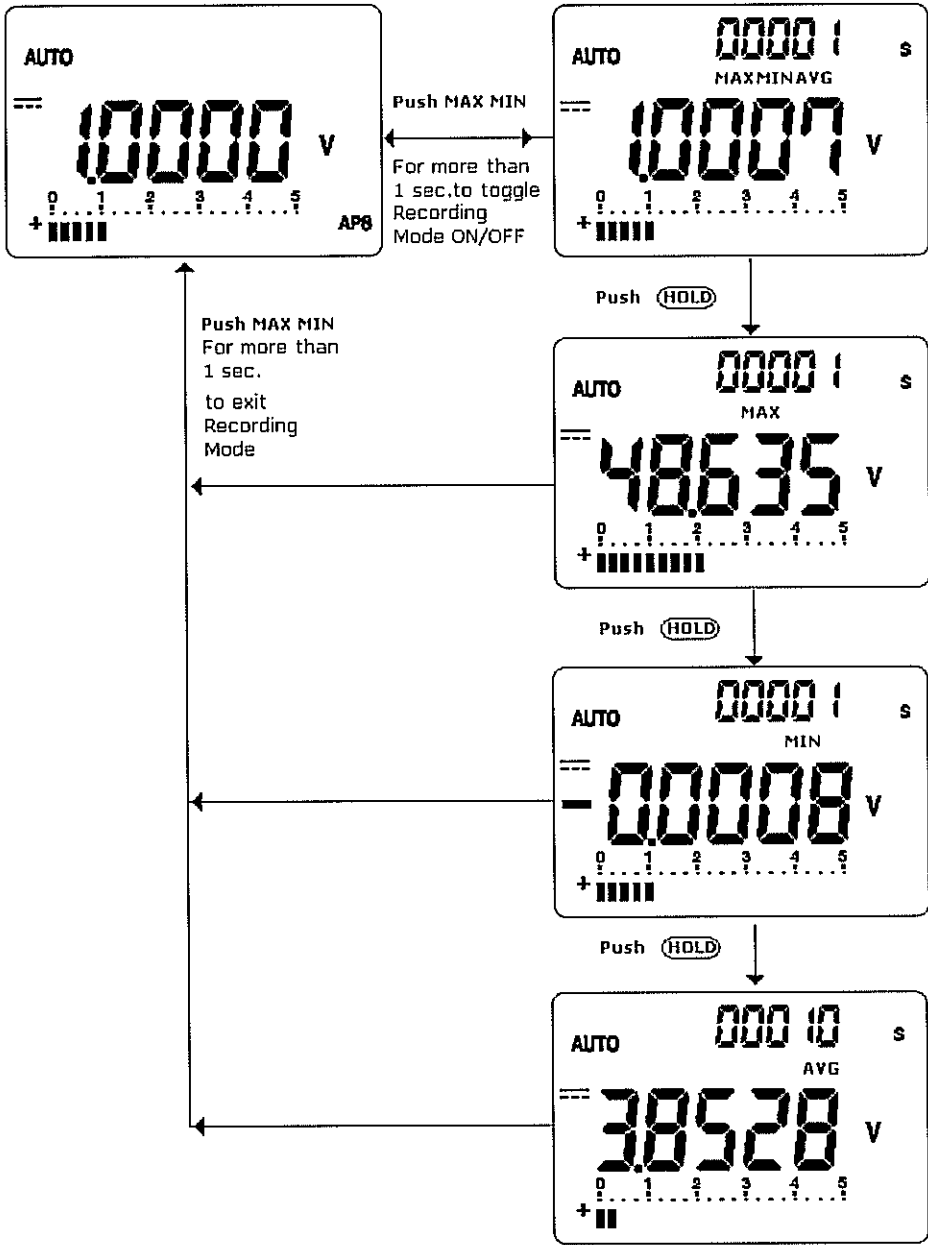

Figure- 29 Display of Dynamic Recording

## ■ DATA HOLD

The data hold function allows operators to hold the displayed digital value. The bar-graph didn't be held, still proportional to real measurement value. Press **HOLD** button to freeze the displayed value, and the sign of **HOLD** will be displayed.

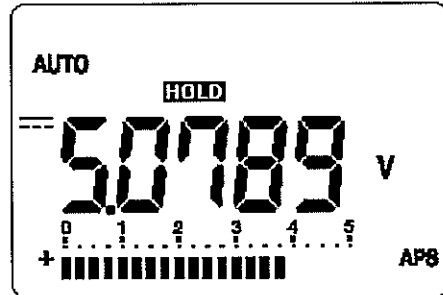

Figure- 30 Data Hold Operation

Press **HOLD** button for more than one second to exit this mode.

## ■ TRIGGER HOLD

Press **HOLD** button to freeze the displayed value and enter the manual trigger mode, and the sign of **HOLD** will be displayed. Press the button again to trigger another new measuring value updated to display. The sign of **TRIG** will be flashed before the new updates. Press **HOLD** button for more than one second to exit this mode.

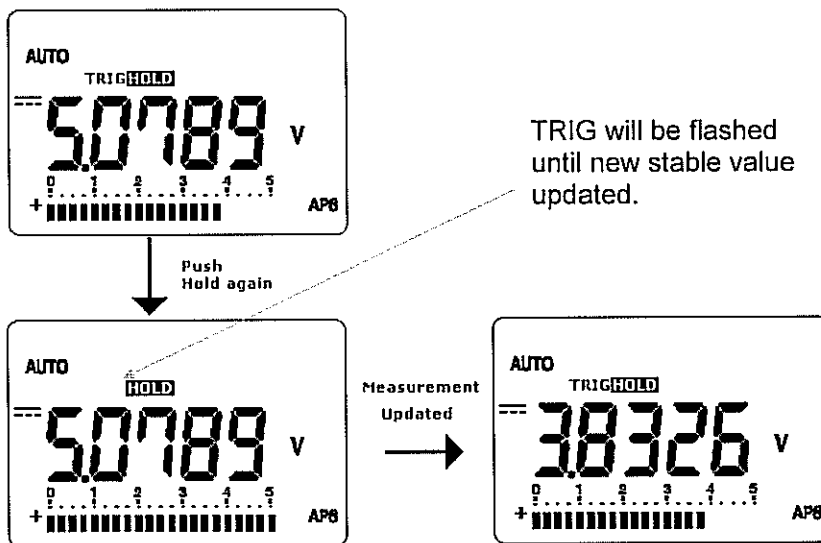

Figure- 31 Trigger Hold



## ■ REFRESH HOLD

You can use the setup mode to enable the **Refresh Hold** when you are working on a difficult measuring field. This function will auto trigger or update HOLD value with new measuring value, and sound a tone to remind user. The operation of push-button is same as the operations of Data hold.

Press "HOLD" button to enter Refresh Hold mode. The present value will be held, and the sign of **HOLD** will be lit. It will be ready to hold new measuring value once the variation of measuring value exceed the setting of variation count, and the sign of **HOLD** will be flashed. The hold value will be updated until the measuring value is stable, then stop flash and light **HOLD** and sound a tone to remind user.

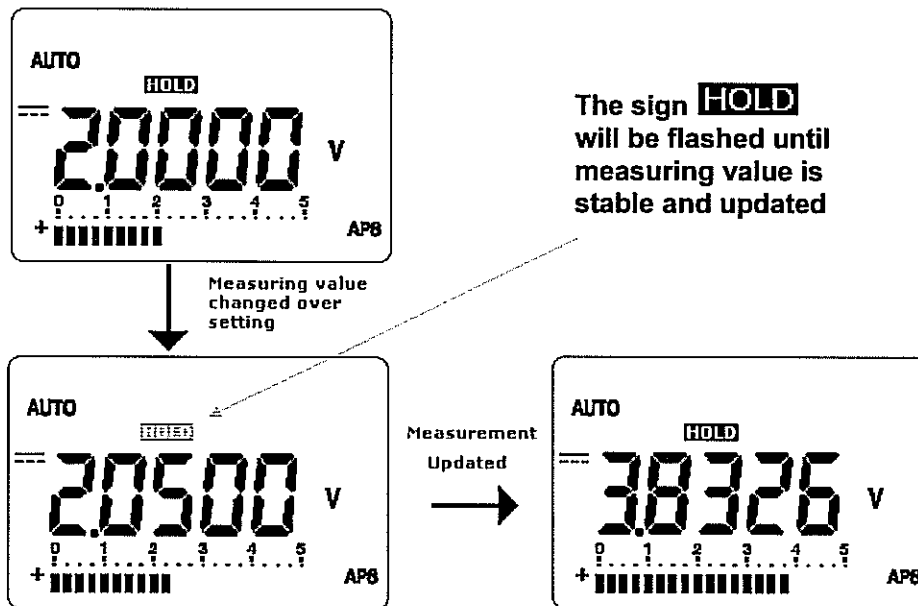

Figure- 32 Refresh Hold

For voltage and current measurements, the holding value will not be updated when the reading below 500 counts of minimum range.

Function	Range	Limit Value
DCV	5V~1000V	±0.0500V
DCmV	50mV~1000mV	±00.500mV
ACV	5V~1000V	0.0500V
ACmV	50mV~1000mV	00.500mV
DCμA	500μA~5000μA	±005.00μA
DCmA	50mA~500mA	±00.500mA
DCA	5A~10A	±0.0500A
ACμA	500μA~5000μA	005.00μA
ACmA	50mA~500mA	00.500mA
ACA	5A~10A	0.0500A

For resistance and diode measurements, the holding value will not be updated if the reading at "OL" or open state. The holding value may not be updated once the reading can't reach stable state for all measurements.

### ■ **RELATIVE (ZERO)**

The relative function subtracts a stored value from the present measurement and displays the result.

1. Press **REL** button momentarily to set the relative mode. This sets the display to zero and stores the displayed reading as a reference value and the sign of **REL** will be displayed.
2. The relative mode can be set at auto or manual range, but can't be set when an overload has occurred.
3. Press this button again to exit the relative mode.
4. When the Ohm measurement mode is entered, the display will reads a non-zero value due to the presence of test leads. You can use the relative function to Zero-Adjust the display.
5. For DC voltage measurement, the thermal effect will influence the accuracy. Use relative function to zero the thermal effect. Short the test leads, press REL button momentarily as the display value is stable.

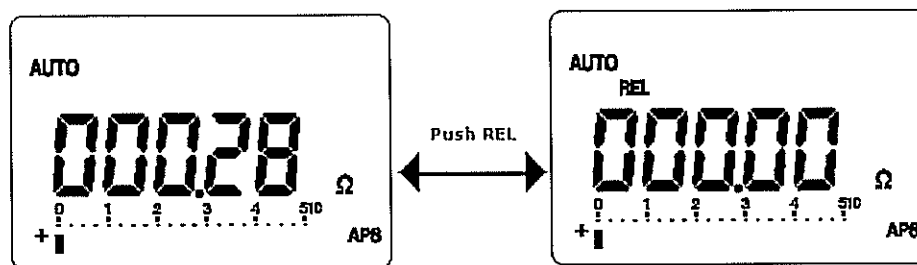

Figure- 33 Relative (Zero) Operation

## ■ Decibel display

The dBm operation calculates the power delivered to a reference resistance to 1 milliwatt, and can be applied to Vdc, Vac and Vdc+Vac measurements for decibel conversion. Voltage measurement is converted to dBm by using the following formula:

$$\text{dBm} = 10 \times \log_{10} [1000 \times (\text{measuring value})^2 / \text{reference impedance}]$$

Deleted: )

Push **SHIFT** button momentarily to toggle the dBm display on the primary display on AC voltage measurement. The bar-graph will be indicated AC voltage. The dBm display can be selected by push DUAL button. Only different is the AC voltage measurement will be indicated on secondary display. The reference resistance may be selected from 1~9999Ω by setup mode. The default value for reference resistance is 600Ω. See the following figure:

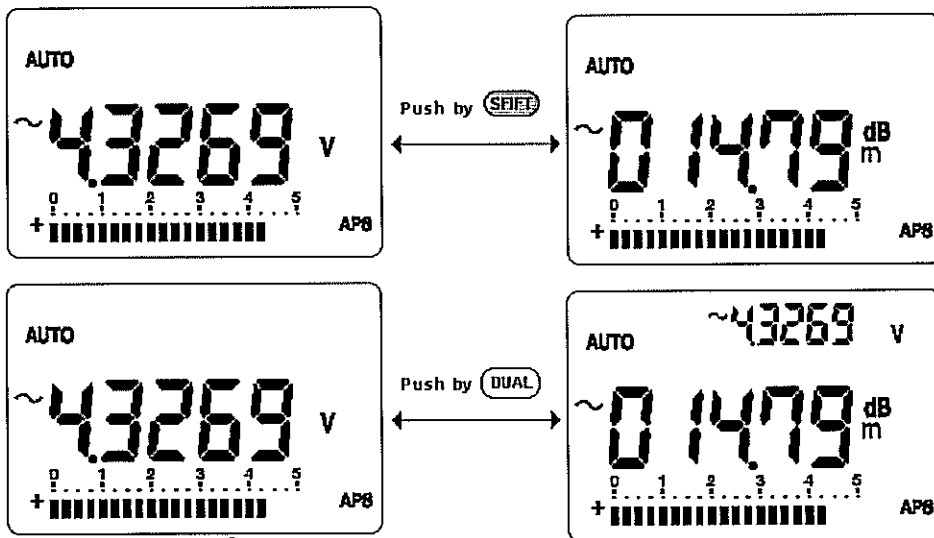

Figure- 34 dBm display

The decibel of voltage is calculated for above or below 1V. It can be selected by setup mode. It will be another temporary way to toggle dBV and dBm display by pushing **SHIFT** button for more than one second as dB selected.

The formula is according to voltage measurement as below:

$$\text{dBV} = 20 \log_{10} V_{in}$$

Push **SHIFT** button momentarily to toggle the dBV display on the primary display on AC voltage measurement. The bar-graph will be indicated AC voltage. The dBV display can be selected by push DUAL button. Only different is the AC voltage measurement will be indicated on secondary display. See the following figure:

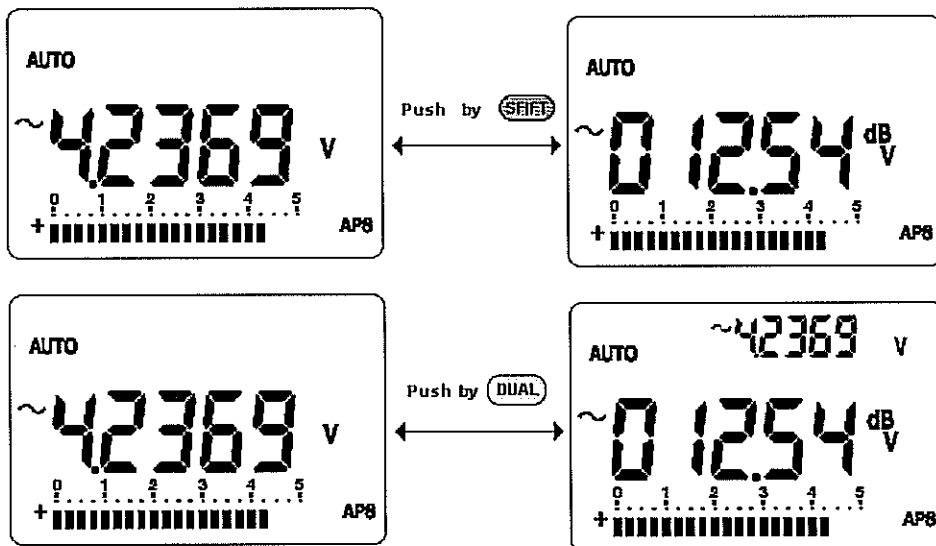

Figure- 35 dBV display

## ■ **Peak Hold**

You can use this Meter to analyze components such as power distribution transformers and power factor correction capacitors. The additional features allow the measurement of the half-cycle peak voltage by using the peak hold feature. This allows the determination of the crest factor:

$$\text{Crest factor} = \text{Peak value/True RMS value}$$

1. Press **PEAK** button for more than 1 second to toggle peak hold mode ON/OFF.
2. Press **HOLD (MAX• MIN)** button momentarily to show peak + or peak - value after setting the peak mode. The display shows **HOLD MAX** to indicate the PEAK + and shows **HOLD MIN** to indicate the PEAK -. See following **Figure**.
3. If the reading is "OL", then you can push **RANGE** button momentarily to change measuring range and re-start the PEAK measurement after setting the peak mode.
4. Press **DUAL (START)** button momentarily to re-start the peak hold again after setting peak mode.
5. According above measurement, the crest Factor will be  $153.81 / 108.78 = 1.414$ .

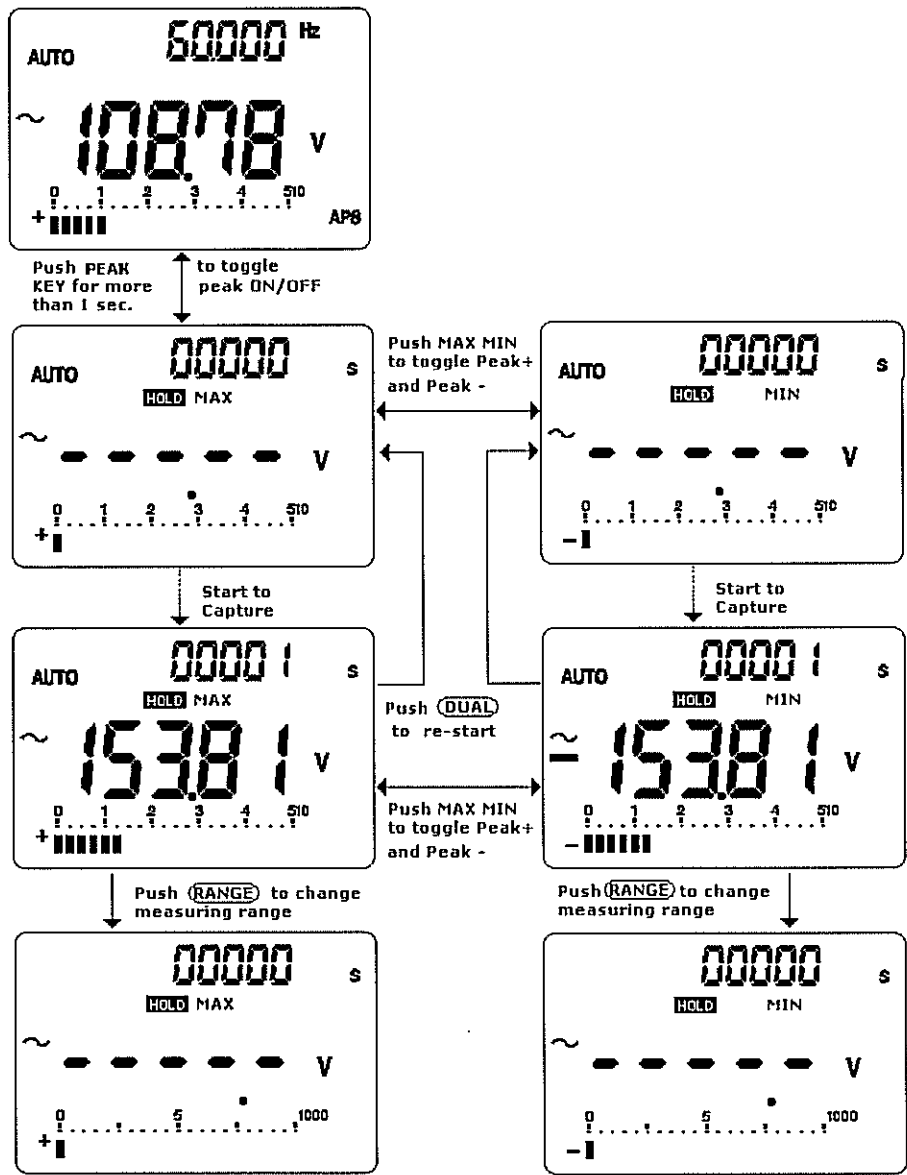

Figure- 36 Peak Hold Display

## REMOTE COMMUNICATION

This instrument has a bi-directional (full duplex) communication capability. This function will assist user to record and keep data easily. The protocol is provided by SCPI commands (Standard Commands for Programmable Instruments). You can simply use your familiar language to design what application software you want. All commands are combined by ASCII character, non-hexadecimal, which is much user friendly providing. Just configure the measuring range, and then get the measuring value. The detail SCPI for remote operation is accompanied with another file on the CD-ROM. Please refer to.

An optional accessory includes an optical USB-RS232 cable and a CD-ROM for PC application software. See [www.bkprecision.com](http://www.bkprecision.com)

Please refer following procedures if you want to communicate with personal computer:

1. Setup the communication parameters for the meter and the personal computer you used. The meter is default to (9600, n, 8, 1).
2. Be sure that the driver for USB and RS-232 transfer has been installed on your computer.
3. Fixes optic side of cable to communication port of meter, Be sure the text side to be face up. See following Figure.
4. The carrying case can be used as a stand. You can use short belt to buckle the cover.
5. Plug the other end of USB terminal of cable into USB port of personal computer. See following **Figure**.

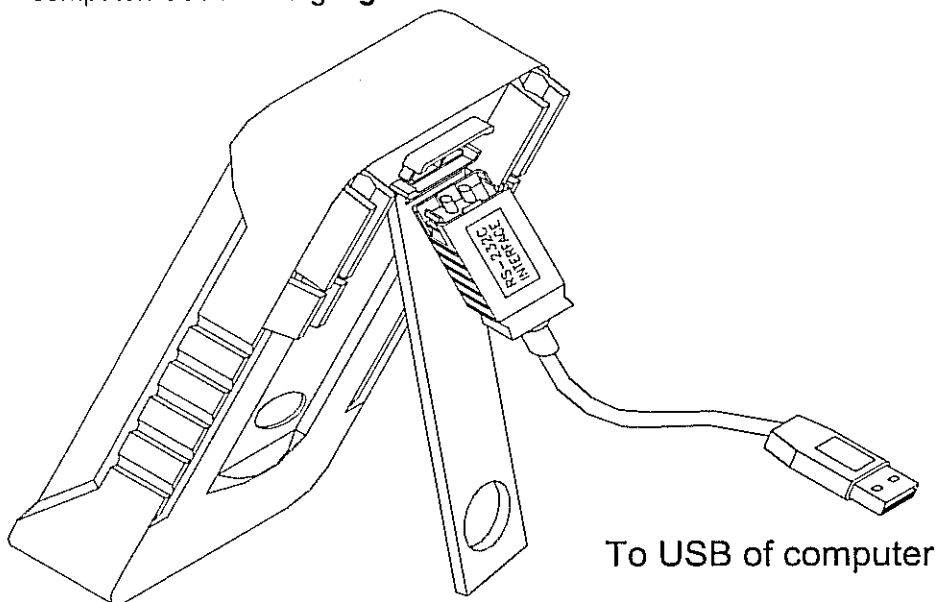

**Figure- 37 Cable Connection for Communication**

6. Execute the software to take the data as your needs.
7. Always press second snap slightly to remove the cable from communication port of the meter. See the snap as below picture.



Always press second snap slightly to remove the cable from communication port of the meter.

8. We don't suggest you to remove the cover of USB-RS-232 cable. But sometime, you may press snap deeply and pull the cable to cause the cover to be moved out as following picture. To assemble the cover as contrary direction you moved out. Be sure the text side on the cover at same side of inside TOP case. You will hear a click as the cover has been fixed

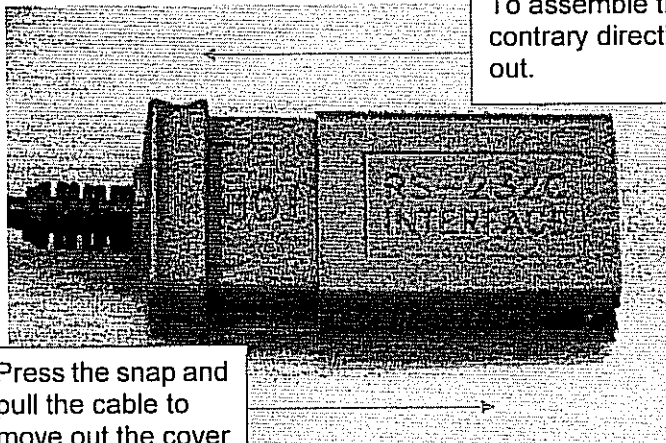

To assemble the cover as contrary direction you moved out.

Press the snap and pull the cable to move out the cover



## MULTI-DISPLAY MULTIMETER

The frequency measuring helps detect the presence of harmonic currents in neutral conductors and determines whether these neutral currents are the result of unbalanced phases or non-linear loads.

### ■ Selection by Hz Button

For Voltage or Current test, press **Hz** button momentarily to enter Frequency test. Voltage or Current will be displayed on the secondary display, the frequency will display on the primary display. The bar-graph still used to display voltage or current value. Press this button again to step through Frequency, Duty cycle and pulse width tests. This allows simultaneously monitor the present levels and frequency (or Duty Cycle, or pulse width).

Press **Hz** button for more than 1 second to return to Voltage or Current measurement.

Function	Primary display	Secondary display
AC Voltage	Frequency (Hz)	ACV
	Duty Cycle (%)	ACV
	Pulse Width (ms)	ACV
DC Voltage	Frequency (Hz)	DCV
	Duty Cycle (%)	DCV
	Pulse Width (ms)	DCV
AC+DC Voltage	Frequency (Hz)	AC+DC V
	Duty Cycle (%)	AC+DC V
	Pulse Width (ms)	AC+DC V
AC Current	Frequency (Hz)	ACA
	Duty Cycle (%)	ACA
	Pulse Width (ms)	ACA
DC Current	Frequency (Hz)	DCA
	Duty Cycle (%)	DCA
	Pulse Width (ms)	DCA
AC+DC Current (Model 2890A only)	Frequency (Hz)	AC+DC A
	Duty Cycle (%)	AC+DC A
	Pulse Width (ms)	AC+DC A
Frequency Counter (Model 2890A only)	Frequency (Hz)	- 1 -
	Duty Cycle (%)	- 1 -
	Pulse Width (ms)	- 1 -
Frequency Counter (Model 2890A only)	Frequency (Hz)	- 100 -

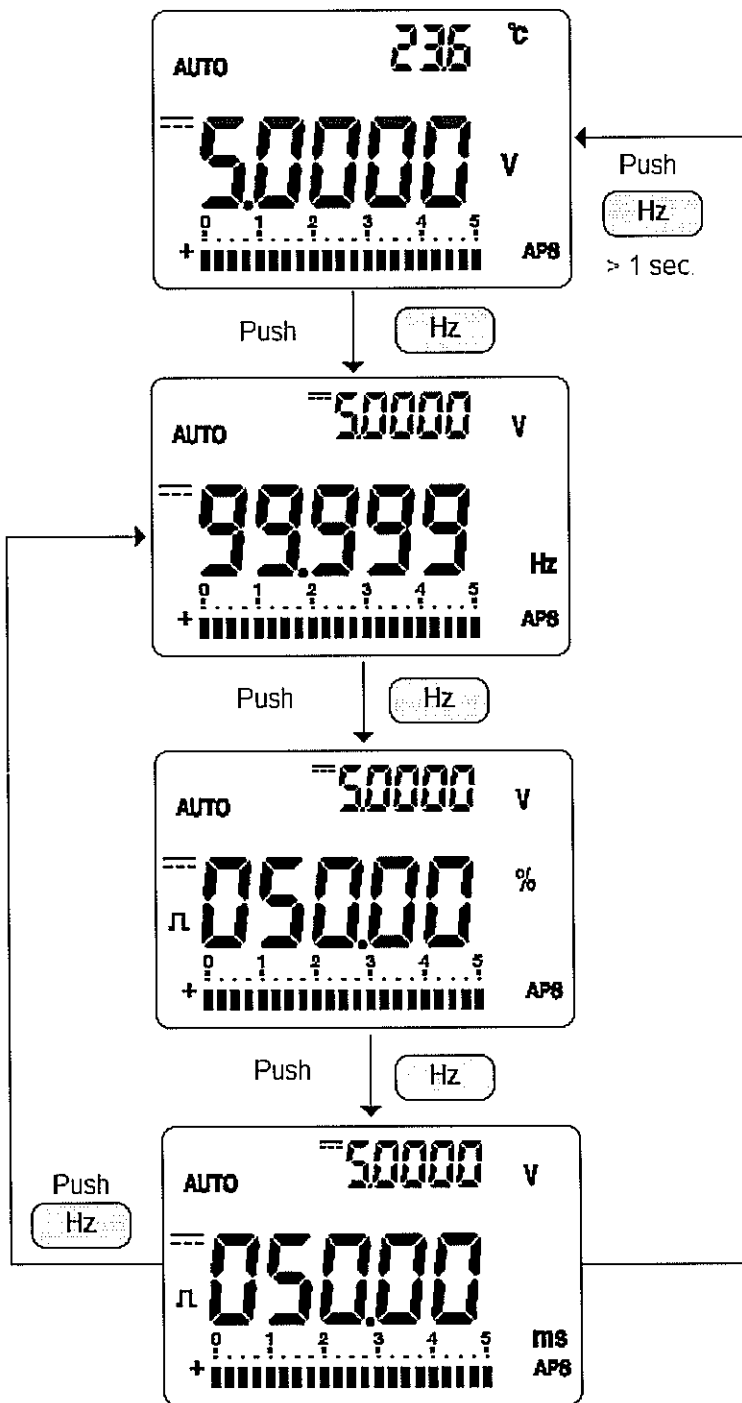







Figure- 38 Selecting by Hz button

■ **Selection by DUAL button (For model 2890A)**

It is another way to have combination display. Press DUAL button momentarily to select different combinations of dual display. The DUAL button will be disabled as Recording mode or TRIG mode enabled. The combinations of dual display are shown as following table.

Function	Primary display	Secondary display
$\sim V$	ACV	Hz (AC coupling)
	dBm or dBV	ACV
	ACV	Blank or Ambient Temperature
$\approx V$	ACV	Hz (AC coupling)
	dBm or dBV	ACV
	ACV	DCV
	ACV	Blank or Ambient Temperature
$\approx V$	DCV	Hz (DC coupling)
	dBm or dBV	DCV
	DCV	ACV
	DCV	Blank or Ambient Temperature
$\approx V$	AC+DC V	Hz (AC coupling)
	dBm or dBV	AC+DC V
	AC+DC V	ACV
	AC+DC V	DCV
	AC+DC V	Blank or Ambient Temperature
$\approx \mu A$	DC $\mu A$	Hz (DC coupling)
	DC $\mu A$	AC $\mu A$
	DC $\mu A$	Blank or Ambient Temperature
$\approx \mu A$	AC $\mu A$	Hz (AC coupling)
	AC $\mu A$	DC $\mu A$
	AC $\mu A$	Blank or Ambient Temperature
$\approx \mu A$	AC+DC $\mu A$	Hz (AC coupling)
	AC+DC $\mu A$	AC $\mu A$
	AC+DC $\mu A$	DC $\mu A$
	AC+DC $\mu A$	Blank or Ambient Temperature

Function	Primary display	Secondary display
	DCmA	Hz (DC coupling)
	DCmA	ACmA
	%(0-20 or 4-20)	DCmA
	DCmA	Blank or Ambient Temperature
	ACmA	Hz (AC coupling)
	ACmA	DCmA
	ACmA	Blank or Ambient Temperature
	AC+DCmA	Hz (AC coupling)
	AC+DCmA	ACmA
	AC+DCmA	DCmA
	AC+DCmA	Blank or Ambient Temperature
	DCA	Hz (DC coupling)
	DCA	ACA
	DCA	Blank or Ambient Temperature
	ACA	Hz (AC coupling)
	ACA	DCA
	ACA	Blank or Ambient Temperature
	AC+DCA	Hz (AC coupling)
	AC+DCA	ACA
	AC+DCA	DCA
	AC+DCA	Blank or Ambient Temperature
<b>Temperature</b>	Celsius (°C)	Ambient Temperature
	Fahrenheit (°F)	Ambient Temperature.

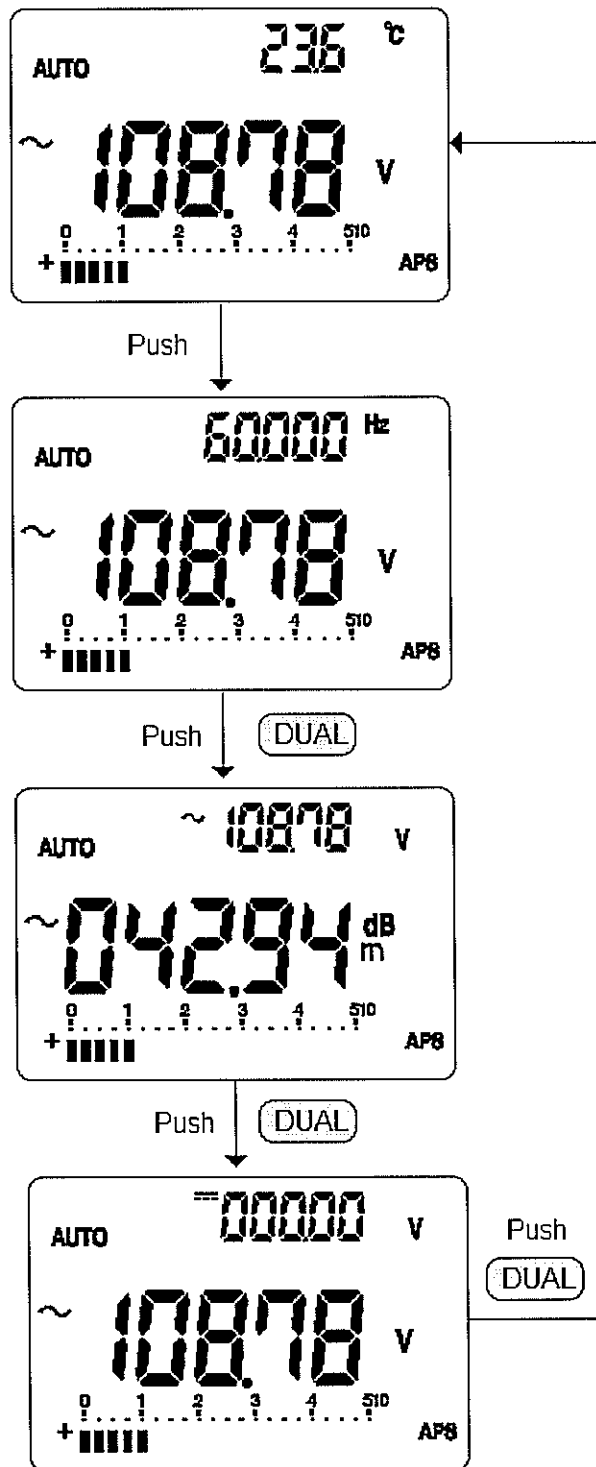



Figure- 39 Selecting by Dual button

■ **Selection by DUAL button (For model 2880B)**

It is another way to have combination display. Press DUAL button momentarily to select different combinations of dual display. The DUAL button will be disabled as Recording mode or TRIG mode enabled. The combinations of dual display are shown as following table.

Function	Primary display	Secondary display
$\sim$ V	ACV	Hz (AC coupling)
	dBm or dBV	ACV
	ACV	Blank or Ambient Temperature
$\equiv$ V	DCV	Hz (DC coupling)
	dBm or dBV	DCV
	DCV	Blank or Ambient Temperature
$\sim$ mV	DCmV	Hz (DC coupling)
	dBm or dBV	DCmV
	DCmV	ACmV
	DCmV	Blank or Ambient Temperature
$\sim$ mV	ACm V	Hz (AC coupling)
	dBm or dBV	ACmV
	ACmV	DCmV
	ACmV	Blank or Ambient Temperature
$\sim$ $\mu$ A	DC $\mu$ A	Hz (DC coupling)
	DC $\mu$ A	AC $\mu$ A
	DC $\mu$ A	Blank or Ambient Temperature
$\sim$ $\mu$ A	AC $\mu$ A	Hz (AC coupling)
	AC $\mu$ A	DC $\mu$ A
	AC $\mu$ A	Blank or Ambient Temperature
$\sim$ mA	DCmA	Hz (DC coupling)
	DCmA	ACmA
	%(0-20 or 4-20)	DCmA
	DCmA	Blank or Ambient Temperature
$\sim$ mA	ACmA	Hz (AC coupling)
	ACmA	DCmA
	ACmA	Blank or Ambient Temperature
$\sim$ A	DCA	Hz (DC coupling)
	DCA	ACA
	DCA	Blank or Ambient Temperature

Function	Primary display	Secondary display
 A	ACA	Hz (AC coupling)
	ACA	DCA
	ACA	Blank or Ambient Temperature
Temperature	Celsius (°C)	Ambient Temperature
	Fahrenheit (°F)	Ambient Temperature.

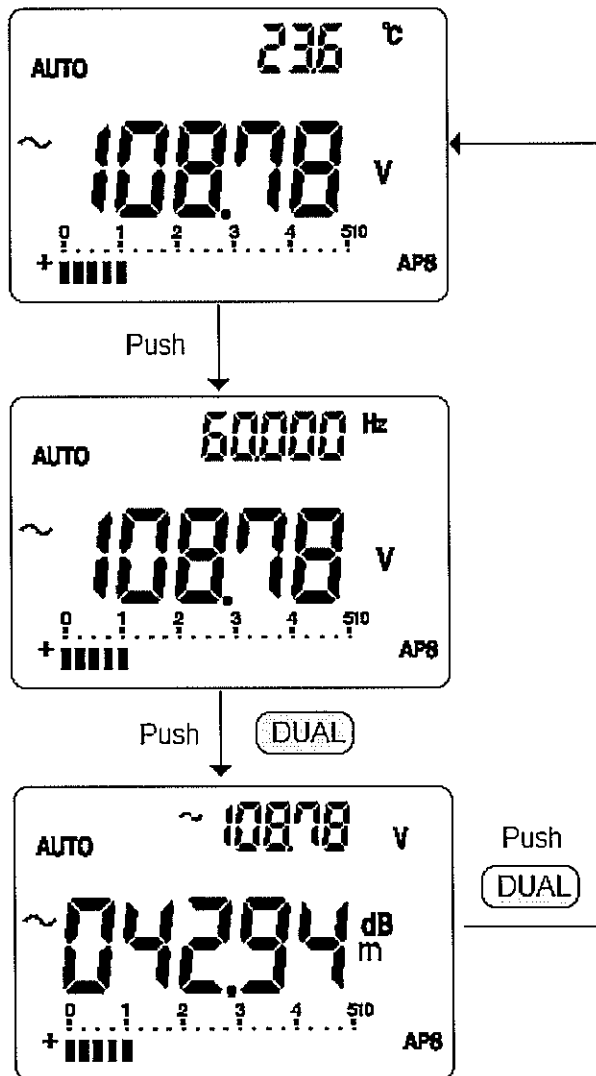











Figure- 40 Selecting by Dual button

■ **SHIFT Function by Blue Button (For model 2890A)**

Function	Primary display
 V	ACV
	dBm or dBV
 V	DCV
	ACV
	DC+AC
 mV	DCmV
	ACmV
	DC+ACmV
$\Omega$	$\Omega$
	Continuity $\Omega$
	nS
	
	Hz (Frequency Counter)
CX/ Temperature	CX
	Environment Temperature Compensation
	0°C (No ETC)
 µA	DCµA
	ACµA
	DC+ACµA
 mA	DCmA
	ACmA
	DC+ACmA
	%(0-20 or 4-20)
 A	DCA
	ACA
	DC+ACA
 OUT	Hz with Duty cycle (%)
	Hz with Pulse width (ms)



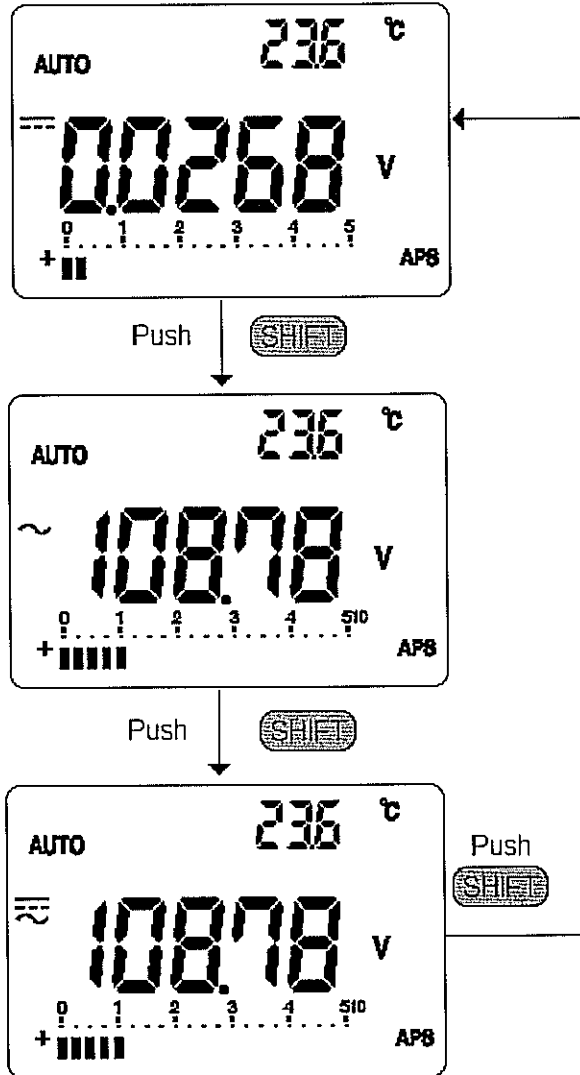

Figure-41 Shift V function by Blue button

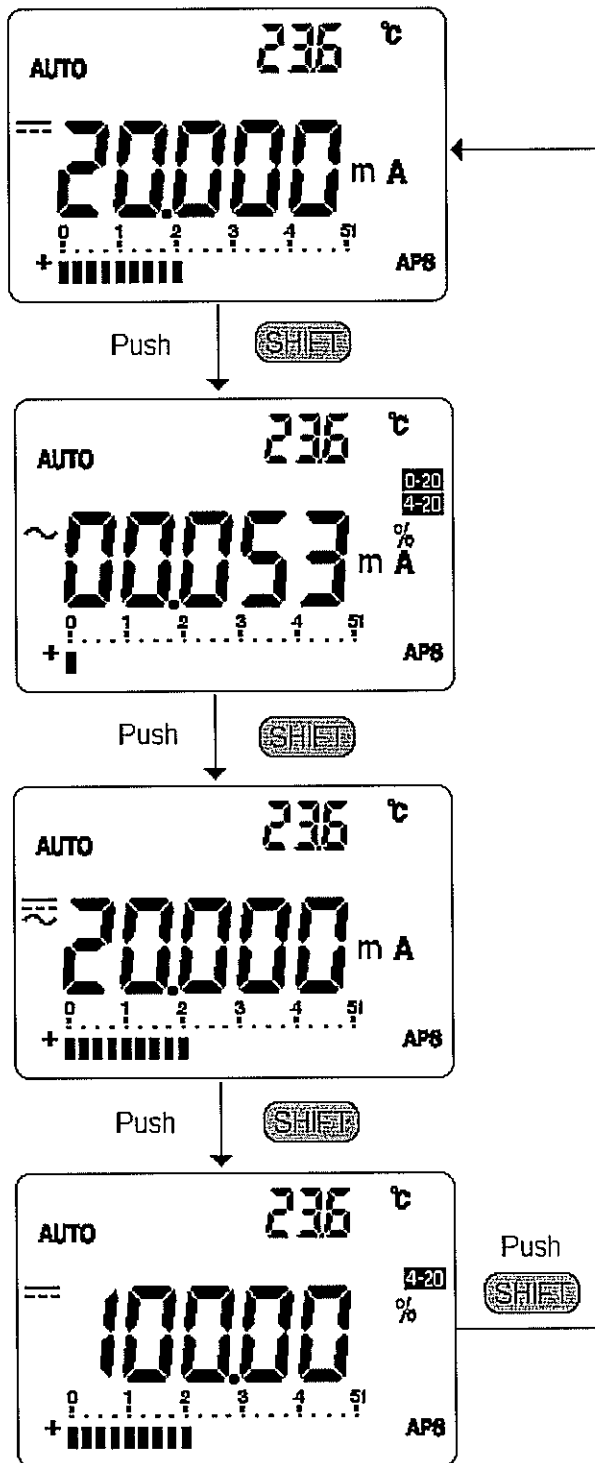

Figure- 42 Shift mA function by Blue button

■ **SHIFT Function by Blue Button (For model 2880B)**

Function	Primary display
~ V	ACV
	dBm or dBV
≡ V	DCV
~ mV	DCmV
	ACmV
Ω	Ω
	Continuity Ω
	nS
→	→
CX/ Temperature	CX
	Environment Temperature Compensation
	0°C (No ETC)
~ μA	DCμA
	ACμA
~ mA	DCmA
	ACmA
	%(0-20 or 4-20)
~ A	DCA
	ACA

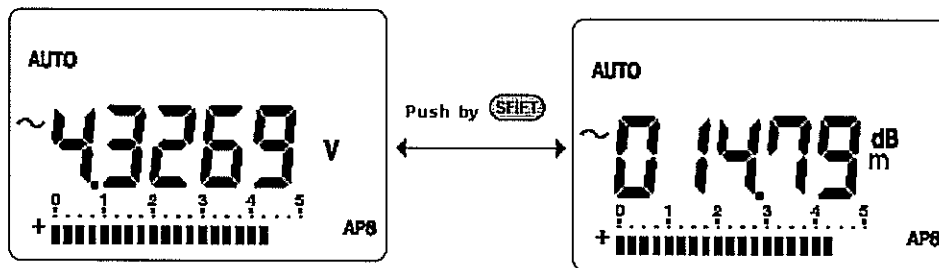

Figure- 43 Shift V function by Blue button

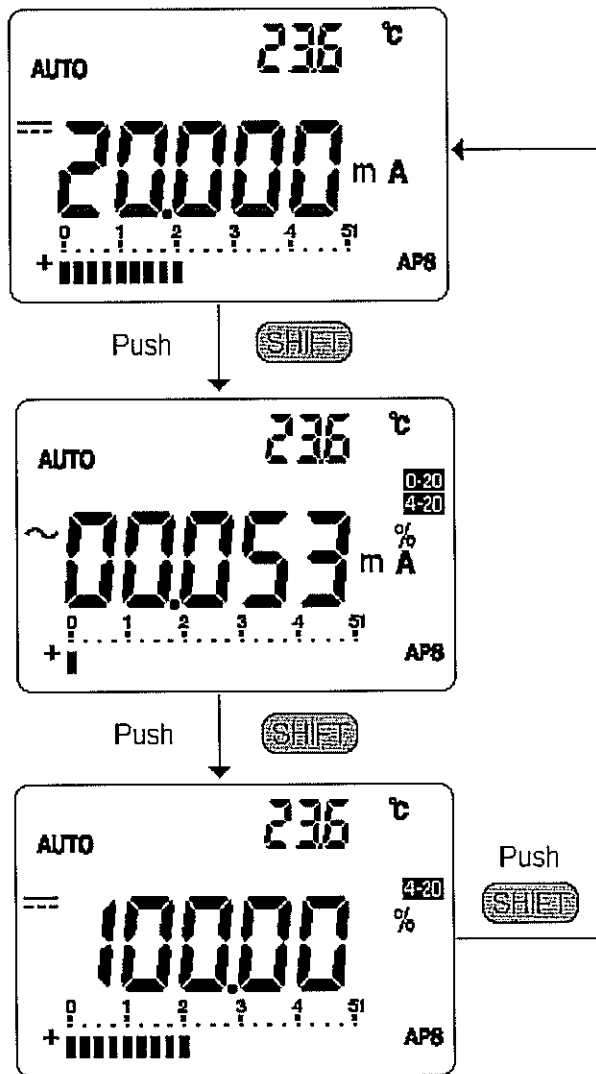

Figure- 44 Shift mA function by Blue button

## How to Operate

### ■ AC VOLTAGE MEASUREMENT

The meter presents AC voltage values as R.M.S. (Root Mean Square) readings. The RMS value is the equivalent dc voltage that would produce the same amount of heat in a resistance as the measured voltage. This meter features TRUE-RMS readings, which are accurate for sine-waves and other waveforms (with no dc offset) such as square waves, triangle waves, and staircase waves.

1. Set the rotary switch to " $\sim$ V".
2. Connect the Red and black test leads to "V" and "COM" input terminals.
3. Push "DUAL" to display frequency on secondary display.
4. Touch the probes to the test points and read the display.

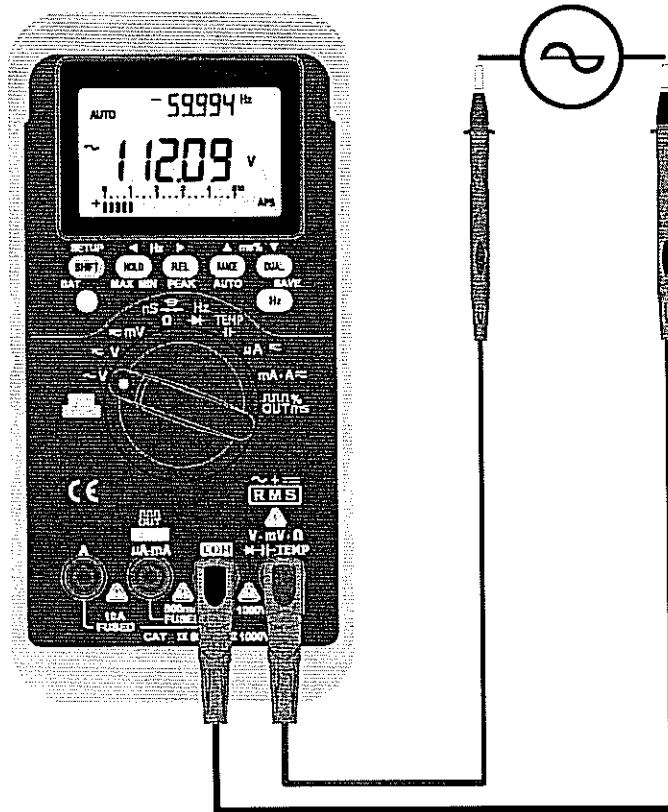

Figure- 45 Line power Voltage measurement

## ■ DC VOLTAGE MEASUREMENT

1. Set the rotary switch to "**V**".
2. Connect the Red and black test leads to "**V**" and "**COM**" input terminals.
3. Touch the probes to the test points and read the display.

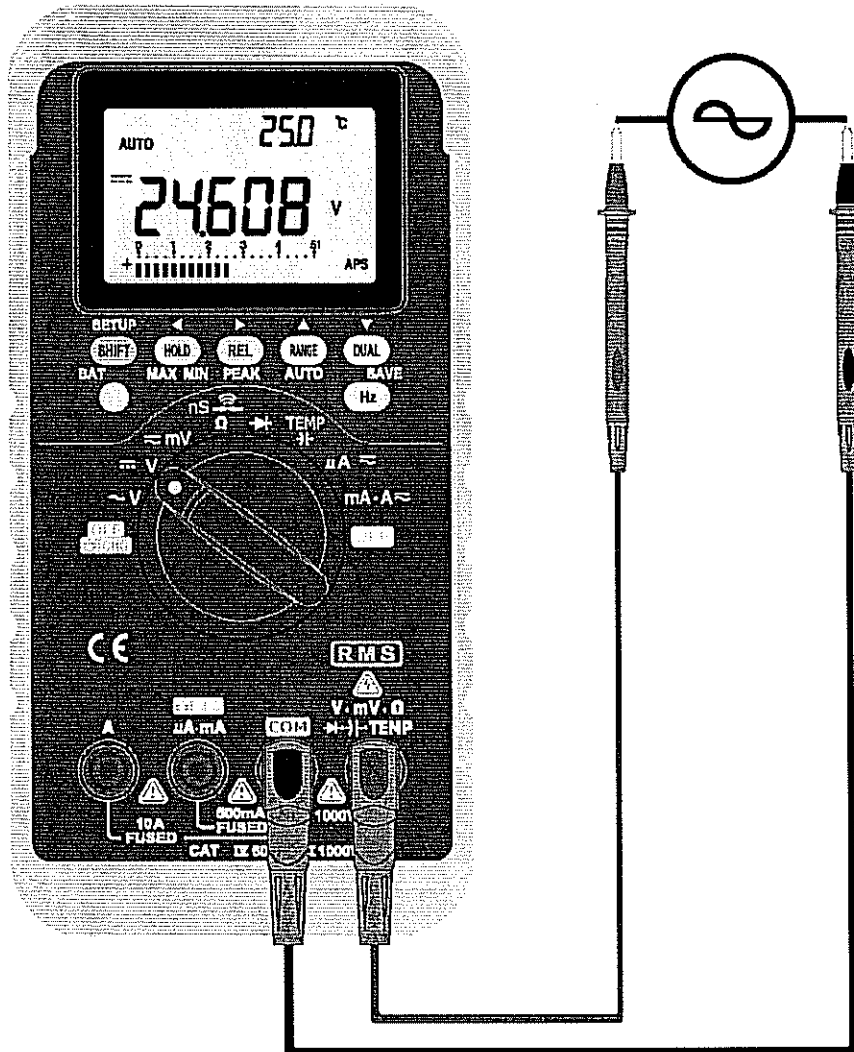

Figure- 46 Check the power source of transmitter

## ■ $\mu\text{A}$ Measurement

1. Set the rotary switch to " $\mu\text{A}$   $\sim$ ".
2. Connect the Red and black test leads to " $\mu\text{A}$ " and " $\text{COM}$ " input terminals.
3. Touch the probes to series connect to the test points and read the display.

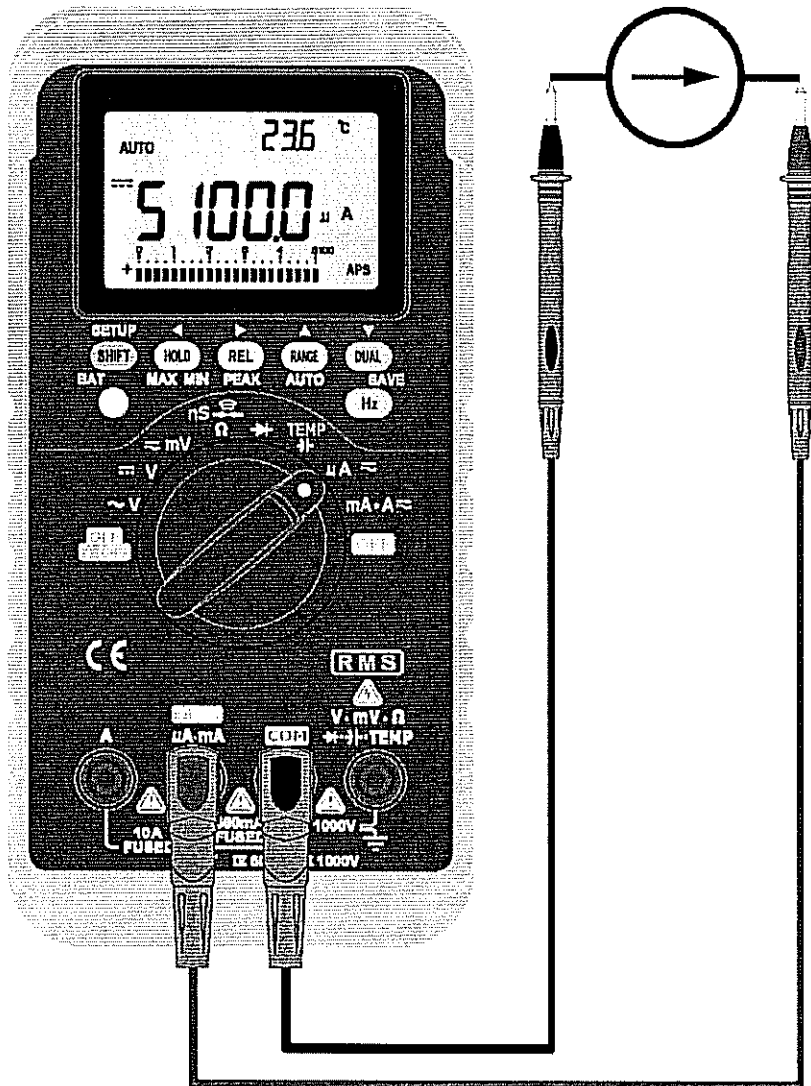

Figure- 47  $\mu\text{A}$  Measurement

## ■ mA Measurement

1. Set the rotary switch to "mA·A $\sim$ ".
2. Connect the Red and black test leads to "mA" and "COM" input terminals.
3. Touch the probes to series connect to the test points and read the display.

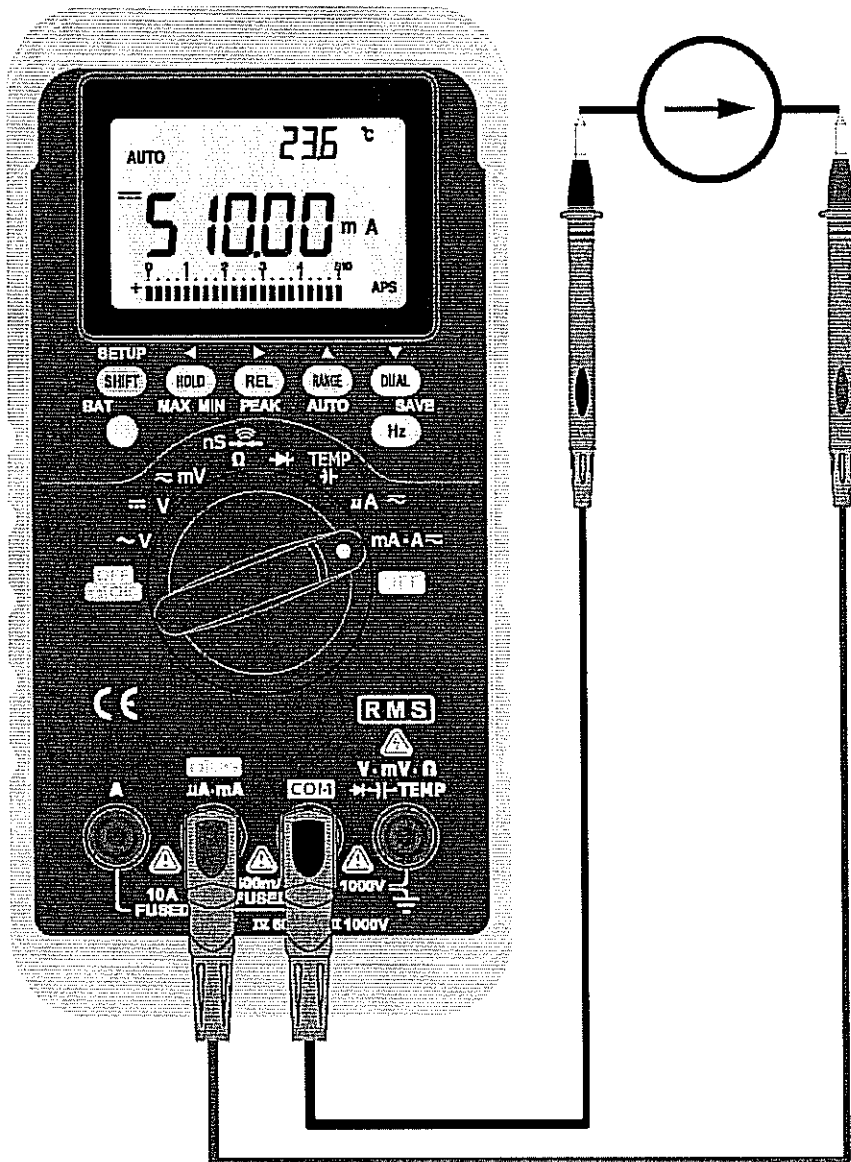

Figure- 48 mA Measurement



■ **% scale of 4-20mA**

The % scale for 4-20mA or 0-20mA is calculated by DCmA measurement. It will optimize the best resolution automatically as below table. The RANGE button and bar-graph is used for ranging 50mA and 500mA. The % scale for 4-20mA or 0-20mA is set two ranges as follows:

%(0-20 or 4-20mA)	DCmA
Always auto range	Auto or Manual range
999.99%	50mA
9999.9%	500mA

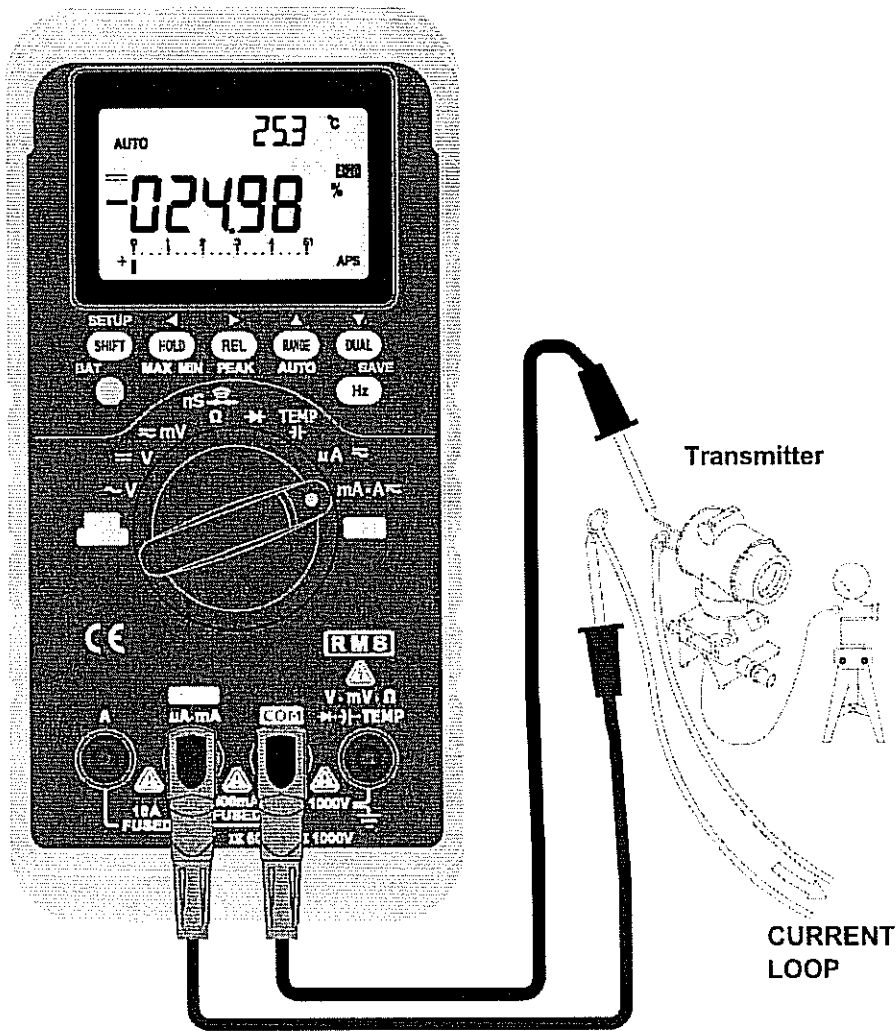

Figure- 49 % Scale of 4-20mA

## ■ A Measurement

1. Set the rotary switch to "**mA**·**A**".
2. Connect the Red and black test leads to "**A**" and "**COM**" input terminals. The meter set to the A measurement automatically when plugged test lead to "A" terminals.
3. Touch the probes to series connect to the test points and read the display

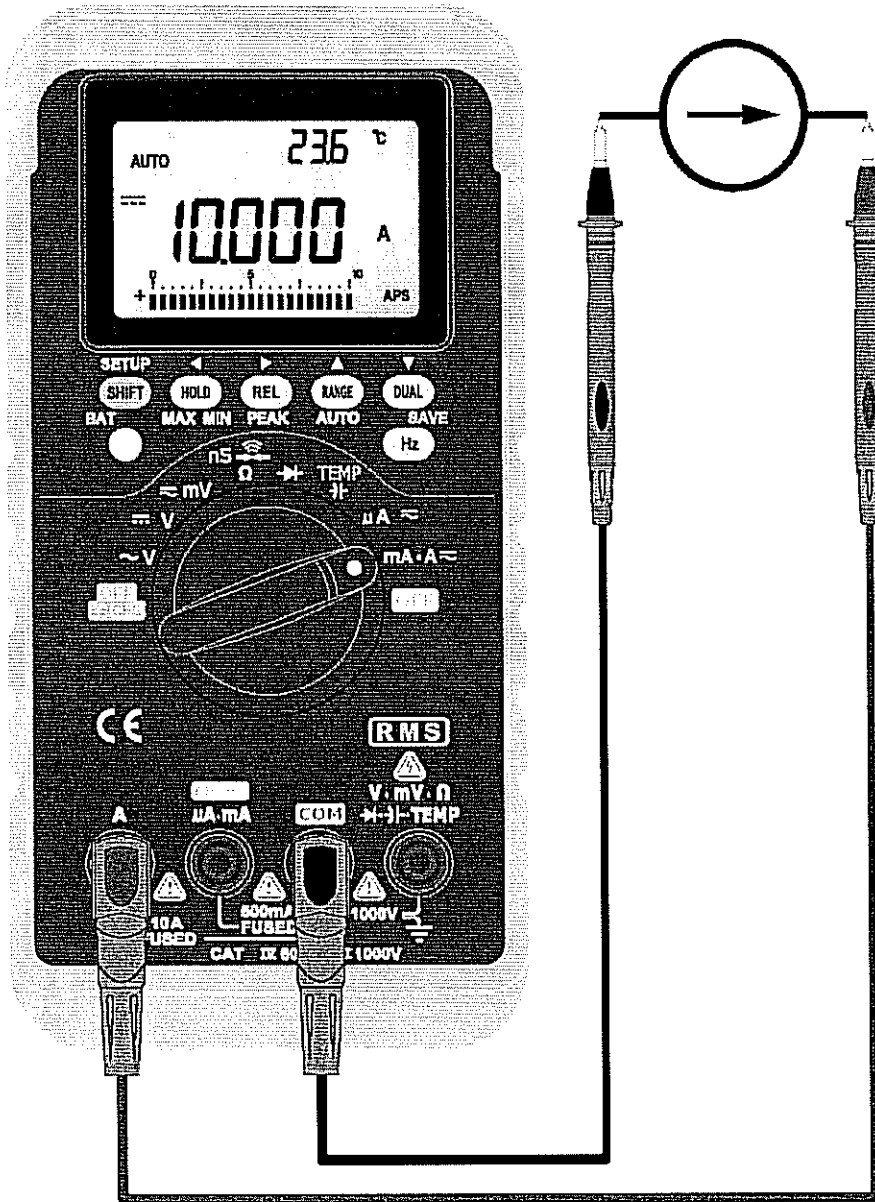

Figure- 50 A measurements

## ■ **Frequency counter**

The frequency count may use for low voltage application. Never measure the frequency to line power system.

1. Set the rotary switch to "**Hz**" position.
2. Press BLUE button to select frequency counter.
3. The secondary display shows the input signal will be divided prior. The "-1-" and "-100-" are divided signal to 1 and 100 respectively.
4. Connect the Red and black test leads to "**V**" and "**COM**" input terminals.
5. Touch the probes to the test points and read the display.
6. If the reading is unstable or zero, push DUAL button momentarily to select signal divide 100.
7. If the reading is unstable, that means the signal is out of the specification.
8. Push Hz button momentarily to step through duty cycle, pulse width and frequency measurement as the secondary display indicated "-1-".

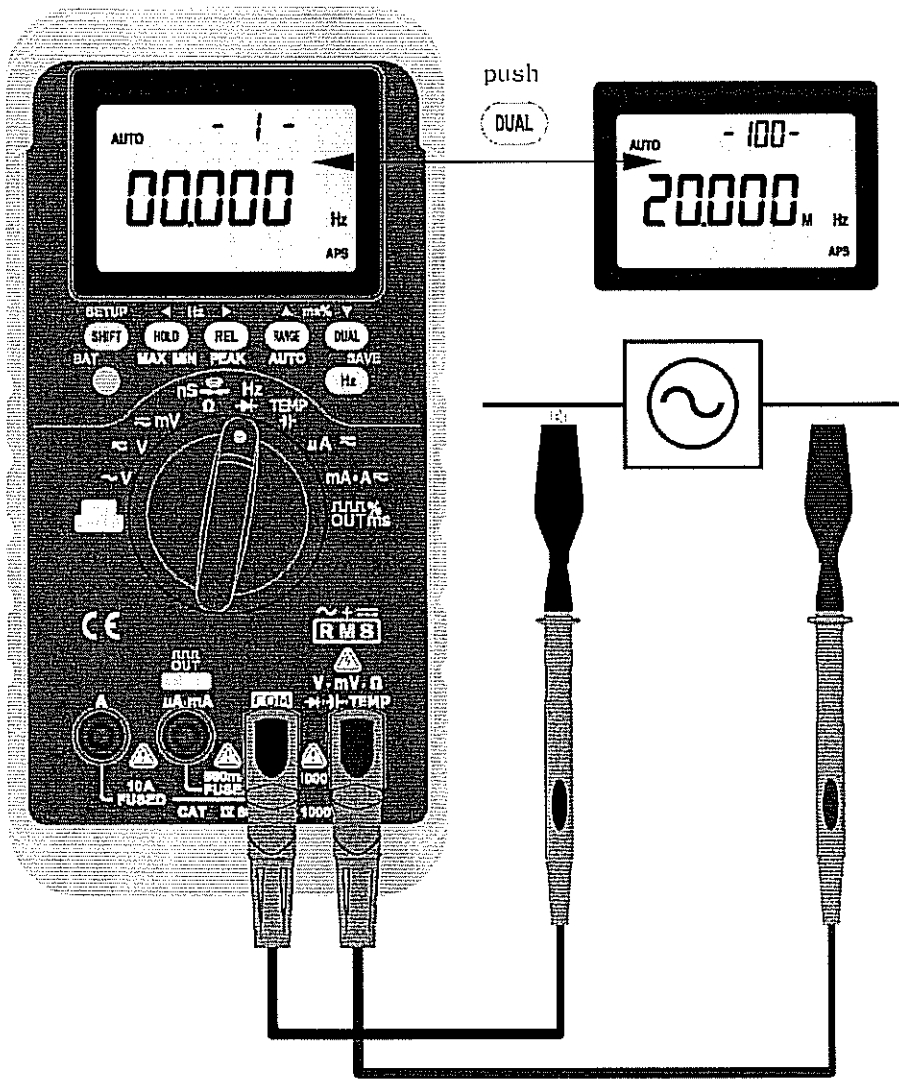

Figure- 51 Frequency Counter

## ■ RESISTANCE/ CONTINUITY MEASUREMENT

### ⚠ Caution

To avoid possible damage to the meter or the equipment under test, disconnect circuit power and discharge the capacitor before measuring capacitance.

The meter measures resistance by sending a small current through the circuit. The unit is the ohm ( $\Omega$ ).

For Ohm test, press "SHIFT" button momentarily to select Audible continuity, Conductance and Resistance measurements. The continuity range is set to 0-500.00 $\Omega$ . While testing continuity, the beeper will sound if the resistance falls below 10 $\Omega$ .

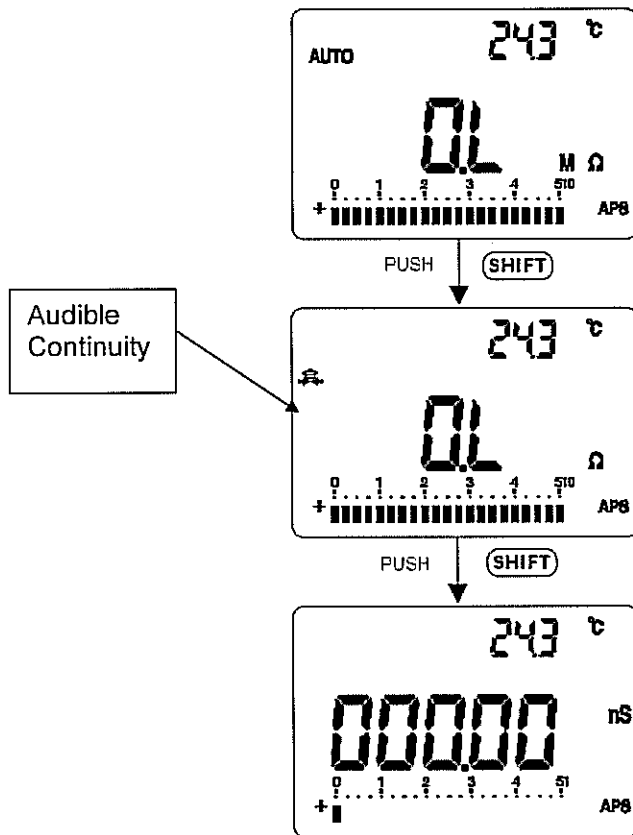

Figure- 52 Select Continuity

For other ranges, the beeper will sound if the resistance falls below the typical values indicated in below table.

**Table- 6 Beeper Responses in Continuity Test**

<b>Measuring range</b>	<b>Beeper On if</b>
<b>500.00 <math>\Omega</math></b>	<b>&lt;10 <math>\Omega</math></b>
<b>5.0000 k<math>\Omega</math></b>	<b>&lt;100 <math>\Omega</math></b>
<b>50.000 k<math>\Omega</math></b>	<b>&lt;1 k<math>\Omega</math></b>
<b>500.00 k<math>\Omega</math></b>	<b>&lt;10 k<math>\Omega</math></b>
<b>5.0000 M<math>\Omega</math></b>	<b>&lt;100 k<math>\Omega</math></b>
<b>50.000 M<math>\Omega</math></b>	<b>&lt;1 M<math>\Omega</math></b>

1. Set the rotary switch to " $\Omega$ ".
2. Connect the red/ black test leads to " $\Omega$ " and "**COM**" input terminals, respectively.
3. Touch the probes to resistor (or shunt) and read the display.
4. Press "**BLUE**" button momentarily to select Audible continuity function. The continuity range is 0-500.00 $\Omega$ . While testing continuity, the beeper will sound if the resistance falls below 10 $\Omega$  in the range of 500.00 $\Omega$ .

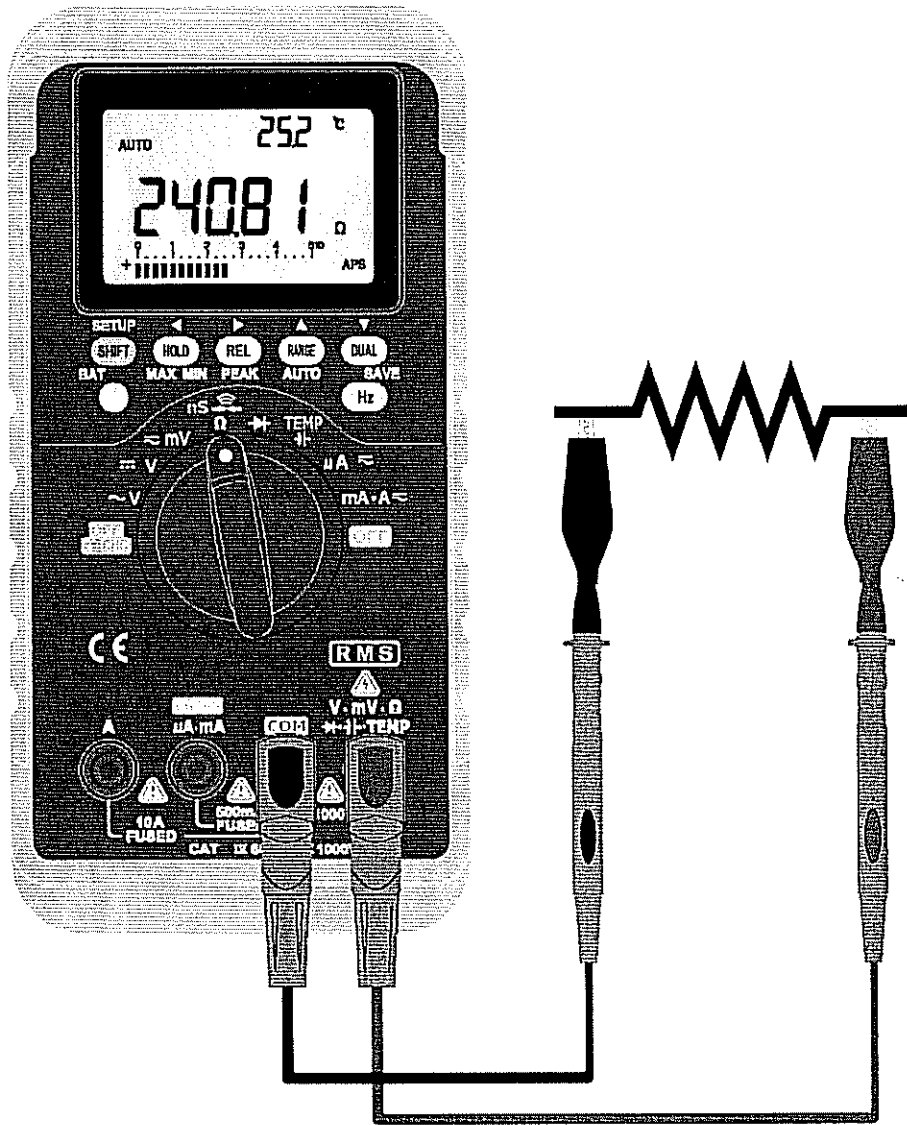

Figure- 53 Resistance measurement

## ■ CONDUCTANCE MEASUREMENT

Conductance is the reciprocal of resistance. High values of conductance correspond to low values of resistance. The unit of conductance is the Siemens (S). The 50 nS range measures conductance in nano-siemens (1 nS = 0.000000001 Siemens). Because small conductance correspond to extremely high resistance, the nS range lets you easy calculate and determine the resistance of components up to 100 G $\Omega$  (1 nS = 1,000 M $\Omega$ = 1G $\Omega$ )

1. Set the rotary switch to " $\Omega$ ".
2. Connect the red/ black test leads to " $\Omega$ " and "**COM**" input terminals, respectively.
3. Press "**SHIFT**" button momentarily to select conductance measurement.
4. Touch the probes to resistor and read the display.
5. High-resistance readings are susceptible to electrical noise. Use averaging to smooth out most noisy readings. Refer to Dynamic recording mode.



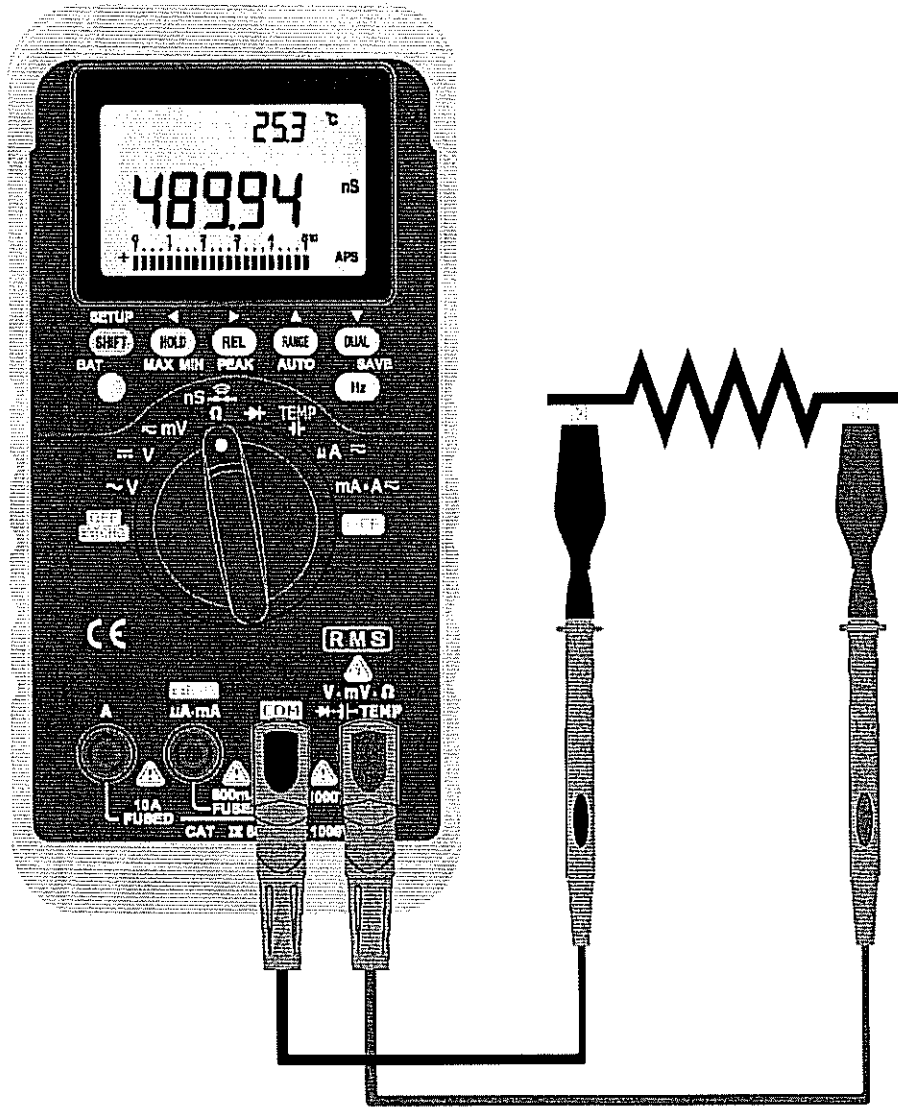

Figure- 54 Conductance measurement

## ■ **DIODE CHECK**

A good diode allows current to flow in one direction only. To test a diode, turn the power off, remove the diode from the circuit, and proceed as follows:

1. Set the rotary switch to "**→|**" position.
2. Connect the red/ black test leads to "**→|**" and "**COM**" input terminals, respectively.
3. Touch the red lead to the positive (anode) side of the diode and the black lead to the negative side (cathode, side with band or bands). The meter can display diode voltage drops to approximately 2.1 V. A typical voltage drop is 0.3V~ 0.8V and the meter will sound a beep to remind user.
4. Reverse the probes and measure the voltage across the diode again. If the diode is:
  - **Good:** "**OL**" is displayed.
  - **Short:** Near 0 V drop is displayed in both directions, and the beeper sounds continuously.
  - **Open:** "**OL**" is displayed in both directions.
5. Repeat step 3 and 4 for other diodes.

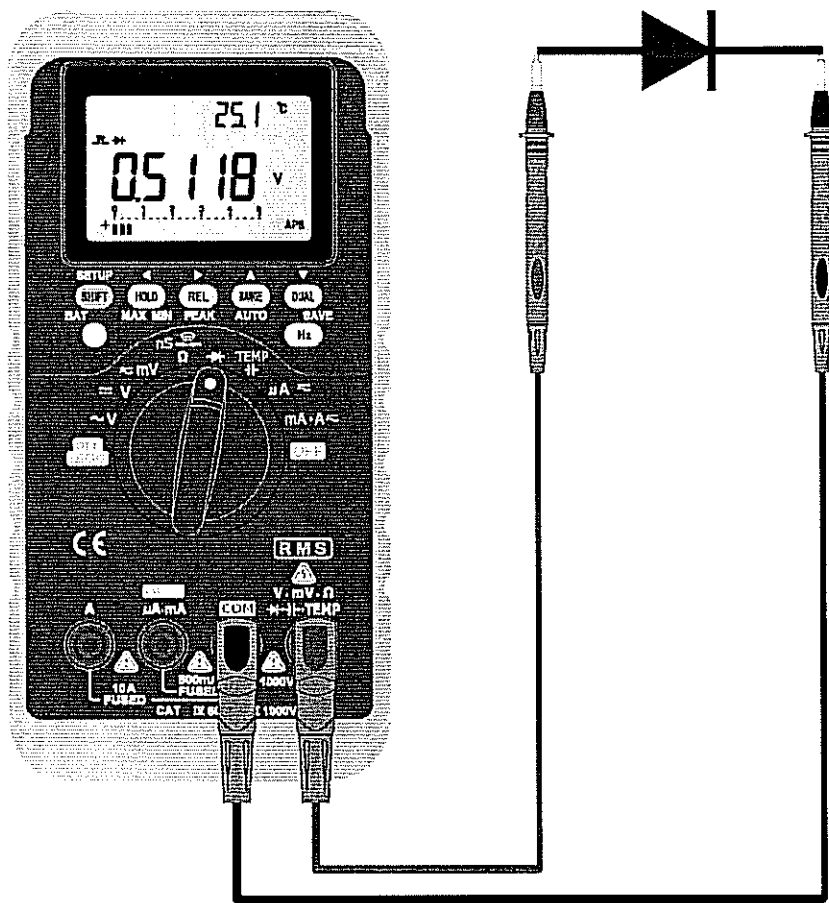

Figure- 55 Forward Bias of Diode Measurement

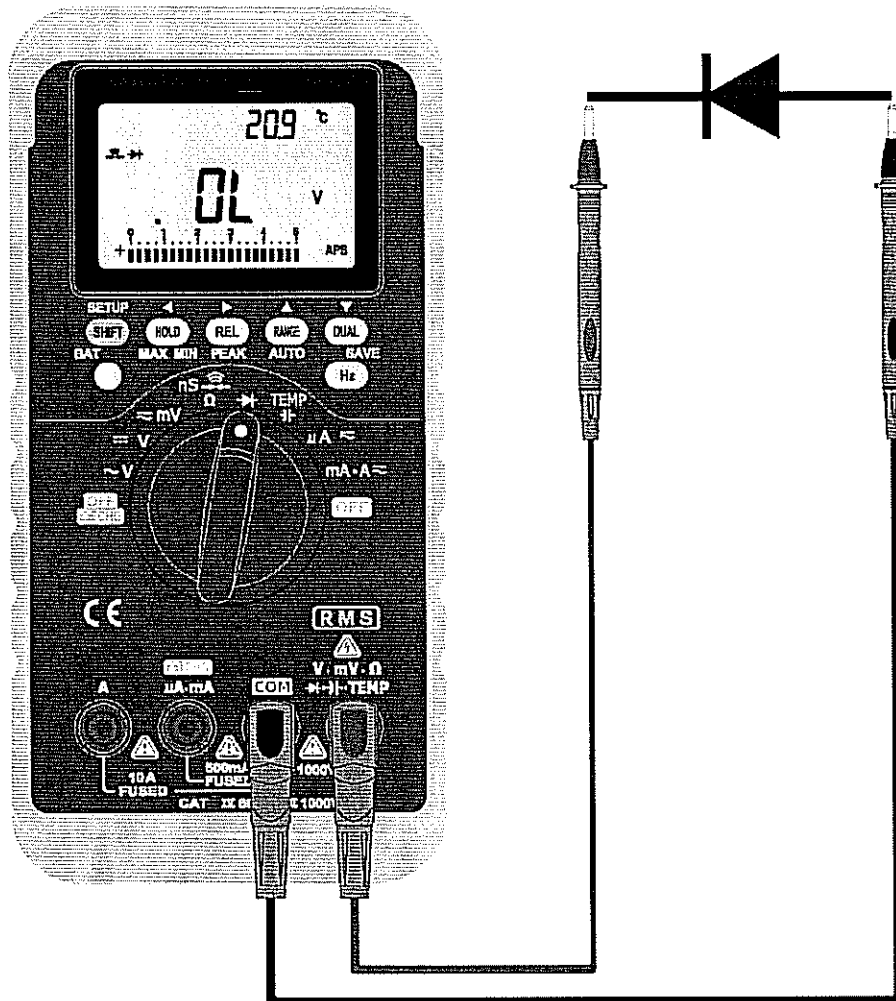

Figure- 56 Reverse Bias of Diode Measurement

## ■ CAPACITANCE

### △ Caution

To avoid possible damage to the meter or the equipment under test, disconnect circuit power and discharge the capacitor before measuring capacitance. Use the DC voltage function to confirm that the capacitor has been discharged.

Capacitance is the ability of a component to store an electrical charge. The unit of capacitance is the farad (F). Most capacitors are within the range for nanofarad (nF) to microfarad ( $\mu$ F). The meter measures capacitance by charging the capacitor with a known current for a known period of time, measuring the resulting voltage, and then calculating the capacitance. The larger capacitors will take longer time to charge. The sign of "⏏" means charging capacitor, and the sign of "⏏" means discharging capacitor. To improve the measurement accuracy of small value capacitors, press REL with the test leads open to subtract the residual capacitance of the meter and leads.

**Measuring tip:** For measuring the capacitor more than 10000 $\mu$ F, it suggested to discharge capacitor first and selected suitable range to measure it. That will speed up measuring time for get the correct value.

1. Set the rotary switch to "⏏" position.
2. Connect the red/ black test leads to "⏏" and "COM" input terminals, respectively.
3. Be sure the polarity for capacitor, red probe shall be touched "+" end of capacitor.
4. Read the display.

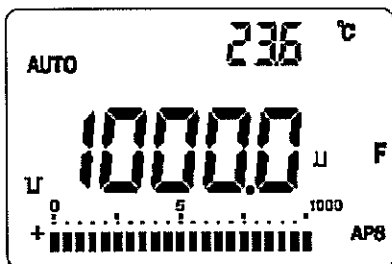

Disaharging

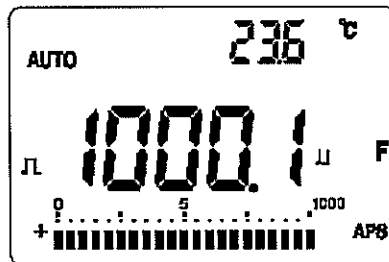

Charging

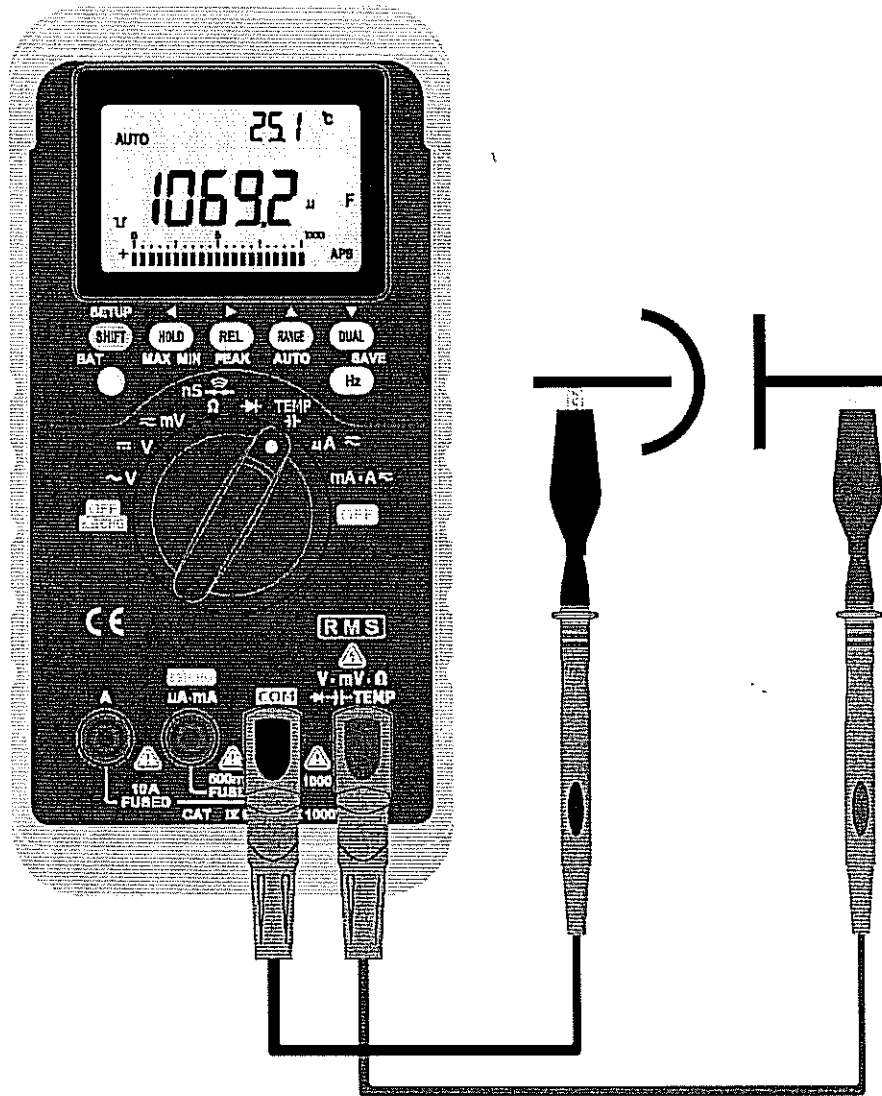

Figure- 57 Capacitance measurement

## ■ BIPOLAR JUNCTION TRANSISTOR

The BJT (bipolar junction transistor) is composed of input and output circuits by using one of electrodes namely, emitter, base, or collector as the common terminal. The transistor has polarities for PNP or NPN type. To get the related data sheet from manufacturers will be highly recommended. Sometime it will waste time. You can recognize the transistor by this meter. Following procedure may guide you how to recognize the polarities and poles of a transistor:

### How to recognize NPN/PNP

1. Set the rotary switch to "→H" position.
2. Connect the red/ black test leads to "→H" and "COM" input terminals, respectively. The "→H" end of input provides positive test voltage.
3. Assume number 1, 2, and 3 for a TO-92 transistor as following Figure.

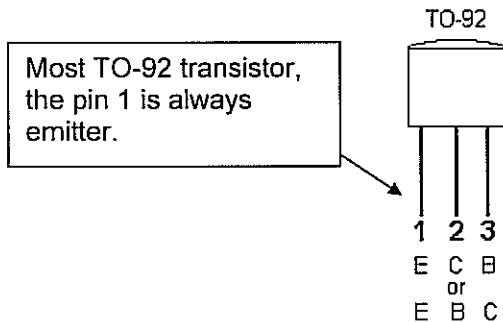

**Figure- 58 TO-92 Transistor**

4. Touch pin 1 by red probe, and pin 2 by Black probe. If the measuring is OL, reverse the probes. If the measuring value is still OL. You can assume both pins would be Emitter and Collect poles. The residual pin 3 is Base pole. Always to find out which pin is Base pole first. Refer to following Table:

PIN	Probe Red/Black	Probe Black/Red	Base
<b>1-2</b>	OL	OL	<b>3</b>
<b>1-3</b>	OL	OL	<b>2</b>
<b>2-3</b>	OL	OL	<b>1</b>

5. Touch Base pole by RED probe, and connect black probe to other pins. Record the reading. Reverse the Red/ black probes. Record the reading. Then recognize the polarities (NPN or PNP) and Poles according to following table. The  $V_{be}$  is always greater than  $V_{bc}$ . Most TO-92 transistor, the pin 1 is always emitter. Anyway, please check related data sheet from Manufacturers according. See following Table

Base =Pin 3

PIN	3-1	3-2	Pole (123) (Vbe>Vbc)	NPN/PNP
Probe Red/Black	0.6749V	0.6723V	ECB	NPN
	0.6723V	0.6749V	CEB	NPN
Black/Red	0.6749V	0.6723V	ECB	PNP
	0.6723V	0.6749V	CEB	PNP

Base= Pin2

PIN	2-1	2-3	Pole (123) (Vbe>Vbc)	NPN/PNP
Probe Red/Black	0.6749V	0.6723V	EBC	NPN
	0.6723V	0.6749V	CBE	NPN
Black/Red	0.6749V	0.6723V	EBC	PNP
	0.6723V	0.6749V	CEB	PNP

Base=Pin 1

PIN	1-2	1-3	Pole (123) (Vbe>Vbc)	NPN/PNP
Probe Red/Black	0.6749V	0.6723V	BEC	NPN
	0.6723V	0.6749V	BCE	NPN
Black/Red	0.6749V	0.6723V	BEC	PNP
	0.6723V	0.6749V	BCE	PNP

6. The other type TO3 package as following drawing

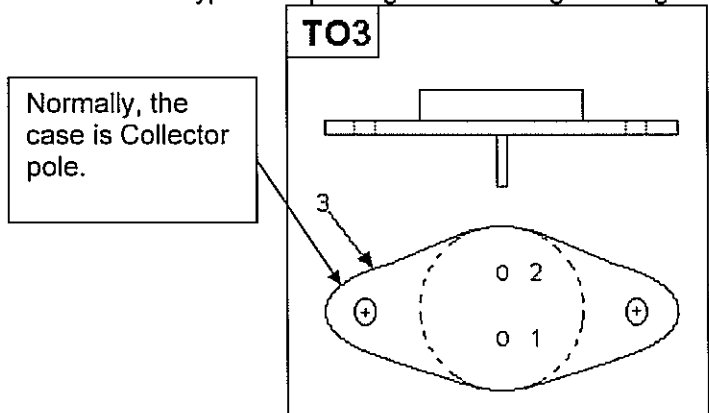

**Figure- 59 TO-3 Transistor**

For example of 2N3055, a silicon NPN high power transistor, According to previous procedures, the base pole will be pin 2.

Base= Pin2

PIN	2-1	2-3	Pole (123) (Vbe>Vbc)	NPN/PNP
Probe Red/Black	<b>0.5702V</b>	<b>0.5663V</b>	<b>EBC</b>	<b>NPN</b>



## ■ JFET SWITCH TEST

The JFET (Junction Field-Effect Transistor) is composed of input and output circuits by using one of electrodes namely, Drain, Gate, or Source as the common terminal. The JFET has different type for P or N channel switch. To get the related data sheet from manufacturers will be highly recommended. You can recognize the JFET by this meter. Following procedure may guide you how to recognize JFET.

1. Set the rotary switch to " $\Omega$ " position.
2. Connect the red/ black test leads to " $\Omega$ " and "COM" input terminals, respectively. The " $\Omega$ " end of input provides positive test voltage.
3. Assume number 1, 2, and 3 for a TO-92 JFET as following Figure.

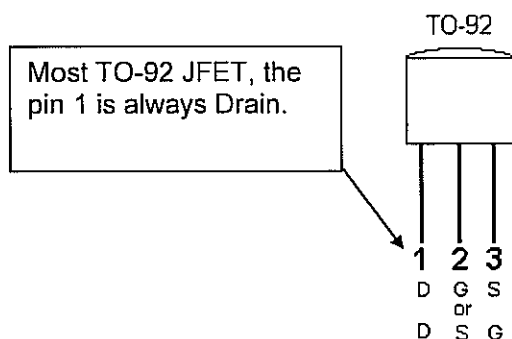

**Figure- 60 TO-92 JFET**

4. Touch pin 1 and pin 2 by red and black probes, to get the value. Then reverse the probes. If the two measuring value is  $< 1k\Omega$ . You can assume both pins would be Drain and Source poles. The residual pin 3 is Gate pole. Always to find out which pin is Gate pole first. Refer to following Table:

PIN	Probe Red/Black	Probe Black/Red	Gate
<b>1-2</b>	$< 1k\Omega$	$< 1k\Omega$	3
<b>1-3</b>	$< 1k\Omega$	$< 1k\Omega$	2
2-3	$< 1k\Omega$	$< 1k\Omega$	1

5. To judge P-channel switch or N-channel, by constant voltage source and verify the RDS (Drain-Source on Resistance). Normal, both channel types will be switched when VGS) is equal to 0 V.
6. Connect the input probes to Drain and Source poles.
7. Then connect the red output alligator through a resistor of  $100K\Omega$  to Gate pole, the black output alligator to black input probe.
8. If the  $R_{DS}$  increased as the V (GS) is negative voltage, this JFET will be N-channel. You can set DC power supply voltage output from **+00.000V** to

-15.000V, and the  $R_{DS}$  will be increased until "OL" of resistance measurement. You will know the cutoff voltage for this N-channel switch.

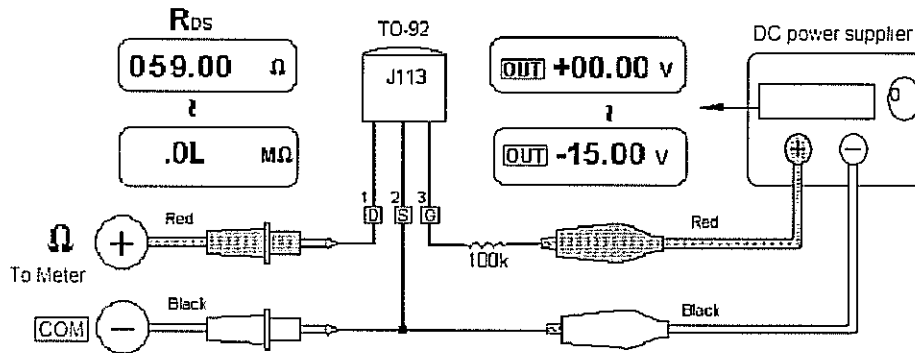

Figure- 61 N- Channel JFET

9. If the  $R_{DS}$  increased as the V (GS) is positive voltage, this JFET will be P-channel. You can set DC power supply voltage output from 0.000V to +15.000V, and the  $R_{DS}$  will be increased until "OL" of resistance measurement. You will know the cutoff voltage for this P-channel switch.

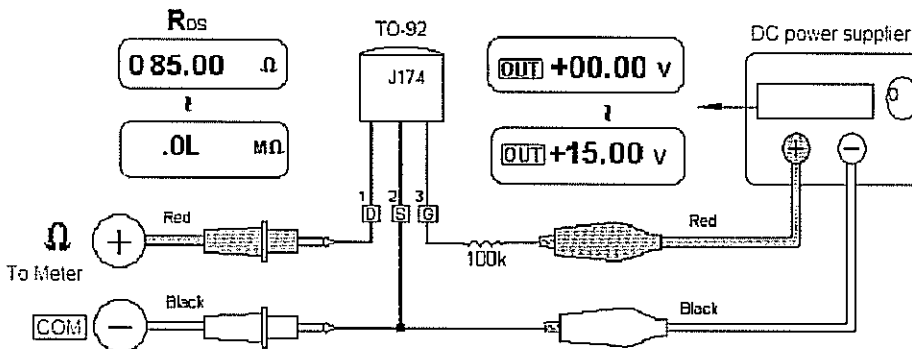

Figure- 62 P- Channel JFET

## ■ **Temperature Measurement (optional adapter required)**

### **CAUTION**

**Do not bend the thermocouple leads, sharply.  
Repeatedly bending the leads can break them.**

The bead type thermocouple probe is suitable for making temperature measurements from  $-40^{\circ}\text{C}$  ( $^{\circ}\text{F}$ ) to  $204^{\circ}\text{C}$  ( $399^{\circ}\text{F}$ ) in Teflon compatible environments. Above this temperature, toxic gas might be emitted. Do not immerse this thermocouple in liquids. For best results, use a thermocouple probe designed for each application (i.e. an immersion probe for liquid or gel, an air probe for air measurements, etc.). Follow the measuring techniques as below:

- Clean the measurement surface and make sure the probe is attached securely to the surface.
  - When measuring above ambient temperatures, move the thermocouple on the surface until you get the highest temperature reading.
  - When measuring below ambient temperatures, move the thermocouple on the surface until you get the lowest temperature reading.
  - The sensor plugged into meter shall be putted on the operating environment for 1 hour at least.
  - If you want to have quick operation, please use the  $0^{\circ}\text{C}$  compensation to see the temperature variation of the thermocouple sensor. The  $0^{\circ}\text{C}$  compensation will assist you to measure relative temperature immediately.
1. Turn the rotary switch to CX/TEMP position.
  2. Press BLUE button select temperature measurement.
  3. Plug the adapter with thermocouple probe into the "TEMP" and "COM" input terminals.
  4. Attach the thermocouple to the surface being measured.
  5. Read the display.
  6. If you are working on a varied environment, which the ambient temperature is non-constant. It is another way to quickly measure the relative temperature by  $0^{\circ}\text{C}$  compensation. Press "SHIFT" button to select  $0^{\circ}\text{C}$  compensation.
  7. Don't touch the surface you want to measure by thermocouple probe. Wait for a constant reading, then press "REL" button to the reading to be relative reference temperature.
  8. Attach the thermocouple to the surface being measured
  9. Read display for the relative temperature.

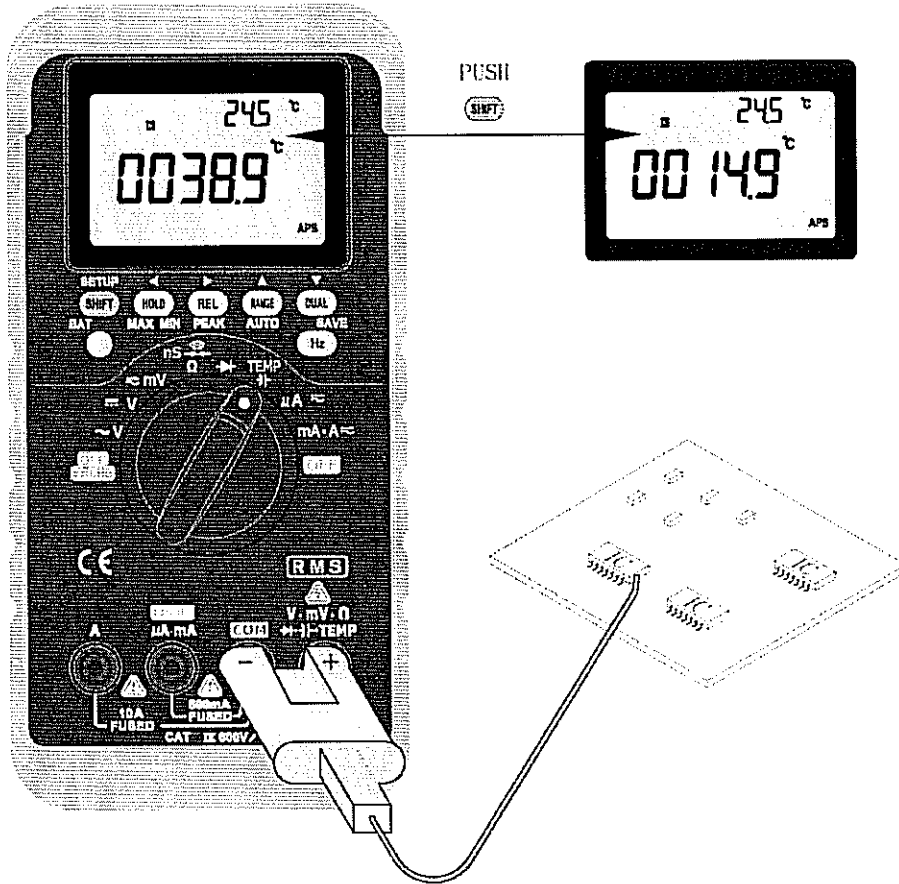

Figure- 63 Surface temperature measurement

### ■ Square Wave Output (Model 2890A only)

You can use square wave outputs as a source, for examples, Oscilloscope, Digital multi-meter, Buzzer etc.

1. Set the rotary switch to "OUT" position.
2. Connect the Red and black alligator clips to "OUT" and "COM" output terminals.
3. Connect the "OUT" end of meter to the probe of an oscilloscope
4. Connect the "COM" ends of meter to the ground of an oscilloscope.
5. Use an oscilloscope to monitor the wave change.
6. Set duty cycle to 50.00%.
7. Set square wave output value to 100Hz/ 50.00% for checking the Horizontal timing scale of an oscilloscope.
8. To select different frequency, and vary the duty cycle.

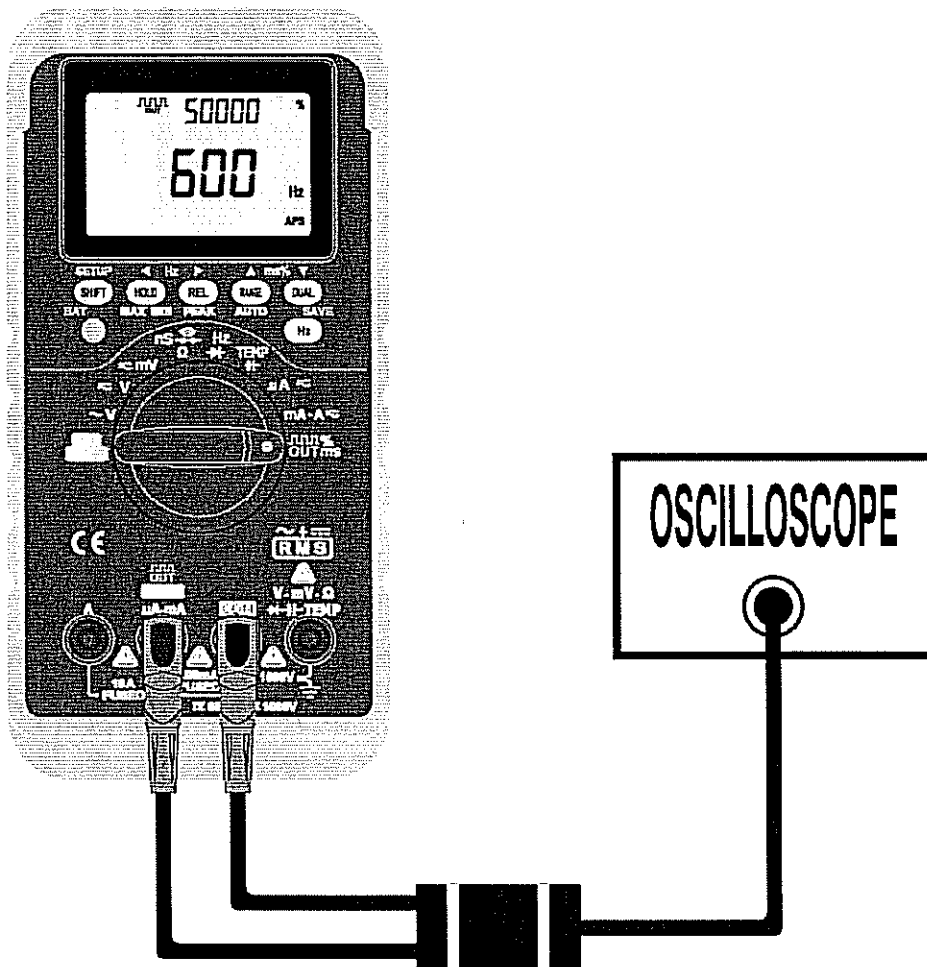

Figure- 64 Square Wave Output

# SPECIFICATIONS

## ■ GENERAL SPECIFICATION

### Display:

- Both primary and secondary displays are 5-digit liquid crystal display (LCD) with maximum reading of 51000 counts.
- Automatic polarity indication.

### Function:

- DCV, ACV, DCA, ACA, OHM, Diode check, Audible continuity, Temperature, Frequency, Duty cycle and Pulse Width tests.
- Including **AC+DC** true RMS measurement for both voltage and current.
- Environment temperature indication with each measurement.
- dBm with selectable reference impedance and dBV measurement
- Frequency-counter measurement up to 20MHz.
- 1-ms peak hold for capturing glitch easily.
- The % scale readout for 4-20mA and 0-20mA measurement
- A unique square wave output with 28 types of frequency and adjustable duty cycle.
- Battery capacity indication.
- EL Backlit display for easy reading in the dark.
- Min/Max/Average, Data Hold with Manual or Auto Trigger and Relative modes
- Bi-directional optic computer interface with SCPI commands
- One-year calibration cycle suggested.

### Measuring rate (Approx.):

Function	Measuring Rate (approx.)
ACV	3.75
ACV + dB	3.75
DCV (V or mV)	3.75
ACV (V or mV) <b>(2890A)</b>	3.75
AC+DC V (V or mV) <b>(2890A)</b>	1.65
$\Omega$ / nS	7.5
Diode	7.5
Capacitance	4 (< 100 $\mu$ F)
DCA ( $\mu$ A, mA or A)	3.75
ACA ( $\mu$ A, mA or A)	3.75
AC +DC A ( $\mu$ A, mA or A) <b>(2890A)</b>	1.65
Temperature	3
Frequency	1.12 (>1Hz)
Duty cycle	1.12 (>1Hz)
Pulse width	0.56 (>1Hz)

**Low battery indicator:**

The "🔋" appears when the battery voltage drops below 6.0V (approx.).

**Operating temperature:** from 0 °C to 50 °C.

**Storage temperature:** -20 °C to 60 °C with battery removed.

**Relative Humidity (R.H.):** maximum 80% R.H. for temperature up to 31 °C decreasing linearly to 50% R.H. at 50 °C

**Temperature coefficient**

0.15x (specified accuracy) / °C (from 0 °C to 18 °C or 28 °C to 50 °C)

**Common Mode Rejection Ratio (CMRR):**

>90 dB at DC, 50/60 Hz±0.1% (1kΩ unbalanced)

**Normal Mode Rejection Ratio (NMRR):** > 60 dB at 50/60 Hz±0.1%

**Power supply:**

Single standard 9V Battery can use Alkaline or Carbon-zinc.

Battery types	ANSI/ NEDA	IEC
Alkaline	1604A	6LR61
Carbon-zinc	1604D	6F22

The rechargeable battery should be 9V Ni-MH (Nickel-Metal Hydride battery)

Power Consumption: 480mVA maximum with backlit

**Battery life:**

- 24 hours for DC voltage measurement (approx.) (The new Ni-MH 170mA batteries have been fully charged.)
- 80 hours for DC voltage measurement (approx.) (Based on new alkaline 9V/545mAH Battery)

**Charging time:** <135 minutes approx. at the environment of 10 °C to 30 °C. (If the battery has been deep-discharged, a prolonged charging time is required to bring the battery back to full capacity.)

**Dimension:** 41 (H) \* 90 (W) \* 192 (L) mm without holster.

**Weight:** 675 grams with holster and battery/ 936 grams with full package

**Standard Accessories:**

Test leads (a pair), Starting Guide, Instruction manual and 9V battery.

**Optional Accessories:**

Communication package, 9V NiMH battery, external adaptor, power cord, Thermal input adapter and Thermocouple probe.

**Safety:** Designed in compliance with EN61010-1 (IEC1010-1) for CAT-III 1000V and CAT-IV 600V, Pollution Degree II Environment. EMC designed in compliance with EN61326.



## ■ ELECTRICAL SPECIFICATIONS FOR MODEL 2890A

Accuracy is given as  $\pm$ (% of reading + counts of least significant digit) at 23°C  $\pm$  5°C, with relative humidity Less than 80% R.H.

### □ DC mV/ Voltage

Range	Resolution	Accuracy	Overload Protection
50mV	0.001mV	0.05% +50 *N2	1000V for the circuits <0.3A short circuit.
500mV	0.01mV	0.025% +5	
1000mV	0.1mV		
5V	0.0001V		1000V
50V	0.001V		
500V	0.01V		
1000V	0.1V	0.03%+5	

Notes:

1. Input impedance: >1G $\Omega$  for 50mV~1000mV ranges. For 5V~1000V ranges, 10M $\Omega$  (nominal) for single display and parallel connected with 1.1M $\Omega$  as dual display.
2. The accuracy could be 0.05%+5, always use relative function to zero thermal effect (short test leads) before measuring the signal.

### □ AC mV/ V (TRUE RMS: From 5% to 100% of range)

Range	Resolution	Accuracy				
		20~45Hz	45~1k Hz	1k~10k Hz	10k~20k Hz	20k~100k Hz
50mV	0.001mV	1%+60	0.4%+40	0.7%+40	1.5%+40	3.5%+120
500mV	0.01mV	1%+60	0.4%+25	0.4%+25	1.5%+40	3.5%+120
1000mV	0.1mV	1%+60	0.4%+25	0.4%+25	1.5%+40	3.5%+120
5V	0.0001V	1%+60	0.4%+25	0.4%+25	1.5%+40	3.5%+120
50V	0.001V	1%+60	0.4%+25	0.4%+25	1.5%+40	3.5%+120
500V	0.01V	1%+60	0.4%+25	0.4%+25	1.5%+40	3.5%+120*3
1000V	0.1V	1%+60	0.4%+40	0.4%+40	1.5%+40*3	No spec.

Notes:

1. Overload Protection: 1000V R.M.S.; 1000V R.M.S. for the circuits <0.3A short circuit for mV ranges.
2. Input impedance: >1G $\Omega$  for 50mV~1000mV. 1.1M $\Omega$  (nominal) in parallel with <100pF for 5V~1000V ranges
3. Input voltage is lower than 200Vrms.
4. Crest factor  $\leq$  3

**□ AC+DC mV/ VOLTAGE (TRUE RMS: From 5% to 100% of range)**

Range	Resolution	Accuracy				
		30~45 Hz	45~1k Hz	1k~10k Hz	10k~20k Hz	20k~100k Hz
50mV	0.001mV	1.2%+80	0.4%+60	0.7%+60	1.5%+60	3.5%+220
500mV	0.01mV	1.2%+65	0.4%+30	0.4%+30	1.5%+45	3.5%+125
1000mV	0.1mV	1.2%+65	0.4%+30	0.4%+30	1.5%+45	3.5%+125
5V	0.0001V	1.2%+65	0.4%+30	0.4%+30	1.5%+45	3.5%+125
50V	0.001V	1.2%+65	0.4%+30	0.4%+30	1.5%+45	3.5%+125
500V	0.01V	1.2%+65	0.4%+30	0.4%+30	1.5%+45	3.5%+125*3
1000V	0.1V	1.2%+65	0.4%+45	0.4%+45	1.5%+45*3	No spec.

Notes:

1. Overload Protection: 1000V R.M.S.; 1000V R.M.S. for the circuits <0.3A short circuit for mV ranges.
2. Input Impedance: >1GΩ for 50mV~1000mV. 1.1MΩ (nominal) in parallel with <100pF for 5V~1000V ranges
3. Input voltage is lower than 200Vrms.
4. Crest factor<=3

**□ dB (decibel calculation)**

dB base	Reference	Default Reference
1mW (dBm)	1~9999Ω	600Ω
1V (dBV)	1V	1V

Notes:

1. The reading of dBm is indicated in decibels of power above or below 1mW, or decibels of voltage above or below 1V. The formula is according to voltage measurement and specified reference impedance. Its accuracy is depended on the accuracy of voltage measurement, and an additional calculation error of 0.3dB should be added.
2. Auto-ranging mode is used as selected decibel function.
3. The bandwidth is according to voltage measurement.

## □ DC CURRENT

Range	Resolution	Accuracy	Burden Voltage / Shunt	Overload Protection
500 $\mu$ A	0.01 $\mu$ A	0.05% +5 $\cdot$ N <sub>1</sub>	0.05V (100 $\Omega$ )	440mA 10x38mm AC/DC 1000V 30kA/ fast-acting 11A
5000 $\mu$ A	0.1 $\mu$ A	0.05% +5 $\cdot$ N <sub>1</sub>	0.5V (100 $\Omega$ )	
50mA	0.001mA	0.15% +5 $\cdot$ N <sub>1</sub>	0.08V (1 $\Omega$ )	
500mA	0.01mA	0.15% +5 $\cdot$ N <sub>1</sub>	0.8V (1 $\Omega$ )	
5A	0.0001A	0.2% +10	0.1V (0.01 $\Omega$ )	
10A $\cdot$ N <sub>2</sub>	0.0001A	0.2% +5	0.21V (0.01 $\Omega$ )	

### Notes:

- Always use relative function to zero thermal effect with open test lead before measuring the signal. If not use Relation function, additional 20 digits to the accuracy. The thermal effect could be occurred as follows:
  - Wrong operation to measure the high voltage of 50V~1000V for resistance, diode, and mV measurements.
  - After battery charging completed.
  - After measuring the current greater than 500mA, it is suggested to cool down the meter for two times of measuring time you applied.
- 10A continuous, and the additional of 0.5% to specified accuracy as measure the signal greater than 10A~20A for 30 seconds maximum. After measured current for > 10A, to cool down the meter for two times of measuring time you applied before low current measurement.

## □ AC CURRENT (TRUE RMS: From 5% to 100% of range)

Range	Resolution	Accuracy			
		20~45 Hz	45~2k Hz	2k~20k Hz	20k~100k Hz
500 $\mu$ A $\cdot$ N <sub>4</sub>	0.01 $\mu$ A	1.5% +50	0.7% +20	3% +80	5% +80
5000 $\mu$ A	0.1 $\mu$ A	1.5% +40	0.7% +20	3% +60	5% +80
50mA	0.001mA	1.5% +40	0.7% +20	3% +60	5% +80
500mA	0.01mA	1.5% +40	0.7% +20	3% +60	5% +80
5A	0.0001A	2% +40 $\cdot$ N <sub>3</sub>	0.7% +20	3% +60	No Spec.
10A $\cdot$ N <sub>2</sub>	0.0001A	2% +40 $\cdot$ N <sub>3</sub>	0.7% +20	<3A/ 5kHz	No Spec.

### Note:

- Overload protection: Fast-acting fuse 0.44A for < 500mA, and 11A for 5A/10A.
- 10A continuous, and the additional of 0.5% to specified accuracy as measure the signal greater than 10A~20A for 30 seconds maximum. After measured current for > 10A, to cool down the meter for two times of measuring time you applied before low current measurement.
- Input current < 3Arms
- Input current >35 $\mu$ Arms
- Crest factor<=3

**□ AC+DC CURRENT (TRUE RMS: From 5% to 100% of range.)**

Range	Resolution	Accuracy			Overload Protection
		30~45 Hz	45~2k Hz	2k~20k Hz	
500 $\mu$ A $\cdot$ N4	0.01 $\mu$ A	1.6% +55	0.8% +25	3.1% +85	440mA 10x38mm AC/DC 1000V 30kA/ fast-acting
5000 $\mu$ A	0.1 $\mu$ A	1.6% +45	0.8% +25	3.1% +65	
50mA	0.001mA	1.7% +45	0.9% +25	3.2% +65	
500mA	0.01mA	1.7% +45	0.9% +25	3.2% +65	
5A	0.0001A	2.2% +50 $\cdot$ N3	0.9% +30	3.2% +70	11A
10A $\cdot$ N2	0.0001A	2.2% +45 $\cdot$ N3	0.9% +25	<3A/5kHz	

Note:

1. Overload protection: Fast-acting fuse 0.44A for < 500mA, and 11A for 5A/10A.
2. 10A continuous, and the additional of 0.5% to specified accuracy as measure the signal greater than 10A~20A for 30 seconds maximum. After measured current for > 10A, to cool down the meter for two times of measuring time you applied before low current measurement.
3. Input current < 3Arms
4. Input current >35 $\mu$ Arms
5. Crest factor<=3

**□ PEAK HOLD (Capturing changes)**

Signal width	Accuracy for DC mV/ Voltage/ Current
Single event >1ms	2%+400 for all ranges
Repetitive >250 $\mu$ s	2%+1000 for all ranges

**□ RESISTANCE**

Range	Resolution	Accuracy	Test current	Overload Protection
500Ω *N3	0.01Ω	0.05% +10	1.0mA	1000V R.M.S. *N1
5kΩ *N3	0.0001kΩ	0.05% +5	0.38mA	
50kΩ	0.001kΩ		38μA	
500kΩ	0.01kΩ		3.8μA	
5MΩ	0.0001MΩ	0.15%+5	345nA	
50MΩ *N4	0.001MΩ	1% +5	200nA	
500MΩ	0.01MΩ	3%+10<200MΩ 8%+10>200MΩ	200nA	
500nS*N5	0.01nS	1%+10	200nA	

Notes:

1. Overload protection: 1000V R.M.S. for the circuits <0.3A short circuit.
2. Maximum open voltage: <+4.8V
3. The accuracy of 500Ω and 5kΩ is specified after Relative function, which is used to substrate the test lead resistance and the thermal effect.
4. For the range of 50MΩ, the RH is specified for < 60%.
5. The accuracy is specified for <50nS and after Relative function as open test lead.
6. Instant Continuity: Built-in buzzer sounds when resistance is less than 10.0Ω

**□ DIODE CHECK/ AUDIBLE CONTINUITY**

Range	Resolution	Accuracy	Test Current	Open Voltage
Diode	0.1 mV	0.05% +5	Approx. 1.0mA	<+4.8V DC

Notes:

1. Overload protection: 1000V R.M.S. for the circuits <0.3A short circuit.
2. Built-in buzzer sounds when reading is below 50 mV approx.

### **□ CAPACITANCE**

Range	Resolution	Accuracy	Measuring rate as full scale
10.000nF	0.001nF	1%+8	
100.00nF	0.01nF	1%+5	
1000.0nF	0.1nF		4 times/ sec.
10.000μF	0.001μF		
100.00μF	0.01μF		
1000.0μF	0.1μF		1 time/ sec.
10.000mF	0.001mF		0.1 times/ sec.
100.00mF	0.01mF	3%+10	0.01 times/ sec.

#### Notes:

1. Overload protection: 1000V R.M.S. for the circuits <0.3A short circuit.
2. With film capacitor or better, use Relative mode to zero residual.
3. Maximum display counts for each range is 11000 counts

### **□ TEMPERATURE**

Thermal Type	RANGE	Resolution	Accuracy
K	-200°C ~ 1372°C	0.1°C	0.3% +3°C
	-328°F ~ 2502°F	0.1°F	0.3% +6°F
J	-210°C ~ 1200°C	0.1°C	0.3% +3°C
	-346°F ~ 2192°F	0.1°F	0.3% +6°F

#### Notes:

1. The accuracy does not include the tolerance of thermocouple probe, and the thermal sensor plugged into the meter should be putting on the place will be operating for 1 hour at least.

**□ FREQUENCY**

Range	Resolution	Accuracy	Min. Input Freq.
99.999Hz	0.001Hz	0.02%+3  <600kHz	1Hz
999.99Hz	0.01Hz		
9.9999kHz	0.0001kHz		
99.999k Hz	0.001kHz		
999.99k Hz	0.01kHz		

- Overload protection: 1000V; <20,000,000VxHz

**Sensitivity for Voltage Measurement**

FREQUENCY SENSITIVITY AND TRIGGER LEVEL				
INPUT RANGE  (Maximum input for specified accuracy = 10 x Range or 1000V)	MINIMUM SENSITIVITY (RMS SINEWAVE)		Trigger Level for DC coupling	
	20 Hz-200 kHz	>200 kHz~ 500kHz	< 100 kHz	>100kHz ~ 500 kHz
50 mV	10mV	25mV	10mV	25mV
500 mV	70mV	150mV	70mV	150mV
1000mV	120mV	300mV	120mV	300mV
5V	0.3V	0.5V	0.6V	1.5V
50V	3V	5V	6V	15V
500V	30V< 100kHz	No. Spec	60V	No Spec.
1000V	50V <100kHz	No. Spec	120V	No Spec.

The accuracy for duty cycle and pulse width is based a 5V square wave input to the DC 5V range. For AC coupling, the duty cycle range can be measured within 5%~95% as the signal frequency >20Hz.

**DUTY CYCLE:**

MODE	RANGE	Accuracy of Full Scale
DC coupling	0.01%~99.99%	0.3% per kHz+0.3%

**PULSE WIDTH:**

RANGE	Resolution	Accuracy
500ms	0.01ms	0.2%+3
2000ms	0.1ms	0.2%+3

Notes:

Positive or negative pulse width must be greater than 10μs and the range of duty cycle should be considered. The range of pulse width is determined by the frequency of the signal.

### Sensitivity for Current Measurement

Input Range	Minimum Sensitivity (RMS Sine-wave)
	20Hz~20kHz
500 $\mu$ A	100 $\mu$ A
5000 $\mu$ A	250 $\mu$ A
50mA	10mA
500mA	25mA
5A	1A
10A	2.5A

- Maximum input, please refer to AC Current measurement.



## **□ FREQUENCY COUNTER**

### **Divide 1 (secondary display "- 1 -")**

Range	Resolution	Accuracy	Sensitivity	Min. Input Freq.
99.999Hz	0.001Hz	0.002%+5	100mV R.M.S.	0.5Hz
999.99Hz	0.01Hz			
9.9999kHz	0.0001kHz			
99.999k Hz	0.001kHz			
999.99k Hz	0.01kHz	<2MHz	200mV R.M.S.	
9.9999MHz	0.0001MHz			

### **Divide 100 (secondary display "-100-")**

Range	Resolution	Accuracy	Sensitivity	Min. Input Freq.
9.9999MHz	0.0001MHz	0.002%+5	300m V R.M.S	1MHz
99.999MHz	0.001MHz	<20MHz	500mV R.M.S	

Notes:

1. The maximum measurement level is < 30Vpp.
2. The minimum measurement frequency of Low frequency is set by Power-ON option to speed up the measuring rate.
3. All frequency counters are susceptible to error when measuring low-voltage, low-frequency signals. Shielding inputs from external noise pickup is critical for minimizing measurement errors
4. The accuracy for duty cycle and pulse width is based a 5V square wave input without dividing signal.

### **DUTY CYCLE:**

<b>RANGE</b>	<b>Accuracy of Full Scale</b>
0.01%~99.99%	0.3% per kHz+0.3%

### **PULSE WIDTH:**

<b>RANGE</b>	<b>Resolution</b>	<b>Accuracy</b>
500ms	0.01ms	0.2%+3
2000ms	0.1ms	0.2%+3

Note: Positive or negative pulse width must be greater than 10µs and the range of duty cycle should be considered. The range of pulse width is determined by the frequency of the signal.

## □ SQUARE WAVE OUTPUT

OUTPUT	Range	Resolution	Accuracy
Frequency	0.5, 1, 2, 5, 10, 15, 20, 25, 30, 40, 50, 60, 75, 80, 100, 120, 150, 200, 240, 300, 400, 480, 600, 800, 1200, 1600, 2400, 4800 Hz	0.01Hz	0.005 % +2
Duty cycle *N1	0.39% ~ 99.60 %	0.390625%	0.4% of full scale *N3
Pulse width *N1	1 / Frequency	Range/256	0.2ms+ Range/256
Amplitude	Fixed 0~+2.8V	0.1V	0.2V

### NOTE:

1. The plus or minus pulse width must be greater than 50  $\mu$ s for adjusting the duty cycle or pulse width under different frequency. Else, the accuracy and range will be different to definition.
2. Output impedance: 3.5k $\Omega$  maximum.
3. For signal frequency greater than 1 kHz, additional 0.1% per kHz to be added to accuracy.

## ■ ELECTRICAL SPECIFICATIONS FOR MODEL 2880B

Accuracy is given as  $\pm$ (% of reading + counts of least significant digit) at 23°C  $\pm$  5°C, with relative humidity Less than 80% R.H.

### □ DC mV/ Voltage

Range	Resolution	Accuracy	Overload Protection
50mV	0.001mV	0.05% +50 *N2	1000V for the circuits <0.3A short circuit.
500mV	0.01mV	0.03% +5	
1000mV	0.1mV		
5V	0.0001V		
50V	0.001V		
500V	0.01V		
1000V	0.1V		1000V

Notes:

- Input impedance: >1G $\Omega$  for 50mV~1000mV ranges. For 5V~1000V ranges, 10M $\Omega$  (nominal) for single display and parallel connected with 1.1M $\Omega$  as dual display.
- The accuracy could be 0.05%+5, always use relative function to zero thermal effect (short test leads) before measuring the signal.

### □ AC mV/ V (TRUE RMS: From 5% to 100% of range)

Range	Resolution	Accuracy			
		30~45 Hz	45~1k Hz	1k~10k Hz	10k~30k Hz
50mV	0.001mV	1%+60	0.6%+40	1.0%+40	1.6%+60
500mV	0.01mV	1%+60	0.6%+25	1.0%+40	1.6%+60
1000mV	0.1mV	1%+60	0.6%+25	1.0%+25	1.6%+40
5V	0.0001V	1%+60	0.6%+25	1.0%+25	1.6%+40
50V	0.001V	1%+60	0.6%+25	1.0%+25	1.6%+40
500V	0.01V	1%+60	0.6%+25	1.0%+25	1.6%+40
1000V	0.1V	1%+60	0.6%+40	1.0%+40	No SPEC.

Notes:

- Overload Protection: 1000V R.M.S.; 1000V R.M.S. for the circuits <0.3A short circuit for mV ranges.
- Input impedance: >1G $\Omega$  for 50mV~1000mV. 1.1M $\Omega$  (nominal) in parallel with <100pF for 5V~1000V ranges
- Input voltage is lower than 200Vrms.
- Crest factor  $\leq$  3

**□ dB (decibel calculation)**

<b>dB base</b>	<b>Reference</b>	<b>Default Reference</b>
1mW (dBm)	1~9999Ω	600Ω
1V (dBV)	1V	1V

Notes:

4. The reading of dBm is indicated in decibels of power above or below 1mW, or decibels of voltage above or below 1V. The formula is according to voltage measurement and specified reference impedance. Its accuracy is depended on the accuracy of voltage measurement, and an additional calculation error of 0.3dB should be added.
5. Auto-ranging mode is used as selected decibel function.
6. The bandwidth is according to voltage measurement.

**□ PEAK HOLD (Capturing changes)**

<b>Signal width</b>	<b>Accuracy for DC mV/ Voltage/ Current</b>
Single event >1ms	2%+400 for all ranges
Repetitive >250μs	2%+1000 for all ranges

**□ DC CURRENT**

Range	Resolution	Accuracy	Burden Voltage / Shunt	Overload Protection
500 $\mu$ A	0.01 $\mu$ A	0.1% +5 $\cdot$ N <sub>1</sub>	0.06V (100 $\Omega$ )	440mA 10x38mm AC/DC 1000V 30kA/ fast-acting
5000 $\mu$ A	0.1 $\mu$ A	0.1% +5 $\cdot$ N <sub>1</sub>	0.6V (100 $\Omega$ )	
50mA	0.001mA	0.2% +5 $\cdot$ N <sub>1</sub>	0.09V (1 $\Omega$ )	
500mA	0.01mA	0.2% +5 $\cdot$ N <sub>1</sub>	0.9V (1 $\Omega$ )	
5A	0.0001A	0.2% +10	0.2V (0.01 $\Omega$ )	11A
10A $\cdot$ N <sub>2</sub>	0.0001A	0.2% +10	0.4V (0.01 $\Omega$ )	

Notes:

3. Always use relative function to zero thermal effect with open test lead before measuring the signal. If not use Relation function, additional 20 digits to the accuracy. The thermal effect could be occurred as follows:
  - Wrong operation to measure the high voltage of 50V~1000V for resistance, diode, and mV measurements.
  - After battery charging completed.
  - After measuring the current greater than 500mA, it is suggested to cool down the meter for two times of measuring time you applied.
4. 10A continuous, and the additional of 0.5% to specified accuracy as measure the signal greater than 10A~20A for 30 seconds maximum. After measured current for > 10A, to cool down the meter for two times of measuring time you applied before low current measurement.

**□ AC CURRENT (TRUE RMS: From 5% to 100% of range)**

Range	Resolution	Accuracy		
		30~45 Hz	45~2k Hz	2k~20k Hz
500 $\mu$ A $\cdot$ N <sub>4</sub>	0.01 $\mu$ A	1.5% +50	0.8% +20	3% +80
5000 $\mu$ A	0.1 $\mu$ A	1.5% +40	0.8% +20	3% +60
50mA	0.001mA	1.5% +40	0.8% +20	3% +60
500mA	0.01mA	1.5% +40	0.8% +20	3% +60
5A	0.0001A	2% +40 $\cdot$ N <sub>3</sub>	0.8% +20	3% +60
10A $\cdot$ N <sub>2</sub>	0.0001A	2% +40 $\cdot$ N <sub>3</sub>	0.8% +20	<3A/5kHz

Note:

6. Overload protection: Fast-acting fuse 0.44A for < 500mA, and 11A for 5A/10A.
7. 10A continuous, and the additional of 0.5% to specified accuracy as measure the signal greater than 10A~20A for 30 seconds maximum. After measuring > 10A, to cool down the meter for two times of measuring time you applied before low current measurement.
8. Input current < 3Arms
9. Input current >35 $\mu$ Arms
10. Crest factor<=3

## **□ RESISTANCE**

Range	Resolution	Accuracy	Test current	Overload Protection
500Ω *N3	0.01Ω	0.08% +10	1.0mA	1000V R.M.S. *N1
5kΩ *N3	0.0001kΩ	0.08% +5	0.38mA	
50kΩ	0.001kΩ		38μA	
500kΩ	0.01kΩ		3.8μA	
5MΩ	0.0001MΩ	0.2%+5	345nA	
50MΩ *N4	0.001MΩ	1% +5	200nA	
500nS *N5	0.01nS	1%+10	200nA	

### Notes:

1. Overload protection: 1000V R.M.S. for the circuits <0.3A short circuit.
2. Maximum open voltage: <+4.8V
3. The accuracy of 500Ω and 5kΩ is specified after Relative function, which is used to substrate the test lead resistance and the thermal effect.
4. For the range of 50MΩ, the RH is specified for < 60%.
5. The accuracy is specified for <50nS and after Relative function as open test lead.
6. Instant Continuity: Built-in buzzer sounds when resistance is less than 10.0Ω

## **□ DIODE CHECK/ AUDIBLE CONTINUITY**

Range	Resolution	Accuracy	Test Current	Open Voltage
Diode	0.1 mV	0.05% +5	Approx. 1.0mA	<+4.8V DC

### Notes:

3. Overload protection: 1000V R.M.S. for the circuits <0.3A short circuit.
4. Built-in buzzer sounds when reading is below 50 mV approx.

**□ CAPACITANCE**

Range	Resolution	Accuracy	Measuring rate as full scale
10.000nF	0.001nF	1%+8	4 times/ sec.
100.00nF	0.01nF	1%+5	
1000.0nF	0.1nF		
10.000μF	0.001μF		
100.00μF	0.01μF		
1000.0μF	0.1μF		
10.000mF	0.001mF		0.1 times/ sec.
100.00mF	0.01mF	3%+10	0.01 times/ sec.

Notes:

4. Overload protection: 1000V R.M.S. for the circuits <0.3A short circuit.
5. With film capacitor or better, use Relative mode to zero residual.
6. Maximum display counts for each range is 11000 counts

**□ TEMPERATURE (requires optional adapter)**

Thermal Type	RANGE	Resolution	Accuracy
K	-200°C ~ 1372°C	0.1°C	0.3% +3°C
	-328°F ~ 2502°F	0.1°F	0.3% +6°F

Notes:

2. The accuracy does not include the tolerance of thermocouple probe, and the thermal sensor plugged into the meter should be putting on the place will be operating for 1 hour at least.

**□ FREQUENCY**

Range	Resolution	Accuracy	Min. Input Freq.
99.999Hz	0.001Hz	0.02%+3  <600kHz	1Hz
999.99Hz	0.01Hz		
9.9999kHz	0.0001kHz		
99.999k Hz	0.001kHz		
999.99k Hz	0.01kHz		

- Overload protection: 1000V; <20,000,000VxHz

**Sensitivity for Voltage Measurement**

FREQUENCY SENSITIVITY AND TRIGGER LEVEL				
INPUT RANGE  (Maximum input for specified accuracy = 10 x Range or 1000V)	MINIMUM SENSITIVITY (RMS SINEWAVE)		Trigger Level for DC coupling	
	20 Hz-100 kHz	>100kHz ~ 200 kHz	< 100 kHz	>100kHz ~ 200 kHz
50 mV	10mV	15mV	10mV	15mV
500 mV	25mV	35mV	60mV	70mV
1000mV	40mV	50mV	100mV	150mV
5V	0.25V	0.5V	0.5V/ 1.25V<100Hz	0.6V
50V	2.5V	5V	5V	6V
500V	25V	No. Spec	50V	No Spec.
1000V	50V	No. Spec	300V	No Spec.

The accuracy for duty cycle and pulse width is based a 5V square wave input to the DC 5V range. For AC coupling, the duty cycle range can be measured within 5%~95% as the signal frequency >20Hz.

**DUTY CYCLE:**

MODE	RANGE	Accuracy of Full Scale
DC coupling	0.01%~99.99%	0.3% per kHz+0.3%

**PULSE WIDTH:**

RANGE	Resolution	Accuracy
500ms	0.01ms	0.2%+3
2000ms	0.1ms	0.2%+3

Positive or negative pulse width must be greater than 10µs and the range of duty cycle should be considered. The range of pulse width is determined by the frequency of the signal.

**Sensitivity for Current Measurement**

Input Range	Minimum Sensitivity (RMS Sine-wave)
	20Hz~20kHz
500µA	100µA
5000µA	250µA
50mA	10mA
500mA	25mA
5A	1A
10A	2.5A

- Maximum input, please refer to AC Current measurement.

**Important:** Specifications and information is subject to change without notice. For the latest current product information please visit [www.bkprecision.com](http://www.bkprecision.com)



## MAINTENANCE

**⚠ WARNING**

**To avoid electrical shock, do not perform any service unless you are qualified to do so.**

### ■ SERVICE

If the instrument fails to operate, check battery and test leads, and replaces them if necessary. If the instrument still can't work, double check operating procedure as described in this instruction manual. When servicing, use specified replacement parts only. Following table will guide you to identify basic problems:

Malfunction	Identification
No LCD indication as power ON by rotary switch	<ul style="list-style-type: none"><li>• Check battery and charge or replace battery.</li></ul>
No beeper tone	<ul style="list-style-type: none"><li>• Check setup mode whether the beeper has been set to OFF. Then select the driving frequency you want</li></ul>
Failed on current measuring	<ul style="list-style-type: none"><li>• Check Fuse</li></ul>
No charging indication	<ul style="list-style-type: none"><li>• Check external adaptor whether the output is DC 24V and plug into the charging terminals completely.</li><li>• Line power voltage (100V~250V AC 47Hz~ 63Hz) and power cord</li></ul>
Failed on Remote control	<ul style="list-style-type: none"><li>• The optical side of cable connected to meter, the text side of cover should be up.</li><li>• Check the baud rate, parity, Data bit, Stop bit (default is 9600, n, 8, 1)</li><li>• Driver install for USB- RS232.</li></ul>

■ **BATTERY REPLACEMENT** (unit does not come with a Ni-MH battery)

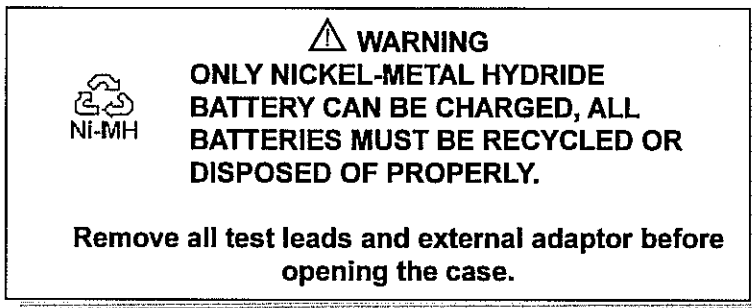

The meter is powered by 9 V battery, be sure to used specified battery. To ensure the specification specified, it is suggested to replace battery immediately as the sign of **B** low battery is displayed and flashing. If your meter has specified rechargeable battery inside, please go to [how to charge battery](#). Following procedures for battery replacement:

1. Remove protective Holster.

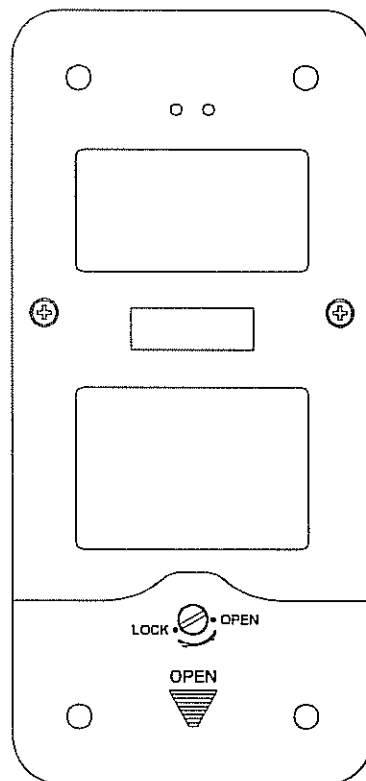

2. Turn the screw on the battery cover from LOCK to OPEN position by counterclockwise.

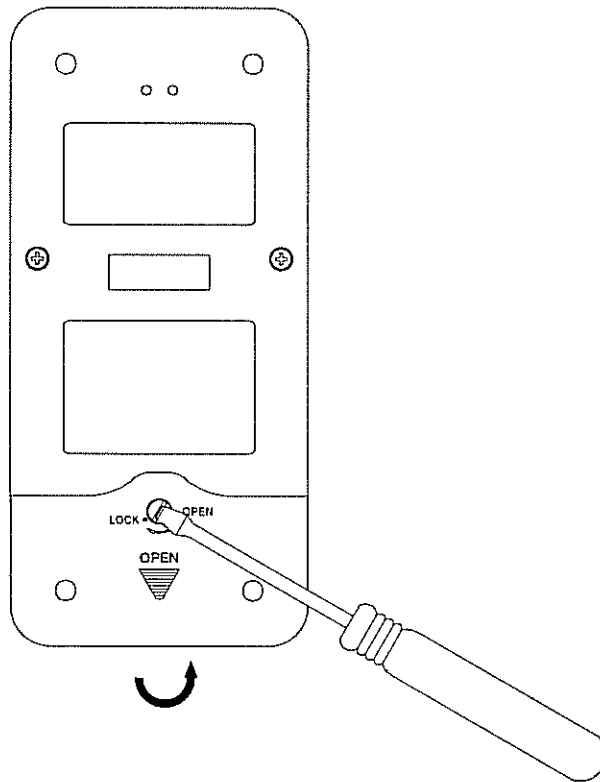

3. Slide pull down the battery cover. See below figure:

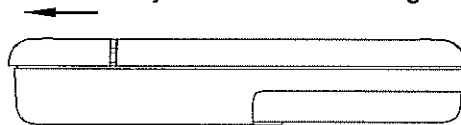

4. Then take up the cover.

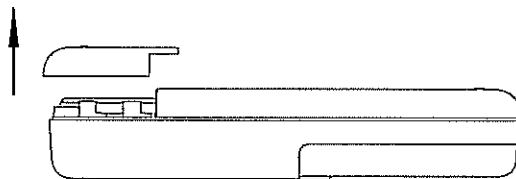

5. Replace the specified battery.
6. Reverse the procedure of opening cover to close the bottom cover.

## ■ HOW TO CHARGE BATTERY (optional accessory required)

### ⚠ WARNING

Never discharge the battery by short battery or reverse polarity in any subjects. Always check whether the battery is rechargeable battery before charging battery. Never rotate the rotary switch under charging as DC 24V has been applied to charging terminals.

The meter can be powered by a 9V NiMH rechargeable battery. You must use the specified optional accessory 24V DC adaptor to charge a rechargeable battery. **IMPORTANT:** Never rotate the rotary switch as the DC 24V has been applied to the charging terminals. Use the following procedures to charge the battery:

1. Remove and disconnect the test leads from meter.
2. Turn rotary switch to the "OFF" position. Plug power cord to DC adapter.
3. Plug the Red (+) banana terminal of DC adapter to **POSITIVE** and the Black (-) banana terminal of DC adapter to **COM** terminals, respectively. The DC adaptor can be replaced by a DC power supply, to set DC24V output and over current limitation set to <0.5A. Be sure the polarity. See the below figure:



Figure- 65 Charge battery

4. The primary display will indicate existing battery level, and the "SBY" is flashing on second display and short tone sounds to remind you whether to charge battery or not. If you want to charge battery, just one touch by pushing "SHIFT" button to start charging procedures. It is suggested never charge the battery as the battery voltage is over 9.0V.

Condition	Battery Voltage	Proportional Percentage
Trickle	6V~10.0V	0%~100%
Under charging	8.4~11.4V	0%~100%

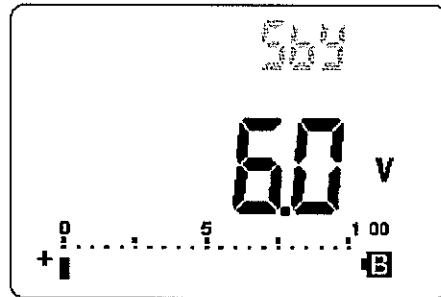

Figure- 66 Battery capacity display as trickle

- The meter will do self-test to check whether inside battery is rechargeable or not. The self-test will take 2~3 minutes, no pushbuttons can be operated in this period. If something wrong, the error message will be indicated as following:

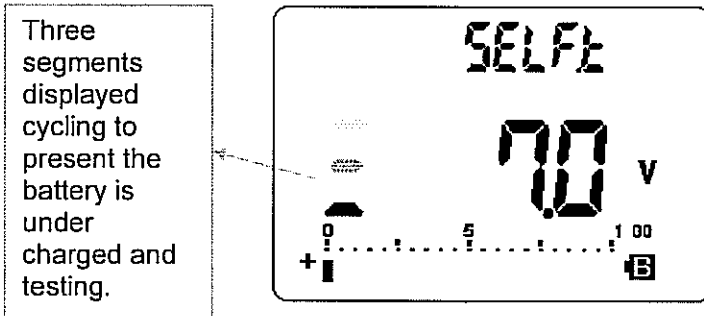

Figure- 67 Self-test

Error Condition	Secondary Display
<b>OL</b> 1. No battery inside 2. Failed battery 3. Battery is full	
<b>C-Err</b> 1. Non rechargeable battery inside 2. Failed battery	

Figure- 68 Error message

If such error message occurred, check whether the battery is specified one. We have done best recognition as possible as we can to prevent wrong battery to be charged. Maybe some batteries from different manufactures have bad quality. Please make sure the battery is specified rechargeable battery before starting charge function again.

Once the specified rechargeable battery has been used, press "SHIFT"

button to do self test again. If the C-Err still occurred, replace with a new battery.

- The smart charging mode will be started if passed self-test. The charge time is limited within 135 minutes. That means the battery will not be charged over 135 minutes. The secondary display will count down the charging time. You can expect when the battery will be fully charged. During charging period, no pushbuttons can be operated. The error message maybe indicated during charge period to prevent overcharging on the battery.

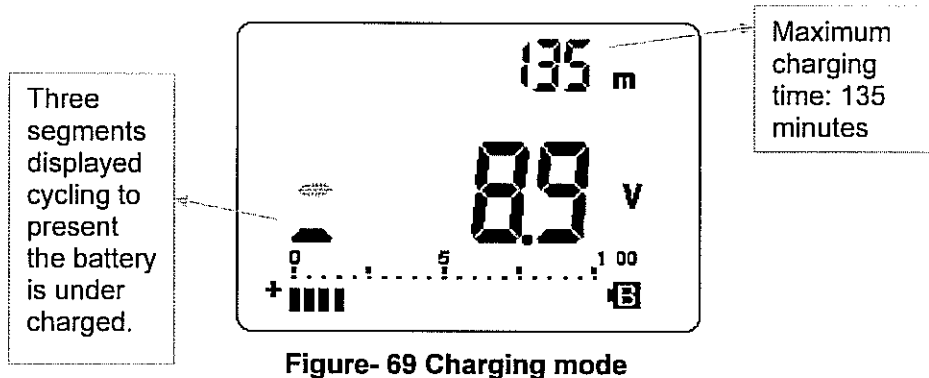

- The charge end message (C-End) will be indicated on secondary display as the charging cycle has been finished. The trickle charging current still be provided to keep the battery capacity. The signs of  $\sqcap$  and  $\sqcup$  will be cycling display to present the trickle state.

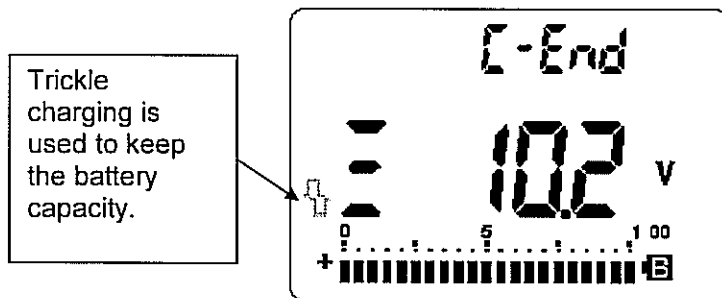

- Usually, the battery has been fully charged. If you feel the battery life as worst as you can't acceptable. Please replace a new rechargeable battery.
- Remove the DC adapter when the C-End is indicated on secondary display. Don't turn the rotary switch before removed the adapter from terminals.

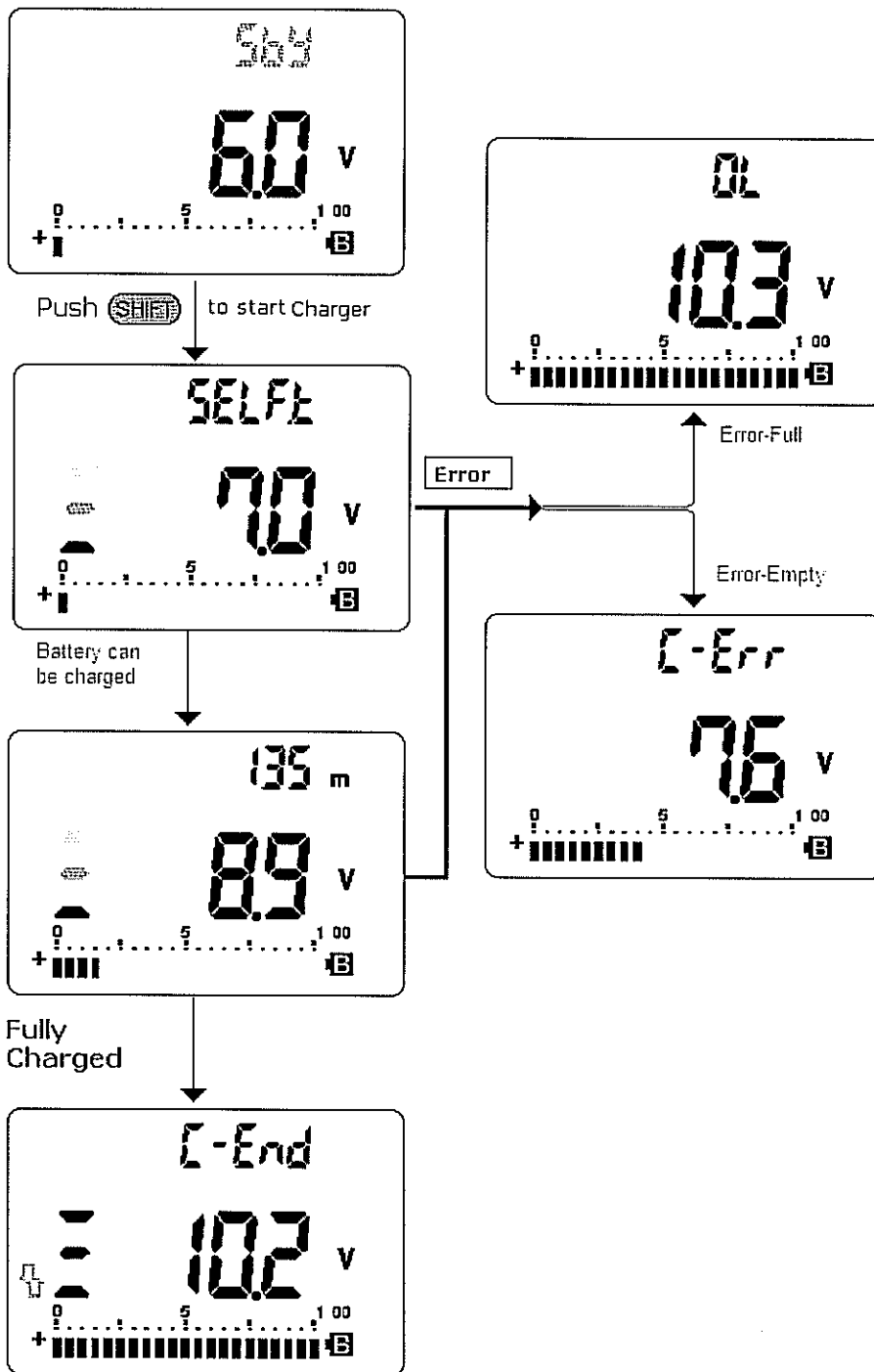

Figure- 71 Battery charging procedures



## ■ FUSE REPLACEMENT

Use the following procedures to replace the fuses of the meter:

1. Use the rotary switch to turn the meter off, and disconnect the test leads from external equipment. Be sure the adaptor has been removed.
2. Remove the cover of battery compartment as Fuse replacement.
3. Loosen 3 screws on bottom case, pull up and remove the cover.
4. Lift the circuit board as shown in following figure.
5. Remove the defective fuse by gently prying one end of the fuse loose and sliding the fuse out of the fuse bracket.
6. Install a new fuse of the same size and rating. Make sure the new fuse is centered in the fuse holder.
7. Ensure that the rotary switch on the top case and circuit board switch stay on the **OFF** position.
8. Then re-fasten the circuit board and the bottom cover respectively.
9. The rate, position and size for fuses see the below table.

POSITION	RATING	SIZE	Type
Fuse1	440mA/1000V	10x38	Fast blow
Fuse2	11A/1000V	10x38	Fuse

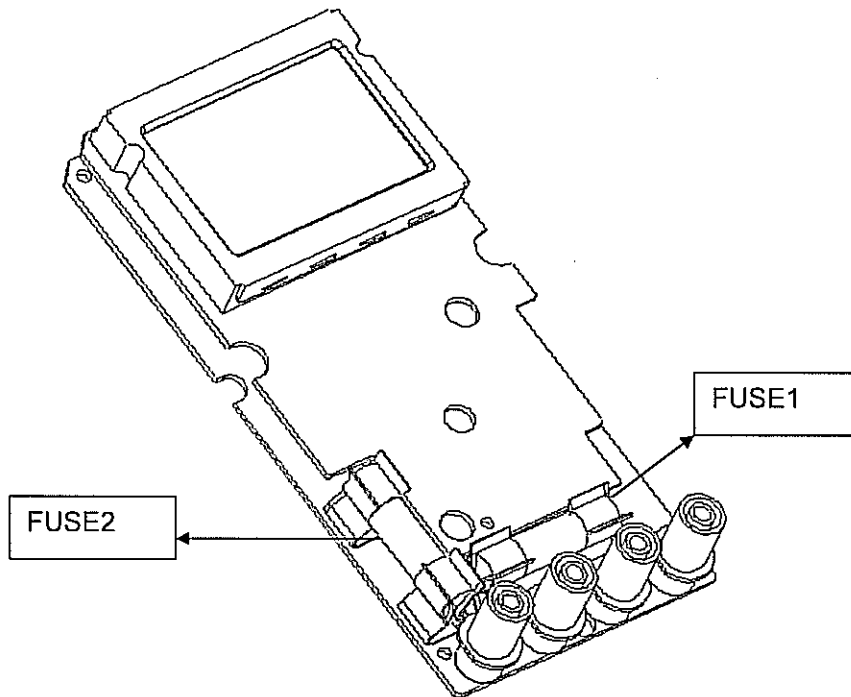

Figure- 72 Fuse replacement

## ■ **CLEANING**

 **WARNING**

**To avoid electrical shock or damage to the meter, do not get water inside the case.**

To clean the instrument, use a soft cloth dampened in a solution of mild detergent and water. Do not spray cleaner directly onto the instrument, since it may leak into the cabinet and cause damage. Do not use chemicals containing benzene, benzene, toluene, xylene, acetone or similar solvents to clean the instrument. After cleaning, make sure the instrument is dried completely before using.



### Service Information

**Warranty Service:** Please return the product in the original packaging with proof of purchase to the address below. Clearly state in writing the performance problem and return any leads, probes, connectors and accessories that you are using with the device.

**Non-Warranty Service:** Return the product in the original packaging to the address below. Clearly state in writing the performance problem and return any leads, probes, connectors and accessories that you are using with the device. Customers not on open account must include payment in the form of a money order or credit card. For the most current repair charges please visit [www.bkprecision.com](http://www.bkprecision.com) and click on "service/repair".

Return all merchandise to B&K Precision Corp. with pre-paid shipping. The flat-rate repair charge for Non-Warranty Service does not include return shipping. Return shipping to locations in North American is included for Warranty Service. For overnight shipments and non-North American shipping fees please contact B&K Precision Corp.

B&K Precision Corp.  
22820 Savi Ranch Parkway  
Yorba Linda, CA 92887  
[www.bkprecision.com](http://www.bkprecision.com)  
714-921-9095

*Include with the returned instrument your complete return shipping address, contact name, phone number and description of problem.*

### Limited Three-Year Warranty

B&K Precision Corp. warrants to the original purchaser that its products and the component parts thereof, will be free from defects in workmanship and materials for a period of three years from date of purchase.

B&K Precision Corp. will, without charge, repair or replace, at its option, defective product or component parts. Returned product must be accompanied by proof of the purchase date in the form of a sales receipt.

To obtain warranty coverage in the U.S.A., this product must be registered by completing a warranty registration form on [www.bkprecision.com](http://www.bkprecision.com) within fifteen (15) days of purchase.

**Exclusions: This warranty does not apply in the event of misuse or abuse of the product or as a result of unauthorized alterations or repairs. The warranty is void if the serial number is altered, defaced or removed.**

B&K Precision Corp. shall not be liable for any consequential damages, including without limitation damages resulting from loss of use. Some states do not allow limitations of incidental or consequential damages. So the above limitation or exclusion may not apply to you.

This warranty gives you specific rights and you may have other rights, which vary from state-to-state.

B&K Precision Corp.  
22820 Savi Ranch Parkway  
Yorba Linda, CA 92887  
[www.bkprecision.com](http://www.bkprecision.com)  
714-921-9095



PN: 481-549-9-001  
Printed in Taiwan  
©2006 B&K Precision Corp.

22820 Savi Ranch Parkway  
Yorba Linda, CA 92887  
USA  
TEL: 714-921-9095  
FAX: 714-921-6422  
**[www.bkprecision.com](http://www.bkprecision.com)**